

**TEXT FLY WITHIN
THE BOOK ONLY**

UNIVERSAL
LIBRARY

OU_160527

UNIVERSAL
LIBRARY

PRINCIPLES OF ANIMAL BIOLOGY

Professor Hogben's textbook was originally published in 1930. He has completely revised and rewritten the later chapters. Most of the illustrations have been re-drawn by Mr. J. F. Horrabin. The unique combination which was so successful in *Science for the Citizen* and *Mathematics for the Million* is therefore repeated here; the combination of Professor Hogben's extreme care and brilliant teaching technique in devising diagrams and dissections with Mr. Horrabin's beautiful lettering and line in executing the drawings.

The book has been brought up to date to cover the latest advances in research. The new edition also shows how much one of our greatest teachers has developed his teaching technique since the work first appeared. The experience gained, not only in the lecture-hall and laboratory but in the colossal teaching experiments *Science for the Citizen* and *Mathematics for the Million*, is applied in this new edition.

The book is for the upper forms of schools and for universities, polytechnics, and private students. A textbook by an outstanding research worker who is also a brilliant teacher is rare.

by LANCELOT HOGBEN

MATHEMATICS FOR THE MILLION

Demy 8vo Illustrated by J. F. Horrabin 12s. 6d. net

16th Printing

"One of the indispensable works of popularization
our generation has produced." *H. J. Laski*

SCIENCE FOR THE CITIZEN

Small Royal 8vo. Illustrated by J. F. Horrabin 16s. net

7th Printing

"The civilized world is indebted to him." *The
Spectator*

DANGEROUS THOUGHTS

Demy 8vo.

8s. 6d. net

"Of instant importance for the present and future
of Western civilization." *Storm Jameson*

NATURE AND NURTURE

Demy 8vo.

6s. 6d. net

GENETIC PRINCIPLES IN MEDICINE AND SOCIAL SERVICE

Demy 8vo.

15s. net

EDITED AND ARRANGED BY

LANCELOT HOGBEN

THE LOOM OF LANGUAGE

A GUIDE TO FOREIGN LANGUAGES FOR
THE HOME STUDENT

by FREDERICK BODMER

Demy 8vo.

15s. net

EDITED BY LANCELOT HOGBEN

POLITICAL ARITHMETIC

Royal 8vo.

30s. net

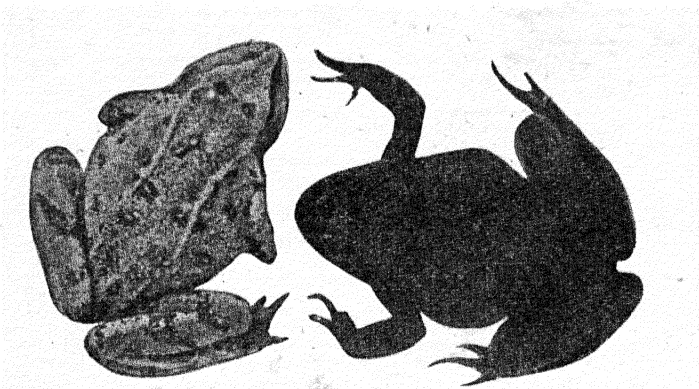

TWO EXTREMES OF COLOUR CHANGE IN THE COMMON FROG

Showing the influence of pituitary hormone on colour-change in frogs. *Left*—Control specimen, in dry, light surroundings. *Right*—Specimen kept in the same surroundings, but injected with extract of ox-pituitary (posterior lobe). (See Chapter VI.)

PRINCIPLES OF
ANIMAL BIOLOGY

BY

LANCELOT HOGBEN, F.R.S.

MASON PROFESSOR OF ZOOLOGY IN THE UNIVERSITY
OF BIRMINGHAM, FORMERLY REGIUS PROFESSOR OF
NATURAL HISTORY IN THE UNIVERSITY OF ABERDEEN,
RESEARCH PROFESSOR OF SOCIAL BIOLOGY IN THE
UNIVERSITY OF LONDON, AND PROFESSOR OF
ZOOLOGY IN THE UNIVERSITY OF CAPE TOWN

SECOND EDITION

revised and with new illustrations
throughout by

J. F. HERRABIN

LONDON
GEORGE ALLEN & UNWIN LTD
MUSEUM STREET

First published in 1930 by Christophers, Ltd.
COMPLETELY REVISED SECOND EDITION 1940
REPRINTED 1942
REPRINTED 1945

COMPLETE CONFORMITY WITH THE
AUTHORIZED ECONOMY STANDARDS

ALL RIGHTS RESERVED
PRINTED IN GREAT BRITAIN
in 11-Point Imprint Type
BY UNWIN BROTHERS LIMITED
WOKING

PREFACE TO SECOND EDITION

PRINCIPLES OF ANIMAL BIOLOGY was published first in 1930. It was based on the plan of elementary instruction adopted in the University of Cape Town during the author's tenure of the chair of zoology. Its object was not then, and is not now, to supplant the many excellent dissecting manuals available for use in the laboratory. It aims at supplementing laboratory work with a general introduction based on evolutionary principles with emphasis on function throughout.

While the original plan remains, each chapter has been extensively revised or, where necessary, entirely rewritten. The chapter in which the Vertebrate skeleton is used to illustrate the principles of geological succession by reference to the fossil record has been recast to take advantage of the many new discoveries which have been made during the past ten years. The author is greatly indebted to Dr. Westoll, Lecturer in Palæontology in the University of Aberdeen, for advice and information, especially with reference to the design of new illustrations. All the illustrations in the previous edition have been redrawn by Mr. Horrabin, and many new ones have been added or substituted. To help students to practise methodical methods of memorizing essential facts new tabular matter has been introduced in various places.

Dr. H. Waring who saw the new edition through the press is responsible for many valuable suggestions.

THE UNIVERSITY
ABERDEEN

LANCELOT HOGBEN

Nov. 1939

CONTENTS

PART I

The Vertebrate Body as a Going Concern

CHAPTER	PAGE
I. LIVING MATTER AND REPRODUCTION	15
II. THE MACHINERY OF RESPONSE	45
III. THE MACHINERY OF CO-ORDINATION	73
IV. THE SOURCES OF ENERGY OF THE ANIMAL BODY	98
V. DIGESTION, RESPIRATION AND EXCRETION	114
VI. THE TRANSPORT OF MATERIALS IN THE ANIMAL BODY	129
VII. THE DEVELOPMENT OF A NEW ORGANISM	155
VIII. THE MACHINERY OF INHERITANCE	186

PART II

How Animals Differ

IX. THE DIVERSITY OF ANIMAL LIFE	245
X. THE PRINCIPLE OF UNITY OF TYPE	271
XI. UNITY OF TYPE AMONG INVERTEBRATES	291
XII. THE PRINCIPLE OF SUCCESSION WITH SPECIAL REFERENCE TO THE VERTEBRATE SKELETON	331
XIII. EVOLUTIONARY THEORY TO-DAY	367
APPENDIX I. CLASSIFICATION OF CRUSTACEA	389
APPENDIX II. KEYS TO THE ORDERS OF INSECTS	394
APPENDIX III. SERIAL HOMOLOGY	400
APPENDIX IV. PARTS OF THE BRAIN	403
INDEX	405

ILLUSTRATIONS

Two Extremes of Colour Change in the Common Frog

Frontispiece

FIG.		PAGE
1.	Set-up of Experiment to show the Dependence of the Heart-beat on Metallic Ions	16
2.	Paramœcium Dividing	23
3.	Reproductive and Associated Organs of the Frog	24
4.	Fertilization in the Starfish	25
5.	Human Egg and Sperm	26
6.	Spermatozoa of Different Animals	27
7.	Stages in the Development of the Frog's Egg	28
8.	Cellular Structure of the Animal Body	29
9.	The Cellular Structure of the Testis	31
10.	Immature Ova of Different Vertebrate Types	33
11.	Early Stages in the Segmentation of the Egg of the Sea Urchin, Sturgeon and Fowl	36
12.	Genital Organs of Man with Associated Structures	37
13.	Black Pigment Cells (Melanophores) from Web of Foot of Frog	46
14.	Stages in "Expansion" of Melanophores	48
15.	Microscopic Structure of Muscle	50
16.	Relation of Muscle and Skeletal Parts	51
17.	The Skeleton of a Frog	53
18.	Comparison of the Microscopic Appearance of Cartilage and Bone	54
19.	Muscle Contraction	56
20.	Glands	58
21.	Ciliated Columnar Epithelium	59
22.	Diagram of Ciliary Motion	60
23.	Diagram to show Ciliary Currents in the Gill Chamber of the Mussel	61
24.	Gill of the Mussel	62
25.	Vertebrate Eye	64

FIG.		PAGE
26.	The Vertebrate Eye <i>in situ</i>	65
27.	Diagrammatic View of the Eye of <i>Xenopus</i> to show Regions stimulated by Overhead Illumination in Different Situations	67
28.	The Human Ear	69
29.	Diagrammatic Half-section through Head of Frog	70
30.	Diagram to show Displacement of Statolith in the Statocyst of a Shrimp or Squid	71
31.	Apparatus for determining the Speed of the Nervous Impulse	76
32.	The Speed of the Nervous Impulse	77
33.	Motor (efferent) and Sensory (afferent) Nerve Endings in Striped Muscle	80
34.	Diagram to illustrate Müller's Experiment	81
35.	Diagram to illustrate Effect of Degenerative Section of Nerve Roots	83
36.	Diagram of the Reflex Arc	84
37.	Effect of Faradic Stimulation of the Roof of the Mouth in the Cape Chameleon when the Spinal Cord is severed	85
38.	Brain of Frog	86
39.	Diagrammatic Representation of the Central Nervous System of Man	89
40.	Diagrammatic Representation of the Nerve Paths in- volved in the Control of the Pigmentary Effector System of the Chameleon	90
41.	Diagram of the Human Retina	91
42.	Diagram to illustrate Movement of Insect (Hover Fly) towards the Light	93
43.	Alimentary Canal and Associated Structures in the Frog	115
44.	The Alimentary Canal, its Associated Structures, and the Lungs in Man	116
45.	Respiratory Organs of Frog and Man	123
46.	Diagrammatic Representation of the Kidney of the Frog	125

ILLUSTRATIONS

9

FIG.		PAGE
47.	Apparatus for Measuring the Oxygen Consumption of a Worm or other Small Organism	127
48.	Diagram of Vein showing Valves	130
49.	Diagram of the Main Paths in the Human Blood System	132
50.	Principal Arteries of the Frog	133
51.	Main Veins of Frog and Man	135
52.	The Heart of the Frog	136
53.	Physical Model to illustrate Resistance of the Capillaries to Arterial Pressure	139
54.	The Relation of the Heart to the Lungs and Tissues	141
54A.	Blood Supply of Small Intestine	143
55.	Diagram of Gill Arches and Heart of a Typical Fish, and Tadpole or Lung Fish	144
56.	Blood System of a Fish	145
57.	Diagrammatic Representation of the Oxygenation of the Blood in Fish and Man	146
58.	Embryos of Shark, Bird and Man at the Stage when the Gill Clefts are formed	146
59.	Arterial Arches of Reptile, Bird and Mammal	147
60.	Venous System of Vertebrates	150
61.	Microscopic Section of the Thyroid Gland	153
62.	Four Embryos of Frog showing Excavitation of Primitive Gut	156
63.	Posterior, Anterior and Dorsal Aspect of the Frog Embryo at the Stage when the Neural Groove is closing up	157
64.	Transverse and Longitudinal Views of Frog Embryo shortly before hatching	158
65.	Early Stages in the Development of the Egg of the Domestic Fowl	159
66.	Formation of the Fœtal Membranes of the Chick	160
67.	Three Stages in the Development of the Mammal	161
68.	Human Fœtus in the Uterus about Two Months after Conception	163
69.	Effect of Temperature on the Development of the Frog Tadpole	165

FIG.		PAGE
70.	One-eyed Tadpole	166
71.	Metamorphosis of Axolotl Larva by Treatment with Thyroid	168
72.	Cell Division by Mitosis	176
73.	Reduction Division in Male of a Species with Four similar Chromosomes	178
74.	Reduction Division in the Female of a Species with Four Similar Chromosomes	179
75.	Microphotograph of a Dividing Cell showing Four U-shaped Chromosomes	180
76.	Chromosomes of the Stone-fly	181
77.	Chromosomes of the Plant Bug Protenor	182
78.	Chromosomes of the Plant Bug Euchistus	183
79.	Male and Female of Drosophila and their Chromosomes	183
80.	The First Studbook in History	187
81.	Mendel's Hypothesis	199
82.	Independent Assortment of Two Pairs of Factors	201
83A.	Representation of the First Generation of a Cross between Red-eyed Drosophila and the Purple-eyed Mutant	202
83B.	Continuation of Fig. 83A	203
84.	Cross between the "Ebony" and "Vestigial" Mutants of Drosophila	207
85.	Continuation of Fig. 84	208
86.	Four Different Types of Comb in the Domestic Fowl	209
87.	Sex-linked Inheritance in Drosophila	211
88.	Continuation of Fig. 87	213
89.	Crossing over between two Sex-linked Mutant Factors	218
90.	Diagram to explain crossing over between Two Loci on a Chromosome	219
91.	Linkage in a Non-sex-linked Cross	221
92.	Crossing over in the Black-vestigial Cross	223
93.	Linear Arrangement of the Genes	224
94.	Map of Some of the Mutant Genes of Drosophila	226

FIG.		PAGE
95.	Normal Frequency Curve illustrated by Variability in Weight of Beans	231
96.	Curves to illustrate Maximum Variability in the Second Generation	233
97.	Figure of the Barnacle and Goose in Gerard's <i>Herball</i> (1594)	249
98.	Shells of Radiolaria and Foraminifera	253
99.	Types of Micro-organisms	255
100.	Vertebrate Wings	267
101.	The Duck-billed Platypus	268
102.	Anatomy of the Crayfish, etc.	272
103.	The Cape Scorpion (<i>Uroplectes insignis</i>)	275
104.	The Anatomy of the Cockroach	276
105.	The Anatomy of the Cockroach (<i>continued</i>)	277
106.	Cyclops and Daphnia, Two Water Fleas, Members of the Class Crustacea	279
107.	Trilobite	281
108.	Diagrammatic Representation of an Ideal Arthropod	283
109.	The Barnacle	288
110.	Diagrammatic Representation of an Ideal Polychæte	294
111.	<i>Peripatus capensis</i>	295
112.	Chiton	301
113.	Generalized View of the Molluscan Visceral Constellation	302
114.	Unity of Type in Mollusca	303
115.	Hypothetical Common Ancestor of Cephalopods and Gastropods and Structure of a Modern Gastropod	304
116.	Cephalopod	305
117.	Ciliated Larvae of Molluscs—Trochophore and Veliger	307
118.	Diagrammatic Representation of an Ideal Echinoderm	311
119.	Hydra; A Fresh-water Polyp	313
120.	Diagrammatic Representation of an Ideal Flat worm	319
121.	Diagrammatic Representation of a Polyzoan and a Rotifer	323

FIG.		PAGE
122.	Amphioxus	326
123.	Amphioxus—Transverse Section through Gill Region	327
124.	Tunicata	329
125.	The Remains of a Giant Salamander unearthed in 1726	332
126.	The Succession of Vertebrates	333
127.	Remains of Archæopteryx preserved in Shale from Solenhoven, Bavaria	335
128.	Trilobite	336
129.	Tail Vertebræ of the Ganoid Fish (<i>Amia</i>)	338
130.	Vertebræ of an Elasmobranch (<i>Acanthias</i>)	339
131.	Trunk Vertebra of a Stegocaphalian	340
132.	Fins of Selachians	343
133.	Relation of Fins to the Pentadactyl Limb	345
134.	The Pentadactyl Limb and its Girdle	347
135.	Shoulder Girdle of a Monotreme and Typical Mammal	348
136.	Limb Skeleton of a Bird	349
137.	Digits of Fore Limb of Archæopteryx, Chick and Fowl	350
138.	Cartilaginous Skulls of Dogfish and the Frog Tadpole	352
139.	The Chondrial Bones of the Mammalian Skull	353
140.	Heads of Two Fossil Fishes from Devonian Rocks— <i>Osteolepis</i> , <i>Dipterus</i>	354
141.	The Skull of a Primitive Amphibian (<i>Stegocephalian</i>) or Reptile (<i>Cotylosaur</i>)	355
142.	The Compound Lower Jaw of a Reptile	356
143.	Comparison of Skulls of Reptiles and Mammal	357
144.	Palatal and Upper Jawbones of <i>Stegocephalian</i> and <i>Therapsid</i> Reptile	358
145.	Head of Human Foetus	359
146.	Skulls of <i>Rhynchocephalian</i> , <i>Dinosaur</i> , and Modern Bird	361
147.	Evolution of the Jaw Suspension of Mammals	363
APPENDIX II.	Biting Mouthparts	397
	Licking Mouthparts, Sucking Mouthparts	398
	Piercing Sucking Mouthparts	399
CHART.	Habitat, Habit, and Sexual Reproduction	

PART I

THE VERTEBRATE BODY AS A
GOING CONCERN

CHAPTER I

LIVING MATTER AND REPRODUCTION

WE can classify the things of which we have any knowledge in two groups as *living* and *non-living* matter. A piece of chalk or a motor bicycle are examples of non-living matter. A frog or a university professor are examples of what is called living matter. Biology is the study of things which belong to the latter class. It is sometimes defined as the science of Life. This is misleading. Science is not the study of abstract nouns. The practice of dealing with facts instead of playing with words is what distinguishes science from metaphysics.

Biologists do not use the word *living* in the same sense as lawyers or metaphysicians. When the heart of a frog has been removed, it is legally dead. In the laboratory it will continue to beat for some weeks, if perfused with a suitable fluid at the right temperature (Fig. 1). Biologists continue to speak of it as a living heart, because it still continues to show the characteristics of a heart in the living animal. The characteristics which distinguish living matter from non-living matter are not easy to put in legal language.

If we take a piece of chalk as an example of dead matter, no elaborate experiment is necessary to show that it does not display any discernible changes in shape or colour or texture over long periods of time. Unless it is subjected to great heat, the application of chemical reagents, or mechanical pressure, it does not increase in bulk or give rise to new pieces of chalk if left to itself. An animal is different. It is constantly changing in shape, position, colour, texture, etc. In short, it has greater

reactivity. An animal is influenced by innumerable events to which the piece of chalk remains comparatively indifferent—light and darkness, warmth, gentle pressure, drought, mild

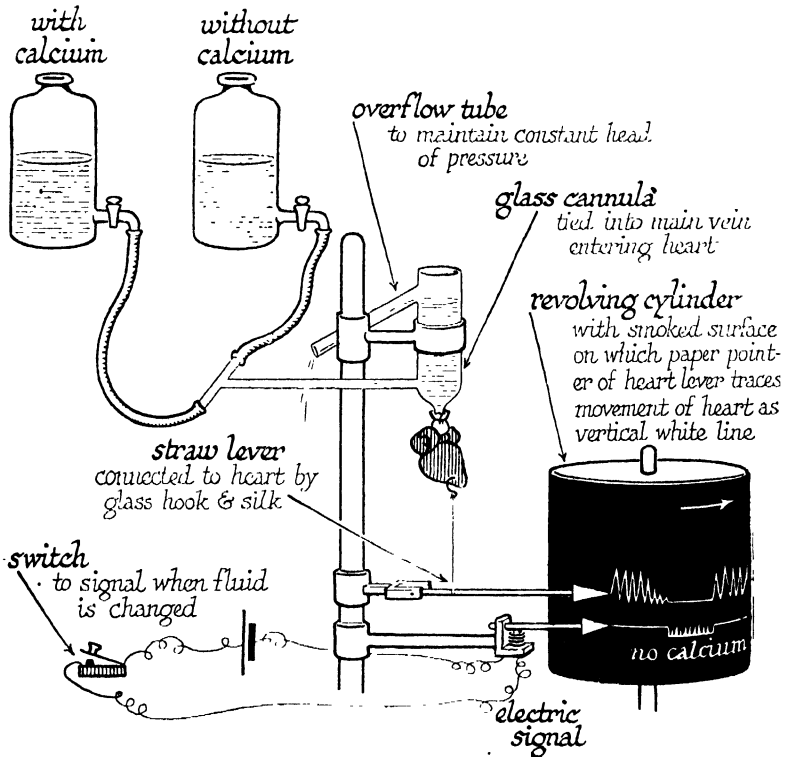

FIG. 1—SET-UP OF EXPERIMENT TO SHOW THE DEPENDENCE OF THE HEART-BEAT ON METALLIC IONS

A frog's heart will continue to beat for many hours if supplied with a solution containing the same metallic ions (sodium, potassium, calcium, and magnesium) as blood in the same proportions. By means of the taps A and B the heart can be alternately perfused with a saline mixture of the proper composition and a saline mixture from which one constituent has been left out or added in excess. The figure shows how the heart-beat stops when the heart is perfused with a calcium free fluid, and how it starts to beat normally when the proper saline is supplied once more. A sheep's heart can also be kept beating in the same way, but the fluid must be kept about body temperature.

electrical stimuli. More briefly, it has greater *receptivity*. Then again, living animals grow and produce other animals like themselves. They have the power of *reproduction*.

I. REACTIVITY

Reactivity is the most characteristic feature of the kind of living matter which we call *animals*. Artificial machines may have great capacity for effecting changes and very powerful activity which a piece of chalk does not display. But, in general, animals show a greater variety of response than the machines which we call inanimate. The difference is one of degree rather than of kind.

When we study the reactions of an animal we find that they are confined for the most part to some definite portion of it. They are *localized*. Different organs carry out different types of reaction—movement, emission of fluids, light production, etc. Below is a list of some characteristic reactions of animals and the organs which carry out these reactions. Such organs as the muscles and glands which carry out characteristic changes of behaviour are called collectively *Effector organs*. These organs will be studied in detail later, when the terms will be explained.

TYPE OF RESPONSE	EFFECTOR ORGAN
<i>Movement</i>	
(a) limb, etc.	Striped
(b) gut (peristalsis)	Plain
uterus (parturition)	
bladder (micturition)	
(c) heart beat	Cardiac
	} <i>Muscle</i>
<i>Fluid Motion</i>	
Roof of frog's mouth	<i>Ciliated Epithelium</i>
Gills of clam, etc.	

TYPE OF RESPONSE	EFFECTOR ORGAN
<i>Secretion</i>	
Flow of saliva	<i>Glands</i>
Sweating	
Venoms, etc.	
<i>Colour Change</i>	
Chameleon's skin, etc.	<i>Pigmentary Effectors</i> (Chromatophores)
Retinal pigment cells of Man	
<i>Bioluminescence</i>	
Firefly	<i>Photogenic Organs</i>
Glow-worm	

II. RECEPTIVITY

When an animal responds in any of the characteristic ways which have been enumerated above, careful observation usually reveals that the response is related to some definite happening in its surroundings, to some physical event in the external world. The reader perhaps yawns once more as he reads this. The yawn (if it occurs) is definitely related to the words he is reading. In similar circumstances he (or she) would not yawn if the written matter announced a legacy of \$5,000 to himself or herself.

As a more manageable illustration of the dependence of an animal's behaviour on its immediate surroundings we may take the power of colour change in the chameleon or the frog. Like the chameleon the frog exhibits changes of hue, but they are not so rapid. Indeed, they require periods of several hours rather than minutes to reach completion, though they are just as striking. Colour response in the frog is influenced by three principal external influences—light, moisture, and temperature. If the field of vision is occupied by a light-scattering surface ("white background") the animal will be paler than if the field of vision is occupied

by a light-absorbing surface ("black background"). If kept dry the animal will be paler than if it is kept in water; and at 20° C. it will be paler than at 5° C., other factors being constant. So the optimum conditions for pallor are white background, dryness, and warmth. For darkening of the skin, black background, moisture, and cold are best.

The chameleon, like the frog, responds to light and temperature, and it will become completely pale after suitable electrical or mechanical stimulation. A toy shocking-coil serves well for the former purpose. If we apply these stimuli to different regions of the body, we find that the same stimulus does not everywhere call forth the same colour changes. If the skin of the surface of the body, roof of the mouth, and excretory orifice (cloaca) are respectively stimulated by a series of electric shocks, or by hard rubbing with a glass rod, the results obtained may be tabulated thus:

COLOUR CHANGE IN THE CHAMELEON

<i>Stimulus</i>	<i>Area</i>	<i>Response</i>
Electrical	Skin of surface	Local pallor
	Roof of mouth	Generalized pallor
	Cloaca	Generalized pallor
Mechanical	Skin of surface	No effect
	Roof of mouth	No effect
	Cloaca	Generalized pallor

Light acts on any portion of the skin of the chameleon, making dark (not pale) the area on which the light falls. The direct action of light on the skin of the frog is too small to detect with the naked eye. The same is true of fishes, many of which respond in a very striking manner to light and darkness. Blinded or blindfolded fish do not respond like fish in which the eye is perfectly intact and accessible to the light. Fish respond to *background* only, when the eyes are intact. This is also true of the frog, but because

colour response in the common frog is influenced powerfully by temperature and moisture, the part played by the eyes can be better illustrated in one of its near cousins, the South African clawed toad (*Xenopus laevis*) which lives in water and from this standpoint is much less susceptible to the influence of temperature. When the skin colour of clawed toads is compared under different conditions of illumination, the contrast of normal and eyeless or blindfolded individuals is indicated in the following table:

COLOUR CHANGE IN *XENOPUS LAEVIS*

	<i>White background</i>	<i>Black background</i>
Normal animal	Very pale	Very dark
Eyeless animal	Intermediate	Intermediate

We see from this that just as different portions of the body, the effector organs (muscles, glands, the "pigment cells" which are responsible for colour changes like the above, etc.), are specially concerned with carrying out responses, so special parts of the body (*receptor organs*) are specially affected by such happenings in the animal's surroundings as call forth response of one kind or another.

In contemporary biological nomenclature the term *receptor organ* replaces the older one *sense organ*. It is greatly to be preferred, because it involves no departure from our initial resolve to treat the animal as a tangible object in the world around us. For the same reason the term *purpose* should never be used in biology. An *organ* fulfils a certain *rôle* in the economy of the organism. Whether it discharges a purpose we cannot know by any methods whose validity has been vindicated so far. Thus the eye is the main receptor organ through which light influences the behaviour of an animal. The ear of our bodies is the organ by which sound vibrations exercise an effect upon us. The ear is a complex organ, and

is also the structure by which gravity operates on our behaviour. Some important receptor organs which will be dealt with in a later chapter are given in the list following:

TYPE OF STIMULUS	RECEPTOR ORGAN
<i>Light</i>	<i>Retina</i>
<i>Sound</i>	<i>Cochlea of Ear</i>
<i>Gravity</i> (mechanical displacement)	<i>Labyrinth of Ear</i>
<i>Chemical</i>	
(a) Gaseous	<i>Olfactory Membrane</i>
(b) Dissolved	<i>Gustatory Membrane</i>
<i>Deep Mechanical Pressure</i>	<i>End Organs in Muscles</i>
<i>Temperature</i>	<i>End Organs in Skin</i>
<i>Generalized Superficial Pressure</i>	<i>Tactile Bulbs in Skin</i>

The power of receptivity is not peculiar to animals in any absolute sense. We can make machines which will respond to any type of stimulus. A device which responds to light by movement is seen in the windows of any large optician. Animals are peculiar in so far as they excel in receptivity even the most complicated of the machines which man has so far devised.

III. REPRODUCTION

Reproduction is not a property possessed by all living matter. Nor even by all the units of living matter which we call individuals, as met with in nature. The worker bee does not reproduce its kind, but the worker bee could not have existed if there had been no other bees. Every piece of living matter we know has been manufactured by some other piece of living matter very much like itself. The Ford car, like the frog, has a movable body; but we do not see little Ford cars disporting on the grass before the garage. Most artificial machines are made to-day by the activity of other artificial machines; but the machines which co-operate

to make a Ford car are not themselves Ford cars or very much like Ford cars. With animals it is a universal rule that *like begets like*. This now commonplace statement has only been known to be true of all animals for about a hundred and fifty years. The history of our knowledge of the reproductive process in animals will be set forth later.*

Animals produce other animals in two different ways. One way is called asexual or vegetative, and the other, which requires the co-operation of two animals, respectively called the male and female, is called sexual reproduction. The first is a much simpler method, less unlike processes which we can imitate artificially. It is the only method of reproduction which occurs among large numbers of minute organisms which are simpler in their organization than any of the things we ordinarily call animals or plants. Such are the germs of disease and putrefaction (bacteria). Asexual or vegetative reproduction does not occur among the more complex animals like frogs or ourselves.

Asexual or Vegetative† Reproduction.—As an illustration of the latter, therefore, we shall have to study one such small organism that can often be found in mud. If samples of mud from several ponds are added to a little pond water in which a few bread crumbs have been allowed to soak, after standing for about a day or two the mud at the bottom when examined under the microscope is found to contain little rapidly moving creatures, denoted by the technical name, *Paramœcium*. Each is of a cigar shape, and if you can observe one when it is not moving too quickly you will see that its movements are due to fine flickering processes called *cilia* (because of their

* Chapter IX.

† The word *asexual* is applied to reproduction of plants by *unicellular* (*vide infra*) spores. When animals produce offspring by splitting or budding as does the green Hydra (p. 313) the word *vegetative* is more appropriate.

resemblance to eyelashes—the Latin word). These cover the whole body. Somewhat similar organisms (Opalina, Balantidium, etc.) can always be found living parasitically in the muddy contents of the hindermost portion of the bowel of the frog. When such organisms as these have gone on feeding for a certain time, they become constricted about the middle, and gradually divide into two, just as a drop of a fluid will divide into separate drops when it has reached a certain size

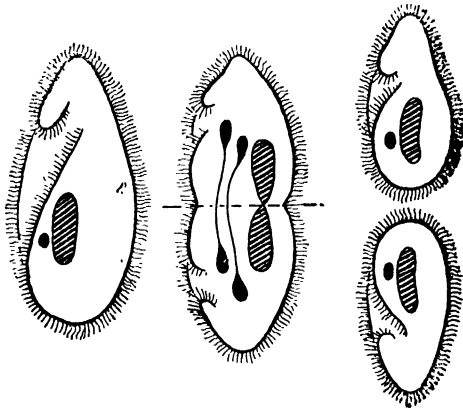

FIG. 2—*Paramecium* dividing

(Fig. 2). Each half becomes a new individual and swims off on its own. Thus every *Paramecium* arises from another *Paramecium*.

Like begets like is a rule that applies equally to *Paramecium*, the common frog, and ourselves. But in all those organisms which are properly called animals in every-day language each sort or *species* has two kinds of individual, males and females; and reproduction involves the co-operation of a male and a female. Both are equally essential to the production of a new being, though the precise part which the male plays in the process was not clearly understood till about fifty years ago.

Sexual Reproduction.—The female frog is externally different from the male. It is somewhat larger and its forelimb has no horny thumb-pad. At the breeding season, in Spring, frogs may be found in ponds and streams in pairs. A male tightly clasps a female about the body with its forelimbs, his ventral surface in contact with her back. Thus they

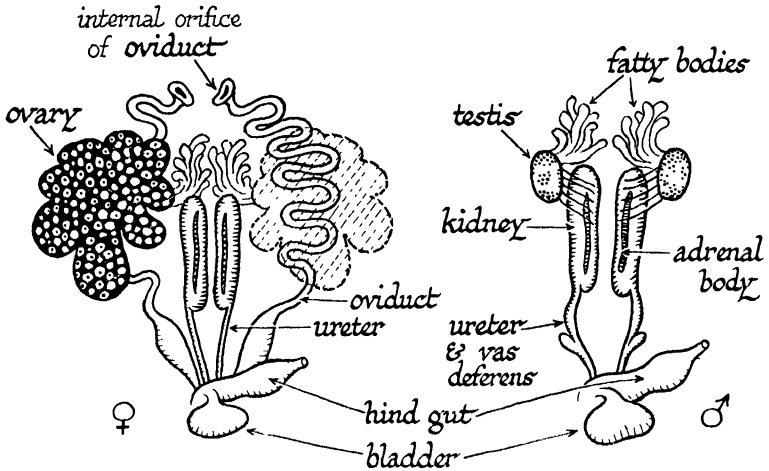

FIG. 3.—REPRODUCTIVE AND ASSOCIATED ORGANS OF THE FROG

remain, till the eggs are shed in great numbers embedded in masses of clear jelly, which may be seen floating on the surface of the water. Each egg is almost completely spherical, black in colour towards the pole which floats uppermost, but lighter beneath. As the eggs are laid the male squirts a viscid stream, the seminal fluid, over the surface of the egg.

If the seminal fluid is examined with a microscope, as was first done by a Dutch draper, Leeuwenhoek, in 1668, it is seen to swarm with myriads of minute moving objects, called *spermatozoa*, or more shortly *sperms*. With a very high magnification each sperm is seen to be somewhat like a tadpole in shape. It has a short thick body with a thin whip-like

tail or cilium. The sperm dashes hither and thither by its lashing movements. If the male is taken away from the female before the eggs are laid, and the latter removed from the body of the mother, the eggs will not develop into tadpoles. But if these eggs are placed in a bowl of water to which some

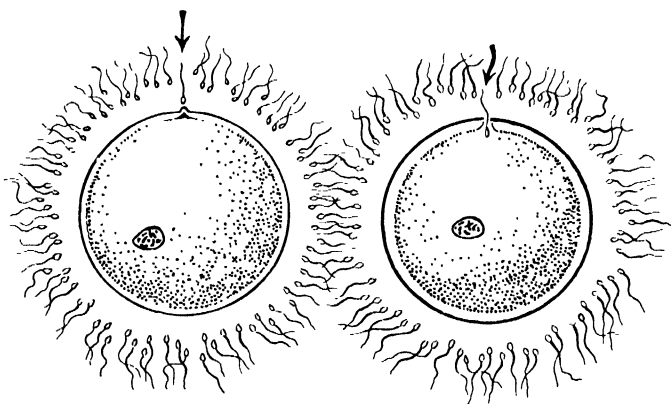

FIG. 4—FERTILIZATION IN THE STARFISH

Each egg is surrounded by sperms attracted to it by a substance which it gives off into the water. On the left one sperm is approaching the egg which sends out a cone of protoplasm to receive it. On the right, a sperm has entered and a thin membrane is separating from the surface of the egg, keeping the other sperms out.

seminal fluid obtained from a male was added immediately before, they become capable of developing. Seminal fluid from which the sperm has been filtered off through several layers of blotting paper does not possess this fertilizing power. In 1879 two German investigators, Hertwig and Fol, first observed the fertilization of the sea urchin's egg under the microscope. They were able to see that one sperm, and one only, bores its way into the egg of a sea urchin, as the preliminary to its development into a new organism. We now know this to be true of all animals that reproduce sexually. Development of the egg starts when one of the innumerable minute sperms contained in the semi-

nal fluid ejaculated by the male penetrates into the substance of the egg. *Fertilization*, the process by which the egg starts to develop into a new creature, is, in all animals, the union of one sperm with one egg. So what we now mean by inheritance from the father is the material substance of the sperm;

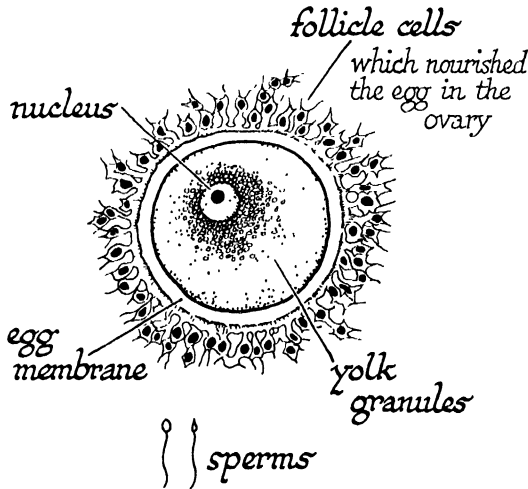

FIG. 5—HUMAN EGG AND SPERM

The actual size of the egg is less than .2 mm., and the sperms (below) are drawn to the same scale. The thickened head of the sperm (seen here in two views) contains the nucleus.

and what we now mean by inheritance from the mother is due to the material of which the egg is composed.

As we use these terms in modern biology an animal that produces eggs is a *female*. An animal that produces sperm is a *male*. The eggs are produced in masses, which are called *ovaries*, within the body of the female. The sperm are produced in a slimy secretion, the seminal fluid, by organs known as *testes*. Collectively ovaries and testes are referred to as *gonads*. In the female frog the ovaries occupy a large part

of the body cavity in the trunk region. They are masses of eggs in different stages of growth. Two coiled white tubes (*oviducts*) on either side convey them to the exterior at the breeding season. With the excretory orifices the oviducts discharge into a short tube, the cloaca, between the legs. In the male there are two yellow or white bodies of ellipsoidal shape—the testes—lying over the kidneys and communi-

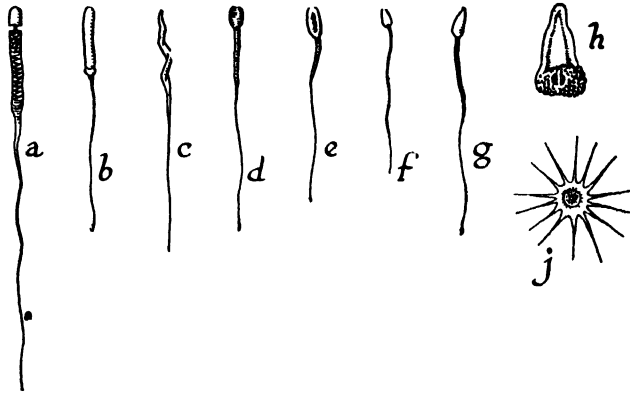

FIG. 6—SPERMATOZOA OF DIFFERENT ANIMALS

(a) Bat, (b) Frog, (c) Bird (finch), (d) Sheep, (e) Pig, (f) Jelly fish, (g) Monkey.

The Spermatozoa of threadworms (h) and of crabs and lobsters (j) are unlike those of all other animals.

cating with the exterior by the same duct or passage which conveys the urine to the common excretory orifice (Fig. 3). At the breeding season, when the eggs in the ovaries are ripe, they can be fertilized after removal from the body. If kept in clean water they will not develop, unless we add to it a drop of seminal fluid, which can be prepared by crushing up the testes of a male in tap water.

The female frog lays her eggs embedded in masses of a clear jelly, analogous to the albumen of the fowl's egg, and,

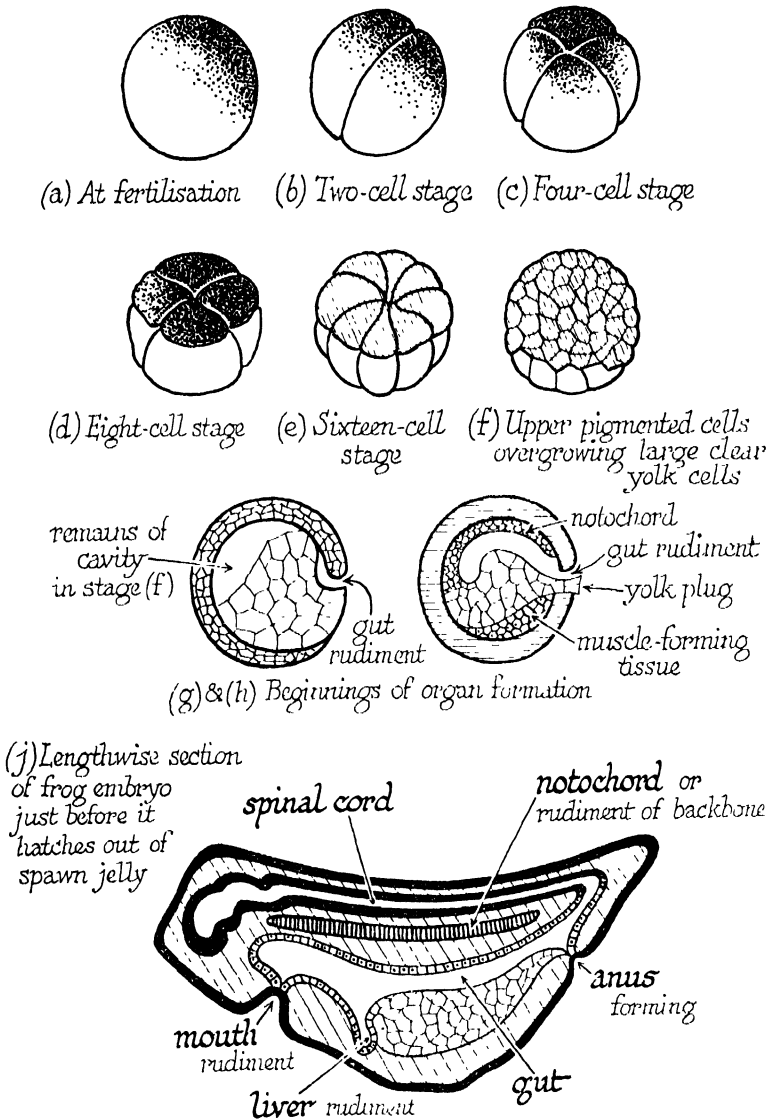

FIG. 7—STAGES IN THE DEVELOPMENT OF THE FROG'S EGG

like it, secreted by the wall of the oviduct. They have no shell. So we can study what follows fertilization more easily

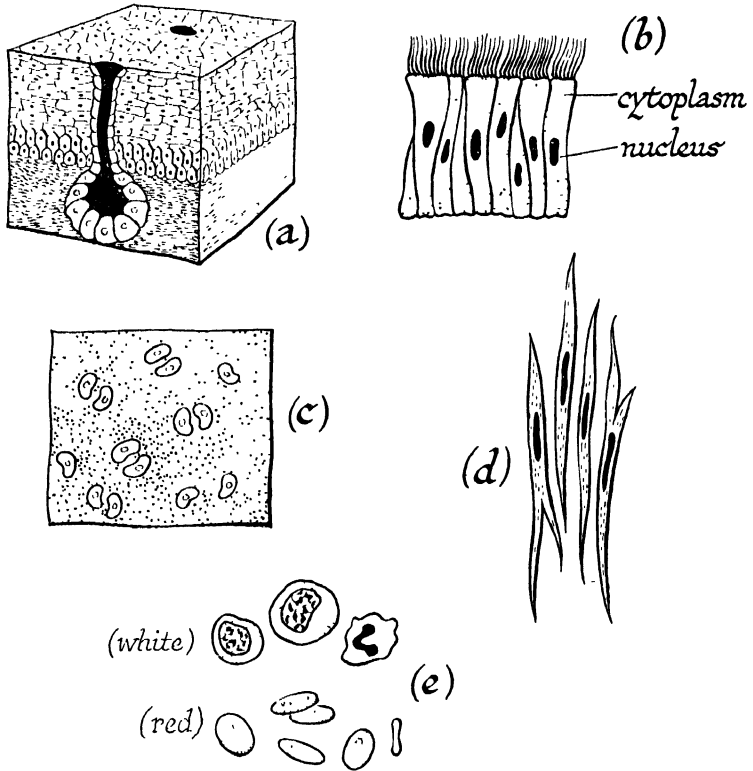

FIG. 8—CELLULAR STRUCTURE OF THE ANIMAL BODY

- (a) Cube cut from the skin of the frog shewing successive layers of cells which make up the outer skin or epidermis, and a simple pit-like gland whose slimy secretion keeps the surface moist.
- (b) Lining membrane of the human windpipe; the cells have fine vibratile outgrowths called *cilia*, whose swaying motion keeps the moist film of phlegm circulating.
- (c) Cartilage from shoulder blade of frog, shewing cells lying in a gelatinous matrix which they secrete.
- (d) Teased out muscle fibres from the human bladder. Each contractile fibre is a single elongated cell.
- (e) Three kinds of white blood cells and a group of red blood corpuscles from man.

in the frog than in an animal whose eggs are protected by an opaque envelope or develop to a late stage in the body of the mother. Once the sperm has made its way into the egg a change occurs in its outermost layer. No other sperm can now penetrate it. Soon after a furrow appears on the surface of the egg, which divides into two in much the same way as a *Paramœcium* divides in asexual reproduction. But the two halves, which are called *cells*, do not separate, like two newly formed *Paramœcia*, to start separate lives of their own. They remain connected and divide again. The process is repeated again and again. Within twenty-four hours after fertilization, the egg can be distinctly seen with a simple lens as a hollow ball of many such cells. Thenceforth changes take place in the rate of multiplication of the cells in different regions. From different groups of cells the characteristic structures or *organs* of the body begin to take shape. Cells are the microscopic bricks from which the whole edifice of the body is built up (Figs. 7 and 8).

The Cellular Structure of the living body.—The cells of the frog *embryo* are very much alike at first. Each resembles a very small egg from the ovary. The cells of different parts of the body of a tadpole or of an adult frog are not all alike. In different regions they have different shapes and sizes. What is common to all of them is that they possess a structure called the *nucleus*. This essential part of every cell is recognized partly by the fact that it takes up certain dyes and partly by the peculiar changes which it undergoes during cell division. These will be described later (p. 177). The ovaries of a tadpole are simply masses of more or less spherical cells with large spherical nuclei. Each of these cells enlarges as it deposits fatty storage material for the use of the embryo, and eventually becomes one of the ripe eggs in the ovary of an adult. The

nucleus of the fully formed egg in the adult ovary is inconspicuous, but if we tease away the ripe ova and examine the intervening tissue we can see under the microscope that it is

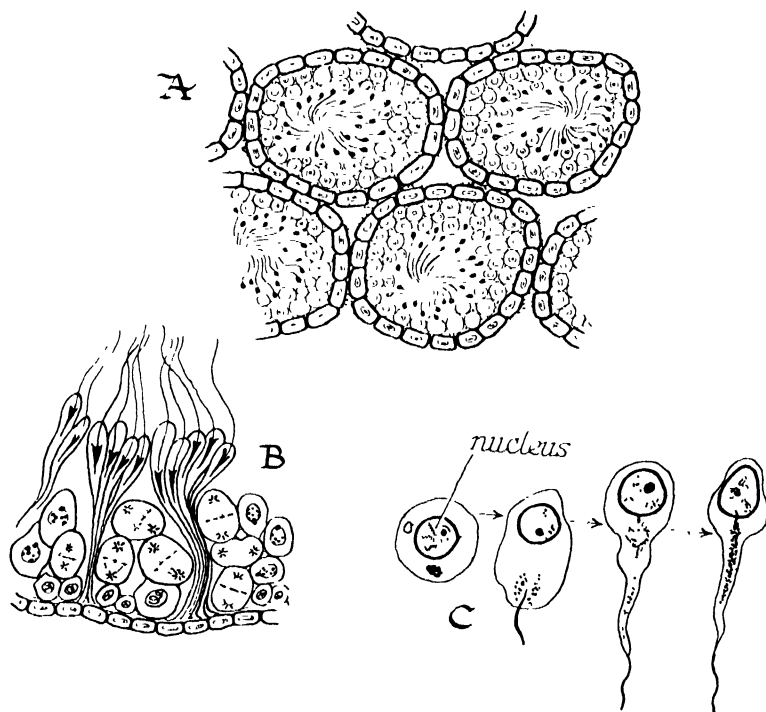

FIG. 9—THE CELLULAR STRUCTURE OF THE TESTIS

- (A) Low-power microscopic view of the testis of a Rat.
 (B) Diagrammatic view of part of the wall of a single tubule.
 (C) Stages in formation of a sperm from a single cell (spermatocyte) of the tubule.

made up of small eggs with clear prominent nuclei like the immature eggs in the ovary of a tadpole. These will grow to become ripe eggs at the next breeding season. The testis is a mass of tubules connected with its duct. The wall of each tubule is made up of several layers of cells. Those of the

outermost layer are rather like the immature eggs in the ovary of a young tadpole. They undergo repeated division to replace the innermost layers from which the sperms are shed. Each sperm is formed from a single cell of the innermost layer. The bulk of the body of the sperm is its nucleus. The rest of the cell body is drawn out to form the tail.

The parts of the body of an adult animal may be classified as *organs* according to the sort of work they do, and as *tissues* according to their texture or visible appearance. A single organ may be mainly made up of one sort of tissue, or it may be a combination of many. Each tissue has its characteristic microscopic structure. Like the testis or ovary, the substance of all the organs of the animal body is also built up of microscopic bricks called cells (Fig. 8). In some tissues like bone and cartilage the bricks are separated by a good deal of plaster, or to use the technical term, *matrix*. Others, such as the *epithelia* or lining membranes of all surfaces, internal or external, including the tubular cavities of the glands, consist simply of cells packed closely together. Although the cells of different tissues acquire different shapes and sizes as the development of the frog's egg proceeds, they all arise by division of the undifferentiated cells in the hollow ball stage. The process of cell division involves the partition of the nucleus in the same characteristic manner, described under the term *mitosis* (*vide infra*). Its detailed features were not described till high-power microscopes began to be used.

The distinction between tissues and organs in the preceding paragraph runs parallel to the way in which the two terms, *homology* and *analogy*, are commonly used by biologists. Structures are said to be *analogous* when they do the same work. In contradistinction to functional similarity or analogy, homology is structural resemblance. Organs are said to be

homologous when they are built up in the same way or have the same structural relation to adjacent and corresponding

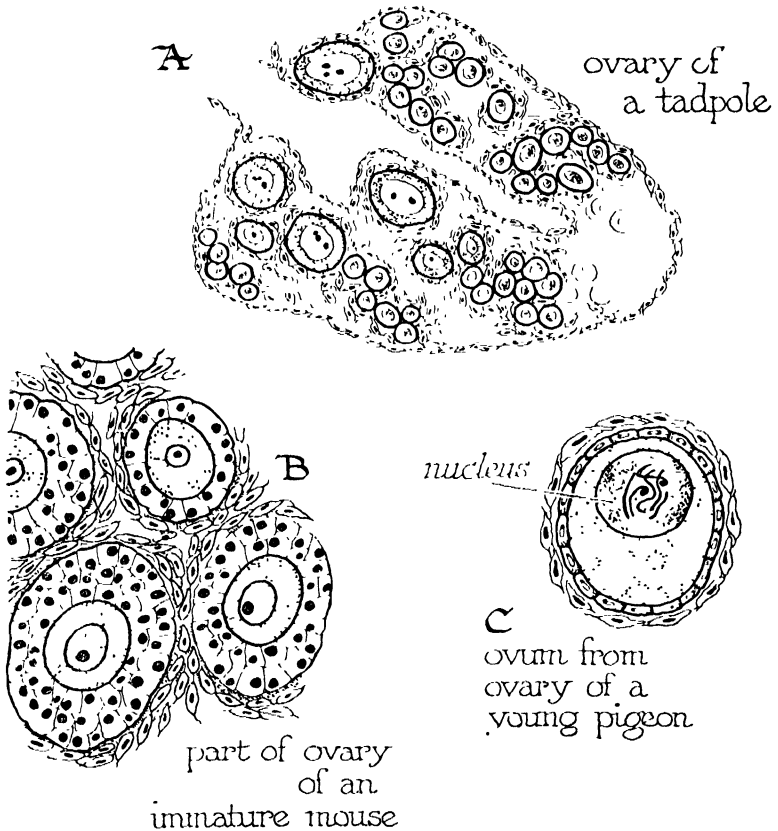

FIG. 10—IMMATURE OVA OF DIFFERENT VERTEBRATE TYPES

Note that relatively few cells of the mammalian ovary eventually become ripe ova. These grow at the expense of others which form spherical capsules, called Graafian follicles, around them.

parts. Homologous structures of the adult may be recognized as such because they develop from corresponding parts of the embryo, even if their resemblance is not apparent when

animals are full grown. The homology of organs may also be recognized, because of their common structural resemblance to an intermediate type.

General Characteristics of Sexual Reproduction.—Certain features of sexual reproduction are common to nearly all animals. Others are characteristic of particular types. A comparison between the reproductive processes of the fowl and the frog draws attention to some of the latter. In birds the two sexes are recognizable by secondary sexual differences analogous to those of the frog. For instance, the spurs, neck hackles, tail sickles, and comb distinguish the male White Leghorn from the hen. The cock has two testes which look like those of a frog, and have a similar microscopic structure. The seminal fluid produced by them contains spermatozoa of the same general appearance and dimensions. It is not squirted over the eggs as they are laid, but is introduced into the oviduct of the female, when the excretory orifice of the male is closely applied to that of the female during the act of *coitus* or copulation. The immature eggs in the ovary of a newly born chick are much like the immature eggs of a frog, and like them have large, clear, spherical nuclei. At sexual maturity they grow till they attain the size of what we call the *yolk* of an egg. They are then liberated into the oviduct. After the yolk or ovum *sensu stricto* has been fertilized, it acquires an albuminous coat comparable to the mucilaginous jelly around the egg of the frog. In the lower part of the oviduct other envelopes are secreted around it, first the shell membrane and then the calcareous shell itself. After the sperm nucleus has united with the egg nucleus, which lies in the clear circular area on the side of the yolk of an infertile fowl's egg, the combined nucleus divides in the usual way, but only a small part of the fowl's yolk is

partitioned off round each cell. Division (*segmentation*) of the ovum is *incomplete*. The embryo is at first a small plate of cells lying on the surface of the remaining yolk and growing at its expense (Fig. 11). The domestic fowl lays eggs at definite intervals—in high-laying strains like the White Leghorn about twenty-six hours. The eggs are deposited whether they are fertilized or not.

The salient similarities and differences may be summarized thus:

	Frog	Fowl
1.	A new individual is produced as the result of the union of a motile cell (sperm) of microscopic dimensions contained in the seminal fluid of the male, with an immobile cell (ovum).	
2.	The immature ova are spherical cells with large clear spherical nuclei.	
3.	The sexes are separate, i.e. an individual produces either sperms or ova but not both.	
4.	The sexes associate before fertilization normally occurs.	
5.	The sexes are externally distinguishable by their appearance.	
6.	The egg has no shell.	The egg has a calcareous shell.
7.	Fertilization is <i>external</i> .	Fertilization is <i>internal</i> .
8.	Though visible the egg is small compared with the body as a whole.	The egg is larger than the head of the adult animal.
9.	<i>Segmentation</i> is <i>complete</i> .	<i>Segmentation</i> is <i>incomplete</i> .
10.	An independent <i>aquatic</i> existence begins before the characteristic features of the adult are recognizable.	An independent <i>terrestrial</i> existence begins when the general characteristics of the adult are recognizable.

Our table brings out five similarities and five differences. Of the similarities the first two are based on microscopic examination and are shared by the overwhelming majority

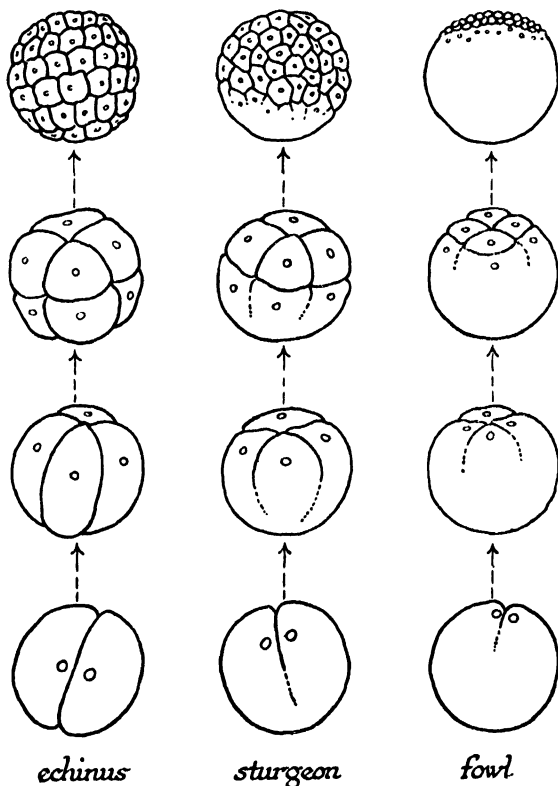

FIG. 11.—FIRST CLEAVAGE DIVISIONS

(Relative size of Fowl's cleavage furrows and blastoderm exaggerated owing to space limits, cf. Fig. 65).

of animals. There are very many *hermaphrodite* species to which the third does not apply. Animals are said to be hermaphrodite if testes and ovaries are present in one and the same individual. Hermaphrodite species include most sedentary animals (*polyps*, *barnacles*, *sea mats*, *sea squirts*), a

high proportion of parasitic animals, and many familiar types such as snails and slugs, earth-worms and leeches, which are neither sedentary nor completely parasitic. Many clams and some other animals are *consecutively* hermaphrodite, i.e. male at one stage in their lives and female at another. The male of the common toad has a small ovary called Bidder's organ attached to each testis. Occasionally ripe eggs develop from it.

The fourth and fifth similarities apply only to a minority

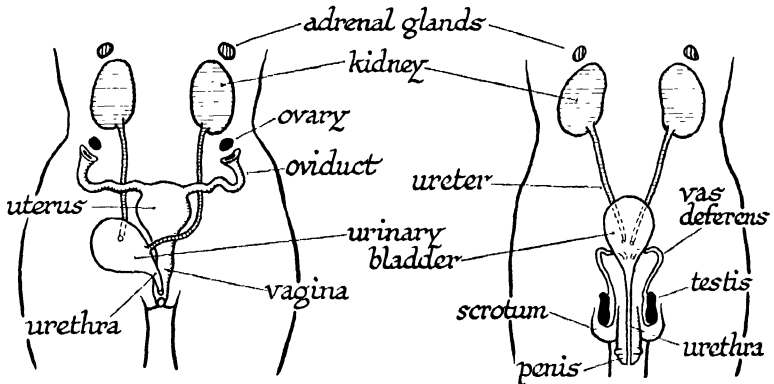

FIG. 12—GENITAL ORGANS OF MAN WITH ASSOCIATED STRUCTURES

On the left, female (♀); on the right, male (♂).

of *marine* animals. Most typically marine animals shed their seminal fluid or ova in the sea at spawning time without any association of the sexes. When the sexes are separate males and females have no distinguishing external differences and the gonads themselves may be difficult to distinguish without recourse to microscopic examination. Association of the sexes is characteristic of all animals which are terrestrial or live in shallow fresh waters. In all terrestrial groups fertilization is internal, and males of many terrestrial animals have a special organ, the *penis* (Fig. 12), which is

inserted into the female orifice during coitus. There is one striking exception to the general rule that fertilization is always *internal* among land animals. Oligochætes (earth-worms) are hermaphrodite and copulate reciprocally. In copulation seminal fluid from the male genital orifice of each worm is introduced into special sacs (spermathecæ) of the other. From the spermathecæ it is subsequently extruded over the eggs which are liberated from the neighbouring genital orifice.

Evolution of Sex.—There are therefore differences of sexual reproduction associated with the habit and habitat of animals as the last item of our Table suggests. Such differences are summarized in the next Table. The animals placed in the larger (*phyla*) and smaller (*classes*) groups referred to in this Table will be found in the Addendum to this chapter on p. 43.

The record of life in the rocks tells us that life began in the sea. The features of sexual reproduction associated with habitat and habit as displayed in the accompanying Table therefore suggest that all animals alive at one time reproduced as sea urchins, starfishes, and bristle worms reproduce to-day. The sexes were not externally different and did not associate. They shed innumerable sperm or innumerable minute *naked* eggs into the surrounding water, where fertilization occurred without sexual union of the parents themselves. The naked embryos quickly embarked on a free living aquatic existence, and required no generous supply of food stored in the egg for their needs. This state of primitive innocence could not last when the exposure of great continental land shelves began. Females of littoral species could now lay their eggs in gullies where males might not be available, or on rocks left dry by the receding tide. So the survival of species

which frequented the water edge imposed two new conditions which entailed other changes. One was for some loose *association* of the sexes such as exists in the salmon to-day. The other was for some form of protection against *desiccation*, such as the water-absorbing jelly around the egg of the frog. It is possible that association of the sexes began as the result of chemical stimulation due to substances extruded at spawning time. In any case, visible differences would provide an additional safeguard. A survey of existing animal types shows that visible differences which have no connexion with the sex organs (so-called *secondary sexual characters*) only occur in animals which associate at spawning time or perform the more intimate act of *coitus*.

When the appearance of land floras made it possible for some littoral species to make their way into estuaries or creep under banks of seaweed beyond the intertidal zone, the dangers of exposure to drought were necessarily greater. The secretion of a calcareous (reptiles, birds, some whelks), horny (many molluscs), chitinous (insects), or gelatinous (snail) envelope around the egg could provide the necessary protection. The production of a *cleidoic* or shelled egg would in general presuppose a parallel development of sexual association to ensure internal fertilization before the egg was enclosed in its protective layer. An early free-living aquatic existence as a larval form had now become impossible and a more protracted embryonic existence was only possible if there were sufficient reserves of food material. The production of a smaller number of more *heavily yolked* eggs was therefore a necessary condition of the rise of a land fauna. Since eggs which contain relatively little yolk do not undergo partial cleavage, incomplete segmentation appears to be a mechanical necessity of development

when the amount of reserve material is relatively large, Fig. 11.

A few animals have carried this process of protecting the developing embryo against drought or food shortage still further. Cleavage has already begun in the oviduct of the fowl. In some reptiles (e.g. the Cape chameleon) and fishes the embryo completes its development within the oviduct. With the exception of the duck-billed *Platypus* and the spiny anteater *Echidna*, which lay eggs with chalky shells like those of a bird or a lizard, all mammals are *viviparous*, as opposed to *oviparous*. The embryo is nourished by a connexion with the blood supply of the mother in the part of the oviduct called the *uterus* or womb. Thus it has no need for a large reserve of food. The ova of mammals are minute and undergo complete cleavage. The egg of an ostrich weighs several pounds. The egg of the human female is about half the size of a full stop as printed on this page. It is liberated into the oviduct once a month, after sexual maturity has been reached (about the age of thirteen). The process occurs about half-way between a monthly renewing of the mucous membrane of the internal generative passages preceded by a slight hæmorrhage (menstruation).

Parthenogenesis.—Broadly speaking, what we mean by sexual reproduction to-day is contained in the first two items of the 'Table on page 35; and implies nothing more than that. Sexual reproduction is not absolutely universal among animals in this sense. Here and there in the animal kingdom we come across species which have dispensed with the male contribution to the process. Among *Hymenoptera* (bees, ants, wasps, gall flies) and among the freshwater wheel animalculæ (*Rotifera*) females are formed from eggs fertilized in the usual way, and males are produced from eggs which develop

without contact with the seminal fluid. Parthenogenesis or virgin birth is carried further in a few species. Most gall flies and Aphids have a regular alternation of parthenogenetic generations composed entirely of females and bisexual generations composed of both sexes. A few gall flies (e.g. *Cynips* and *Rhodites*), some stick insects, and a few freshwater fleas reproduce exclusively by virgin birth. The male of the species either does not exist in nature or, if it does, occurs with great rarity.

Thus it is not a physical impossibility for animal species to dispense with the male, and it is even conceivable that biologists may help to bring about this sex reform in the human race. The entry of the sperm is a physical event associated with material changes in the egg, and these changes are capable of being imitated. One of them is an increase of permeability to dissolved substances. Physical agents which change the semi-permeable property of the egg periphery are capable of initiating the process of cleavage without the aid of the sperm. In 1899 the brilliant American biologist, Jacques Loeb, discovered that eggs of a sea urchin placed in a mixture of sea water and magnesium chloride about twice the molar concentration of sea water, grew into free swimming larvæ. He found later that this was not due to the specific action of magnesium, since sea water made more concentrated with a variety of substances would do exactly the same. Moreover, the concentration of each substance which was most effective, in producing the greatest number of successes, was found to be such as to exert a definite *osmotic pressure*. It had to have a measurable and fixed power of withdrawing water from the egg. Subsequently Loeb found that 100 per cent fertilization could be obtained by preliminary insertion of the eggs in acidified sea water. By various methods

artificial parthenogenesis has now been carried out with a variety of species. The frog's egg will develop without the aid of the sperm if pricked with a fine glass fibre. Fatherless tadpoles have actually been raised through metamorphosis to the adult condition.

Immediately after fertilization another important change occurs in the egg. All the while it is, in popular language, "alive," that is all the while it retains its capacity for developing further, the egg can be shown by an electrical thermometer, the thermopile, to be giving off heat. It can also be shown, by chemical analysis, to be steadily taking up oxygen and giving off carbon dioxide gas. Immediately after the penetration of the sperm or artificial activation, the heat production and oxygen intake suddenly increase, sometimes a thousand-fold in a few minutes. We call this activity respiration, and have hitherto regarded it as inseparably bound up with the other properties we refer to, when we say the egg-cell is alive. We can now separate it from other characteristics of which we imply the existence when we speak of a living cell. Warburg (1912) showed that, if sea-urchin eggs are suddenly dried by plunging them in acetone, and subsequently powdered, the moistened powder can continue to take up oxygen for some time, like the egg-cell. Poisons which act by stopping respiration in the tissues of an animal, such as cyanides (prussic acid salts), affect it in just the same way. Warburg also found that the action of prussic acid was definitely related to the amount of iron in the egg cell, and that suspensions of charcoal containing traces of iron will induce fatty substances, sugars, and the products of substances like egg white to undergo slow combustion in air. These iron-containing charcoal suspensions are also affected by cyanides in the same way as living cells.

That is to say, minute traces of prussic acid salts will bring their power to facilitate oxidation of organic substances to a standstill.

More than a century ago the Abbé Spallanzani showed that when luminous jellyfishes are desiccated and ground to powder the powder will at once emit light when moistened. Nobody recognized at the time that a property hitherto associated with "living matter" had been taken over into the domain of chemistry and physics by that simple experiment. We are far from being able to manufacture a system that would be called by any ordinary person "living," but every year shows more striking advances in manufacturing systems which are similar in some respect to what we call living things.

ADDENDUM TO CHAPTER I

When comparisons are made between other animals and types studied in the earlier chapters of this book, reference may be made to the following classification which will be explained more fully in Chapters X and XI.

1. PORIFERA (sponges)
2. CŒLEENTERATA
 - (a) Hydrozoa (polyps)
 - (b) Scyphozoa (jellyfishes)
 - (c) Actinozoa (sea anemones and corals)
3. PLATYHELMINTHES (flat-worms, flukes, tape-worm)
4. NEMATHELMINTHES (thread-worms)
5. ROTIFERA (wheel animalculæ)
6. ECHINODERMATA (starfishes, sea urchins)
7. MOLLUSCOIDA
 - (a) Brachiopoda (lamp shells)
 - (b) Polyzoa (sea mats)
8. ANNELIDA
 - (a) Polychæta (marine bristle worms)
 - (b) Oligochæta (earth-worms)
 - (c) Hirudinea (leeches)

9. MOLLUSCA

- (a) Pelecypoda (oysters, mussels)
- (b) Gastropoda (limpets, whelks, snails, and slugs)
- (c) Cephalopods (cuttlefish, octopus)

10. ARTHROPODA

- (a) Crustacea (shrimps, slaters, water fleas, crabs)
- (b) Arachnida (king crabs, scorpions, spiders, ticks)
- (c) Myriapoda (millipedes, centipedes)
- (d) Insects (all winged invertebrates, fleas, lice)

11. VERTEBRATA

- (a) Pisces (fishes)
- (b) Amphibia (frogs, newts)
- (c) Reptilia (lizards, snakes, crocodiles, tortoises)
- (d) Aves (birds)
- (e) Mammalia (man, whale, bat)

TOPICS FOR HOME STUDY

1. Make a table to show the association of habit, habitat, and sexual reproductive phenomena in the following:

Jellyfish; starfish; lamprey; dogfish; whale; toad.

State what conclusions are suggested thereby. Place them in their appropriate classes by reference to the scheme on page 43.

Discuss the relation between sexual reproduction, habit and habitat.

2. What characteristics of sexual reproduction are common to most animals, and how do the characteristics of sexual reproduction vary in animals which pursue different modes of life?
3. What is meant by (a) parthenogenesis, (b) hermaphroditism. Give examples of their occurrence.
4. For students who are studying botany. Compare the influence of habitat on the evolution of sex in animals and plants. (cf. Bower's *Origin of a Land Flora*, and Church's *Thalassiophyta*).

CHAPTER II

THE MACHINERY OF RESPONSE

WE have already enumerated some of the characteristic differences between animals and non-living objects under the three headings *reactivity*, *receptivity*, and *reproduction*. In the preceding chapter we have made a preliminary study of the last named. Before we can learn more about the process of development it is necessary to have more information about the architecture of the living machine. So we shall now retrace our steps to what has been said already about the variety of response which animals exhibit and examine in greater detail the organs responsible for carrying them out.

I. THE EFFECTOR ORGANS

The effector organs which we shall first study are (*a*) the *chromatophores* or pigmentary effector organs responsible for reversible colour changes; (*b*) the various types of muscle fibre which execute the mechanical *movements* of talking and walking, peristalsis (the squeezing of food along the gut) or the beating of the heart; (*c*) *glands* which *produce chemical products or secretions* such as the saliva, sweat, or tears, the shell of the fowl's egg, the ink of the cuttle fish, the poison of a snake, or the slime of the slug; (*d*) *ciliated epithelium* which *maintains fluid motion* over body surfaces such as the inside of the human windpipe or the gills of a clam.

(1) *Pigmentary Effector Organs*.—Many animals, including reptiles such as the chameleon, a large number of fishes,

most frogs (*Frontispiece*), toads or salamanders, some shrimps, and a few leeches respond to changes in their surroundings by reversible changes of skin colour brought about by a characteristic type of effector organ. The behaviour of *chromatophores* is easy to observe in the translucent skin between the toes of a frog. If we take a frog that has been kept for some hours in a cold, dark room under water and transfer it to a dry receptacle in a warm, well-illuminated

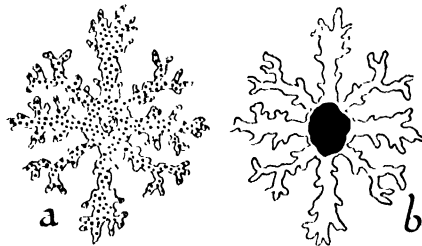

FIG. 13. BLACK PIGMENT CELLS (MELANOPHORES) FROM WEB OF FOOT OF FROG

a Expanded state, i.e. pigment granules dispersed. *b* Contracted state, i.e. pigment granules aggregated at centre of the cell. *a* is from a dark, *b* from a pale, animal.

situation, we can watch precisely what occurs in the skin during the process of transformation from a dark, almost black, tint to the pale yellowish hue which it finally assumes in the latter surroundings. Even with a good hand-lens we can see that the web is flecked with minute spots of blackish colouring matter or pigment. Closer observation with the low power of a microscope shows that in the completely pale animal each pigment spot is of rounded contour, but that in the intermediate condition it is star-shaped. In the dark animal each pigment spot becomes a rosette of fine threads of pigment interlacing with those of adjacent ones (Fig. 13). The changes in colour of the skin of the frog—and the same

is true of the skin of the chameleon—are due to the way in which the pigment is distributed in the skin. Each pigment spot in the pale animal is the centre of a profusely branching cell with a nucleus of its own. When the skin is dark, the pigment is found to be distributed through the whole length of the ramifying processes of the pigment cell, or, to use its technical name, *melanophore*. As the animal becomes paler, the pigment is gradually withdrawn along the cell processes until it is finally concentrated in a single compact speck at the cell centre. As was first shown by Milne-Edwards (1848), the melanophores are therefore the effector organs of colour response. Colour response in the frog, in the chameleon, and in fishes depends on the presence in the skin of effector organs which are single branching cells. These cells possess the peculiarity of containing a mobile colouring matter or pigment that migrates under appropriate stimulation along their cell processes.

Partly because the tint of two animals at the same extreme of pallor or darkening is never quite identical, and also because small differences in the configuration of the pigment granules are more easy to recognize than slight changes in the tint of the skin, the state of the melanophores, as seen in the thin web of the frog's foot, gives us a much more satisfactory means of studying the effect of external conditions on colour changes than does reliance on the tint of the animal. A suitable species for such observations is a near relative of the frog, the clawed toad *Xenopus* of South Africa. Though we cannot assess the shape of a melanophore with the precision with which we can measure the tension exerted by a muscle, we can analyse the response of a clawed toad to light by assigning arbitrary numerical symbols to different stages in the withdrawal or extension (contraction

or expansion) of the pigment in the melanophores, as indicated in Fig. 14. In biology, as in all branches of science, when we can reduce a problem to quantitative measurement we are in a better position to prescribe how to bring about a particular result.

Observation of a large number of toads placed in containers with black and white sides in dim and bright light gives rise to the impression that the optimum condition for pallor is afforded by placing the animals in a white container dimly illuminated from above, while a black container

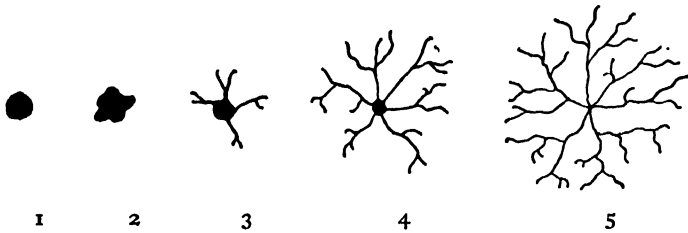

FIG. 14—STAGES IN "EXPANSION" OF MELANOPHORES (see text)

brightly illuminated from above is the optimum condition for darkening in *Xenopus*. The significance of this seemingly paradoxical result is at once evident when we record the extent of melanophore expansion in series of normal and eyeless toads, placed in white or black containers in dim and bright light in the manner indicated above. In the table given below the mean value for each series and the probable error of the mean value are cited.

The examination of these figures shows that there is a slight tendency of the *melanophores themselves* to become more expanded in bright light. This change is in the same sense as the characteristic response of the chameleon to light, a response which is also independent of the eyes, since it occurs in both normal and eyeless animals. A more striking

difference is revealed by the behaviour of normal toads when illuminated in white and black containers. Thus the response of normal toads is due to two components, a primary or direct reactivity of the melanophores themselves, and a secondary more sensitive response depending on whether the field of vision is occupied by a light-absorbing or light-scattering surface. In dim light the primary reactivity does not antagonize the secondary response to a light-scattering

COLOUR CHANGE IN *XENOPUS LAEVIS*

	White Container		Black Container	
	Dim Light	Bright Light	Dim Light	Bright Light
Normal Toads	1.65 ± 0.16	2.0 ± 0.0	4.25 ± 0.15	4.6 ± 0.13
Eyeless Toads	2.75 ± 0.18	3.13 ± 0.3	2.75 ± 0.23	3.0 ± 0.31

surface, while in bright light the primary reactivity reinforces the secondary response to a light-absorbing surface.

A similar experiment can also be carried out with the English common frog, but we get clear-cut differences only if we keep the temperature constant and perform the experiment wholly under either dry or wet conditions, or alternatively, if we compare the results obtained in dryness and in water at a constant warm and a constant cold temperature, leaving the animals for about a week to attain complete equilibrium. Pickle jars coated on the outside with white or black enamel, and covered with muslin are convenient for the purpose.

(2) *Muscular Movement*.—When we remove the skin in the region of the jaw or around the limbs, we find fleshy bodies attached at their extremities to the joints by tough material called *tendon*. These fleshy masses or muscles, on being teased, are found to consist of fine fibres arranged in parallel series, and beneath the microscope the fibres are seen as cylindrical objects with characteristic striations.

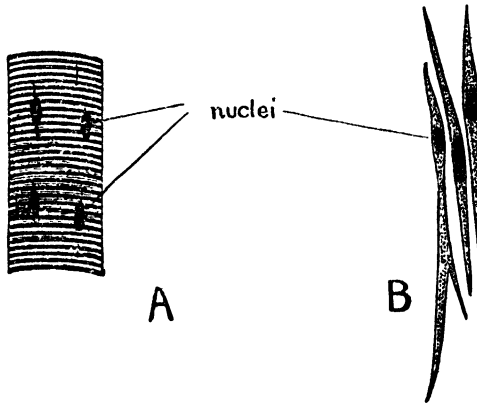

FIG. 15—MICROSCOPIC STRUCTURE OF MUSCLE
A, Part of a striped muscle fibre; B, Three plain muscle fibres.

Each fibre of *striped muscle* (Fig. 15), as it is customary to call the elements of the skeletal muscles (those attached to the skeleton or hard parts of the body), is derived in development from a single cell. But the nucleus multiplies without division of the cell body, so that the adult muscle fibre, which, though microscopic in girth, may be several inches in length, is eventually multinucleate. On flexing the arm, we notice that the muscles become shorter and thicker, because each fibre increases in thickness as it shortens in length. This shortening pulls on the bone or other hard part to which it is attached. A clear conception of this very

elementary fact is a comparatively modern discovery. Vesalius, the pioneer physiologist of the Renaissance, first clearly enunciated the idea that movement of the limbs was specifically due to a change in the fleshy portion or muscles in his epoch-making *Fabrica Humani Corporis* (1543). It

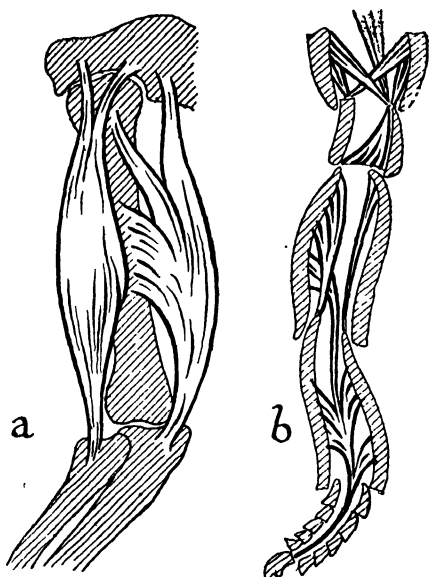

FIG. 16—RELATION OF MUSCLES AND SKELETAL PARTS (shaded)
a, Human forearm; *b*, Leg of an insect.

was not until the invention of the microscope that the nature of the muscle fibres could be studied. As late as 1662 Glisson first showed that when muscle contracts a change in shape, not, as previously believed, a change of bulk, occurs in each fibre (Fig. 19).

Muscles of the kind that consist of cylindrical fibres showing well-marked striations are concerned with the movements of the outside of the body, and are generally attached to some hard material which is called skeletal tissue.

In an insect they are attached to the horny outer covering of the body, which is divided up into separate segments or joints with thinner more flexible tissue between them serving as hinges (Fig. 16). In the frog and in ourselves, the skeletal tissues are internal and form a number of separate bones hinged by a tough fibrous material or tissue of whitish colour known as *tendon*, which also serves to bind the ends of the muscles to them.

The *skeleton of the frog* (Fig. 17) may best be described under four headings: the head skeleton, the visceral skeleton, the appendicular skeleton, and the axial skeleton. The head skeleton or *skull* consists of a protective case for the brain, partly composed of bone and partly of gristle or *cartilage*, and the jaws, which provide rigid levers for the muscles that open and close the mouth. Closely associated with the skull is the *visceral skeleton* or *hyoid* apparatus, a series of cartilaginous elements to which the muscles that are concerned in the movement of breathing are in part attached. They are the remains of the supporting arches of the gills in the tadpole (Fig. 138). The *appendicular skeleton* includes the limbs and their attachments to the trunk (the limb girdles). The names of the principal bones of the fore and hind limb are disclosed in the accompanying illustration (Fig. 17). The *axial skeleton* or *vertebral column* consists of a series of bones, the *vertebræ*, which collectively form a stiff supporting rod for the attachment of the muscles of the trunk. There are nine *vertebræ* in the frog, together with an elongated rod that represents a fusion of a number of the *vertebræ* of the posterior extremity. The latter is called the *urostyle*. Each *vertebra* consists of a main body or *centrum* and a more superficially situated arch (the *neural arch*) which invests the spinal cord (cf. Fig. 131, p. 340).

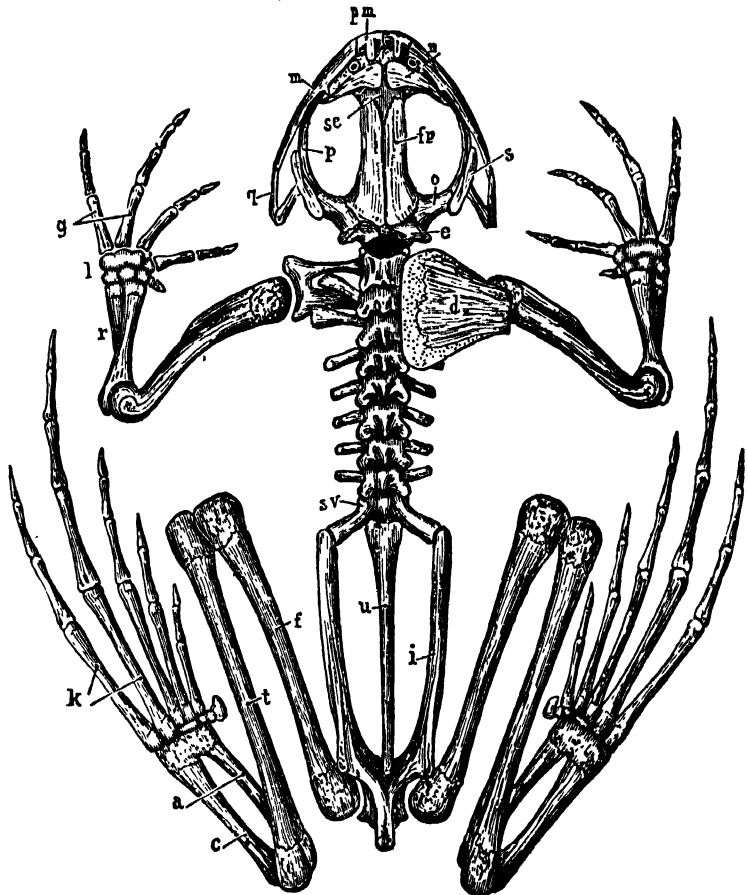

FIG. 17—THE SKELETON OF A FROG (*from Marshall*)

Note the skull, with cranium (fp), auditory capsules (o), nasal capsules (n), jaws (m, q, p) orbits (between cranium and jaws); backbone composed of nine separate vertebrae, and a rod (u) representing several vertebrae fused together; shoulder-girdle (the shoulder-blade (d) removed on the left side to show the ventral portions of the girdle); forelimb, with humerus (h), fused radius and ulna (r), wrist (l) and digits (g); pelvic girdle, the dorsal part of which (ilium, i) articulates with the sacrum (sacral vertebrae, sv); and hind-limb, with femur (f) articulating with the pelvic girdle, fused tibia and fibula (t), ankle with elongation of two bones astragalus (a) and heelbone or calcaneum (c), and digits (k).

The skeleton of an adult frog is mainly composed of the hard tissue called bone. The sternum, like the entire skeleton of a young tadpole, is composed of a stiff tissue called cartilage. Cartilage (Fig. 18) has a gelatinous matrix in which the cells are uniformly distributed. No blood vessels penetrate it. In the formation of true bone from cartilage blood vessels penetrate the matrix, and cells from the in-

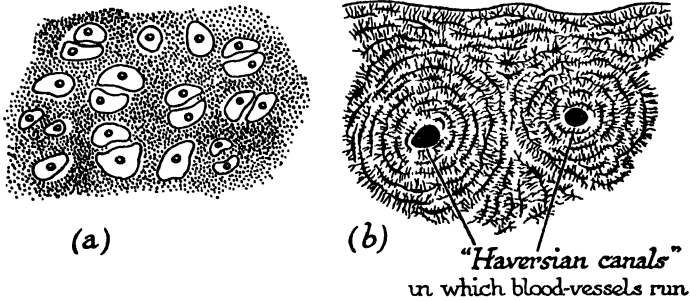

FIG. 18—COMPARISON OF THE MICROSCOPIC APPEARANCE OF CARTILAGE (a) AND BONE (b)

vesting layer migrate inwards. In the fully formed bone the cells are arranged in concentric layers around the blood vessels and the matrix, which is deposited in cylindrical laminæ between them, is impregnated with calcium phosphate. Calcium phosphate is also deposited in true cartilage as age advances; and such calcified cartilage is often difficult to distinguish from true bone unless its microscopic structure is examined.

The movements of the limbs and jaws, etc., are not the only visible movements of which the frog is capable. If you open the abdomen of a freshly decapitated frog, you will see the heart rhythmically contracting and dilating. If you apply a series of electrical shocks to the outside of the stomach, it will become noticeably constricted. By virtue of

this power which the walls of the gut possess, the food is squeezed from one end of the digestive canal to the other in the normal course of events. The actual process of squeezing is not easily perceived in the frog, because its gut does not always contain much food material. But if we open the abdomen of a decapitated rabbit before it is cold, we can see waves of writhing movement along the intestine. Galen (A.D. 170) understood that these movements of the gut and those of the uterus or womb, which assist in expelling the child from the body of the mother, are due to the action of the fibrous walls of the alimentary and generative tracts, when he wrote:

the fact is that the stomach possesses two coats which certainly exist for some purpose; they extend as far as the mouth . . . simple observation will show that these coats have their fibres in opposite directions. And, although *Erasistratus* did not attempt to say for what reason they are like this, I am going to do so. The outer coat has its fibres straight for traction. The inner coat has its fibres transverse for the purpose of peristalsis. . . .

The individual fibres of the muscular wall of the gut are single cells (Fig. 15, B) without the well-defined transverse markings of striped muscle. They are spindle-shaped and each possesses a single nucleus. Heart muscle in the frog is somewhat intermediate in microscopic appearance between the *smooth* or *plain* muscle of the gut, and the striped muscles of the limbs. The individual fibres are single cells with single nuclei, but they have distinct transverse striations.

The properties of these three types of muscle in an animal such as Man or the frog, while alike in their capacity to produce visible movements by shortening and thickening about their long and short axes respectively, are in other ways different. The power of contraction is an essential property

of the muscle itself, in no wise dependent on the rest of the body, except in so far as the latter ordinarily supplies it with working materials. After removal from the body, the frog's heart may be kept beating for days if perfused with a solution of salts like those in the blood.* Though the heart is

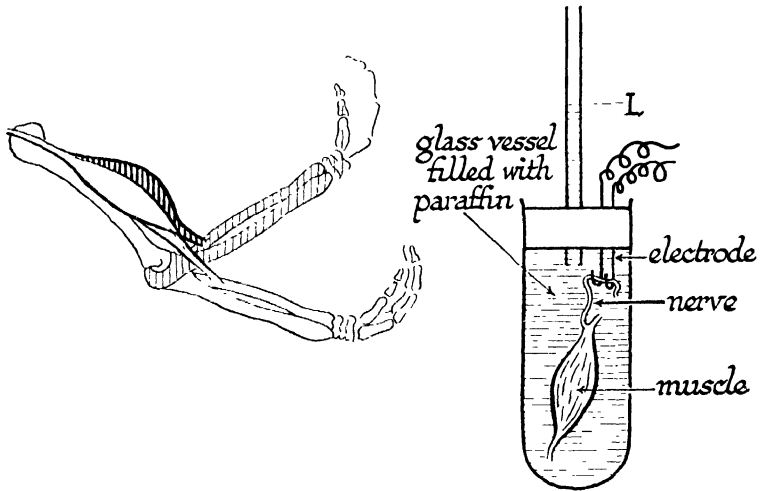

FIG. 19—MUSCLE CONTRACTION

When movement of limbs is produced by the contraction of a muscle (like the biceps) shape is not accompanied by any appreciable swelling (i.e. volume change), as shown by the constant level of fluid (L) in an air-free vessel containing a freshly exercised muscle and attached nerve which can be stimulated by an electric current. In an analogous experiment first done by Swammerdam during the seventeenth century, a fine piece of silk pulled the nerve against a loop of wire to stimulate contraction.

independent of the body to this extent, perfusion with a fluid similar in every respect except in having no calcium, brings it almost immediately to a standstill, restarting in a few seconds if the original perfusion fluid is again introduced

* One-eighth molar solutions of NaCl, KCl, CaCl₂ in the proportion by volume 100 : 2.5 : 1.5 is a suitable medium. A little NaHCO₃ (about 0.02 per cent) should be added to keep it slightly alkaline.

without too long delay (Fig. 1). This is a material fact about the machinery of the heart which is as controllable and as clear-cut as any experiment that we can carry out in the chemical laboratory. Isolated striped muscle such as the calf muscle (gastrocnemius) of the leg of the frog will also contract. If kept moist, it will do so for hours after removal from the body, when stimulated with electric shocks. The main difference between plain and striped muscle lies in the fact that striped muscle does not generally contract unless a special stimulus is applied to it, whereas plain muscle, like cardiac muscle, has a spontaneous rhythmical activity. When striped muscle is taken from the body, it is completely relaxed, whereas plain muscle is in a state of sustained partial contraction or *tone*.

(3) *Secretion*.—One very characteristic feature of the behaviour of amphibians (a group to which frogs and toads belong) is the readiness with which their skins emit a slimy material, especially if they are roughly handled or placed in water containing a little ether. The emission of this slime from the skin of the body is an illustration of the kind of response known as *secretion*. Glands are the parts of an organism which are concerned with the manufacture of what we call secretions. Spittle, phlegm, bile, sweat, etc., are examples of secretions. The simplest sort of glands are single cells, such as the mucous or slime cells scattered over the inside surface of the frog's intestine. Most glands are many-celled tubes or pockets of cubical cells with large nuclei and often with conspicuous granules (Fig. 20). The term was originally applied only to compact masses of such tubes packed together to form bulky organs of visible dimensions, such as the liver, pancreas (sweet-bread), etc.

The skin glands of a frog or a toad are simple pits of large

cells (Fig. 8), and the venomous secretion of the skin glands of some toads contains, in addition to mucous compounds which give to it a slimy character, a number of physiologically active substances. One of these is allied to the substance

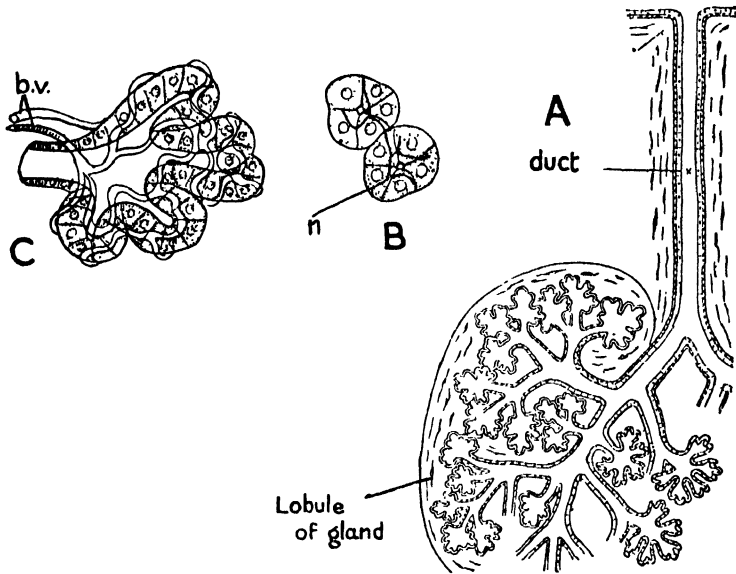

FIG. 20—GLANDS

A, Diagrammatic microscopic section through a lobule of a complex gland (Huxley). B and C, Microscopic sections through terminal secretory unit of the salivary gland of mammal, showing nerve (n) and blood-vessels (b.v.).

called adrenalin, secreted by the adrenal glands (Chapter VI). The sweat glands of the human skin are relatively longer coiled tubes, but likewise unbranched. Their secretory product is a watery solution of salts. The hygroscopic mucous secretion of the skin of an amphibian protects it against loss of water through surface evaporation. Increased skin secretion of a toad is also a response to mechanical stimulation of the surface of the body: possibly it aids the

animal to escape from its enemies by making it more slippery to grasp. Sweat secretion on the other hand is a response to increased temperature, and its evaporation on the surface of the skin has the effect of cooling the animal. It is part of an elaborate arrangement which preserves the tissues of mammals at a remarkably constant temperature well above that of their surroundings in most circumstances. Only birds and mammals maintain a constant body temperature above that of the medium in which they live.

(4) *Ciliary Motion*.—A form of response, which can easily

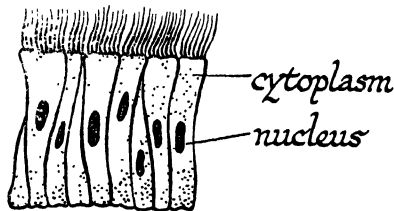

FIG. 21—CILIATED COLUMNAR EPITHELIUM

be observed in the common frog, is known as ciliary motion. We have already encountered it in describing the locomotion of *Paramœcium*; but the reader may not have expected to meet with it again in a more complex animal. If we cut out a strip of the skin of the roof of the frog's mouth, and examine it under the microscope, we are able to see at the edges that the whole surface is covered with a layer of cells (Fig. 21) provided with fine vibratile filaments or cilia, like those which cover the body of *Paramœcium* or *Opalina*. These cilia keep up movement of the slimy secretion of the mouth in the direction of the gullet. A few grains of charcoal sprinkled over the anterior end of the roof of the mouth of a frog killed by pithing* moves at a quite perceptible rate towards the throat.

* *i.e.* insertion of a needle into the skull cavity to destroy the brain.

The cilia of the same transverse row of cells beat together. The cilia of the row behind beat a short interval later so that the movement of all the cilia together resembles a field of corn blown by the wind. Ciliated epithelium occurs in man in the respiratory passages. It maintains a current of slimy secretion towards the nose. This prevents the accumulation of soot and other fine particles which would otherwise fill up the cavities of the lungs.

← Forward or Effective Beat

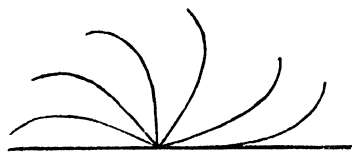

→ Backward or Recovery Beat



FIG. 22—DIAGRAM OF CILIARY MOTION

For the study of ciliary motion in the laboratory the common mussel (*Mytilus edulis*) affords a good illustration of a type of animal in which ciliary motion is a most important mode of response, since it is the agency by which the animal collects its food.

The main part of the body in the mussel is situated along the mid-dorsal line below the hinge of the shell (Fig. 23). On either side hangs down a fleshy film closely applied to the valve of the shell, and called the mantle lobe. The two mantle lobes enclose a cavity which communicates with the exterior only at the blunt end of the shell. This orifice is double, owing to the fact that the mantle lobes adhere at one point, so that there is an exhalant aperture separated by a thin sheet of tissue from an "inhalant" aperture lying below it. Through the inhalant orifice a current of water passes into the mantle cavity, at the opposite end of which is situated the mouth bounded by the fleshy labial palps. From the visceral mass hang down into the mantle cavity for the greater part of the

long axis of the body a pair of so-called "gills" (Fig. 23). Each consists of a pair of flat plates formed by the lateral approximation of a longitudinal row of filaments like the fringe of a lamp shade. This fringe of filaments is bent back to meet the body wall, so that each plate, or lamella, encloses a chamber which communicates behind with the exterior by way of the exhalant aperture. A slow, continuous current of water enters through the inhalant orifice, strains through the filaments which make up the lamellæ of the gills, passes backwards between the two halves of each lamella, and thence flows outwards by the exhalant aperture. It is maintained by the activity of cilia which line the sides of the filaments (Fig. 24). The whole apparatus is an animated filter; it strains minute suspended particles out of the water-stream, sorts them, and conveys smaller ones to the mouth. The gill-filaments secrete mucus. Entrapped in this slime, food particles are driven by the action of the cilia, which are also present on the exposed face of the gills, downwards to the lower margin of the lamella, which is grooved at its distal extremity. By ciliary motion of the cells

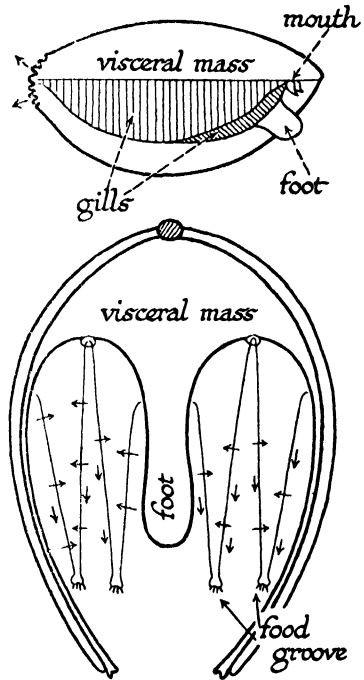

FIG. 23—DIAGRAM TO SHOW CILIARY CURRENTS IN THE GILL CHAMBER OF THE MUSSEL

Above—the animal as seen when one valve of the shell is removed; below—transverse section through whole animal.

which line these grooves, a slimy stream of food particles is lashed forwards and on to the labial palps. These have a ciliated groove maintaining a current into the mouth (Fig. 23). The rest of the surface of the palps is covered with cilia, which drive coarse, unsuitable particles away.

III. THE RECEPTOR ORGANS

Having outlined the effector organs which are involved in the most striking responses of the frog, we may now

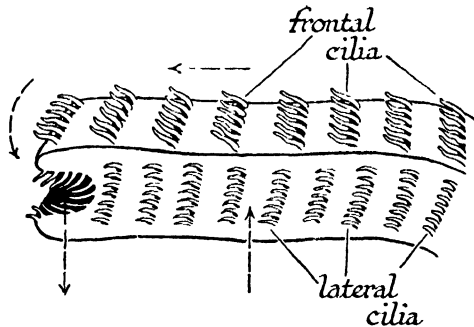

FIG. 24—GILL OF THE MUSSEL (diagrammatic)

Diagrammatic representation of a single filament to show the relation of different rows of cilia to the ciliary currents, which are indicated by arrows.

turn to a more detailed treatment of the receptor organs. At this stage we shall only deal with two of the more important receptors, namely, the Eye and the Ear. The normal movements of an animal are related to two chief types of stimuli, light and gravity.

Everyone is familiar with the fact that many insects fly towards a candle. Blow-fly maggots, if placed in a horizontal tube at right angles to a window, always move away from the direction whence the light comes. Examples of animal

responses other than movement evoked by the agency of illumination have already been cited. The influence of gravity is less familiar but just as important. Gravity is a powerful factor in maintaining normal posture, and the chief one which determines the power of a cat, when thrown into the air, to orientate its limbs in such a way that it falls on all fours. The way in which gravity influences animal locomotion may be shown by observing whether animals placed on a slope tend to move upwards or downwards. The influence of gravity on a few animals is so important that they invariably react in one way or the other. But, generally speaking, it is necessary to eliminate other disturbances in order to observe the influence of gravity on an animal's behaviour, as for instance by observing its reactions in the dark, when the influence of light on its movements is excluded. Many small freshwater shrimps, for instance, rise to the surface or sink to the bottom in the dark, some species moving away from and others in the direction of the pull of gravitation. One investigator, who has studied the behaviour of young loggerhead turtles, finds that they leave their nests and then crawl to the sea as the result of three responses which reinforce one another. Other things being equal, they move in the direction of the pull of gravity (positive geotaxis). They also move in the direction of the clearest field of illumination. Other things being equal, they move towards a blue source of light. The normal route of the young loggerhead turtle to the sea is a sloping beach with a clear horizon of blue. Given these responses to gravity and to the intensity and the colour of the light, one or all of the necessary stimuli will almost invariably be present to lead the animal to the sea in which it spends the rest of its life.

The ear of the frog and our own ear is the organ by which the influence of gravitation and the mechanical stimulus of sudden jerks are brought to bear upon the machinery of response. Our own ear, and to a much less extent that of the frog, is also a receptor organ for sound. Man differs from most other animals in the power of discriminating between sounds. In fact, sounds are the stimuli that call forth a very

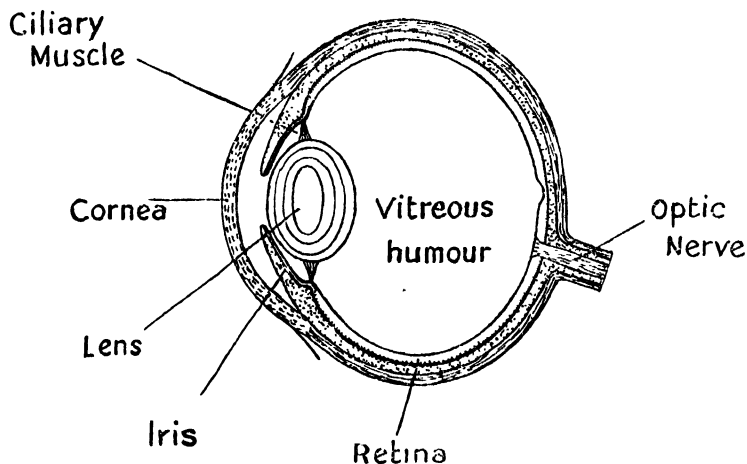

FIG. 25—THE VERTEBRATE EYE

large proportion of the responses of civilized life; for man alone has the power of speech well developed. The part played by the ear in determining an animal's position in space is of more general importance to animal biology. Outside the great group of Vertebrates, of which the fish, the frog, the turtle, the bird, and Man are types, it is doubtful whether any animals, except some insects, are susceptible to what we call sound stimuli. So far as we know at present, it is only in birds and mammals that this power is at all well developed. But almost all animals are influenced by the pull of gravity, just as almost all animals are influenced by light.

(1) *The Eye*.—In its gross construction the eye is very much like an ordinary camera. It consists of a box or capsule, a lens which focuses an image on the back of the box, and a layer of tissue, the *retina*, whose cells contain a substance chemically sensitive to light like the gelatin film of silver salt on the photographic plate or film. In front there is a transparent region of the tough and elsewhere opaque capsule. It is called the *cornea*. Behind, it is connected with the brain

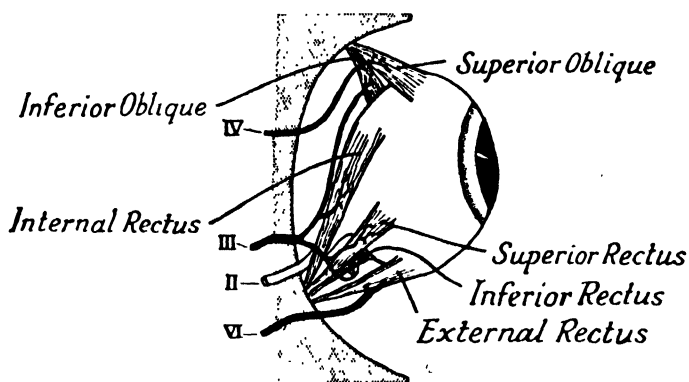

FIG. 26—THE VERTEBRATE EYE IN SITU

Showing associated muscles and their nerves from above.

by the *optic nerve*. Among the receptive cells of the retina is a layer of pigment cells somewhat like those which occur in the skin of the frog, for they are contractile in the same sense. These cells also occur in the eye of Man, which is essentially like that of the frog, and they are the only remains of the pigmentary effector system of the frog or the chameleon which the writer or reader of this book possesses. The layer of black pigment cells may be compared to the coat of black paint with which the inside of the box of the camera is covered.

Between the cornea and the transparent gelatinous bi-convex lens, there is a ring of circular muscles, the iris or pupil. The relaxation or contraction of the plain muscle of the pupil according to the intensity of the light increases or diminishes the size of the aperture, in a manner exactly analogous to the diaphragm of the camera. The wall of the box is partly muscular, so that the distance of the lens from the photographic plate or retina can be altered in much the same way as it is altered by the bellows of the camera. The lens is fixed in the box of the eye by tough tendinous tissue together with muscle fibres, called the ciliary muscle. The focusing of the human eye is performed by alteration of the shape of the lens through the contraction or relaxation of the ciliary muscles. The retina consists essentially of a layer of cells, the *rods* and *cones*, which contain the light-sensitive materials (Fig. 41). Their diameter is about one-ten-thousandth of an inch. The rods are like a very highly sensitive panchromatic plate, being affected by the intensity of light only. The cones are like a colour photographic plate, and they are not so sensitive as the rods, so that the colour, i.e. wave length of light reflected from different objects, is not so important in affecting an animal's behaviour in dim light as it is in broad daylight. The rods and cones are connected with a layer of nervous tissue which envelops them and is continuous with the optic nerve at the "blind spot."

The eye of the frog can be moved freely in its socket, like our own eye, by six muscles which will be referred to at a later stage. Very often the power to adjust the focus of the eye is inadequate to the requirements of civilized life. The eye may be too long, so that images from distant objects are focused a little in front of the retina, or too short so that images from near objects come to a focus behind it. In the

former case (myopia or short-sightedness) concave lenses, in the latter case (hypermetropia or long-sightedness) convex lenses of suitable curvature are used to effect the necessary adjustment. Another defect of the eye is encountered when the curvature of the cornea is not uniform. This peculiarity of the eye of many people is known as *astigmatism*, and can be compensated by lenses cut from the side of a cylinder, so

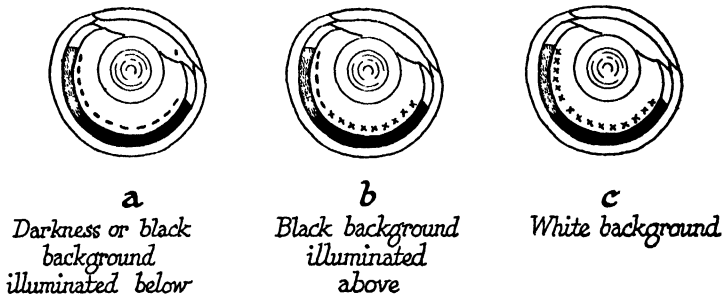

FIG. 27—DIAGRAMMATIC VIEW OF THE EYE OF XENOPUS TO SHOW REGIONS STIMULATED (×) BY OVERHEAD ILLUMINATION IN DIFFERENT SITUATIONS

placed in the spectacle frame that a suitable curvature is superposed in the plane which is relatively flatter.

The minute structure of the retina will be left till we have learned something about its nerve supply. Here it is sufficient to mention one way in which we can study how different parts of the retina call forth different responses. A type of animal response which is influenced by light is colour change. The table on p. 49 shows a customary feature of colour change to light reflected from the surroundings. In general, animals which become pale when illuminated in surroundings which scatter light (white "background") and dark when illuminated in surroundings which absorb light (black "background") are paler in darkness, or when exposed

to light after removal of the eyes. The colour of blinded animals is usually intermediate between that of animals kept on a white background, and that of animals kept on a black background. Under ordinary conditions of overhead illumination, all the light which enters the eye of an aquatic animal like *Xenopus* when it is kept in a black tank is compressed in a cone of which the half angle is the *critical* angle for air and water. Since the eyes are placed dorsally, the incident light is brought to a focus on a restricted area of the floor of the retina. If illuminated from below in similar surroundings, the animal behaves as if it were in darkness. This means that the retina is divisible into two regions (Fig. 27). The central region, when stimulated by light, initiates the black background response. The more peripheral region, when stimulated, initiates the white background response.

(2) *The Ear*.—The ear, as we have already seen, is a double structure. It will be best to describe its main features, and inquire later into the significance of its several parts, and since the part of the ear concerned with sound is poorly developed in the frog, we shall first examine the structure of the human ear, and later call attention to the main points of difference between the two.

The ear of Man (Fig. 28) consists of the following parts: the external ear or pinna, only present in mammals and not in all mammals, and capable in some of being rotated to collect sounds from different directions; a passage, the auditory meatus, that passes through a tunnel of bone ending blindly in an elastic membrane, the drum or tympanum; a cavity in the bone communicating with the back of the throat by the Eustachian tube; and finally a labyrinth of canals deeply embedded in the skull and communicating by

a small window with the cavity behind the tympanum. This labyrinth encloses a complicated sac, which is the most essential part of the ear, the sac and the space between it and its bony case being filled with a clear fluid. Across the space between the drum and the window of the bony labyrinth is a chain of three small bones, the auditory ossicles.

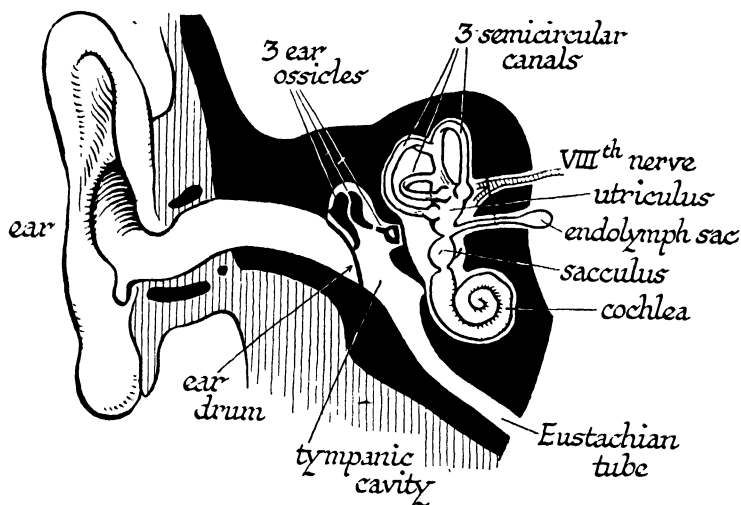

FIG. 28—THE HUMAN EAR

These transmit vibrations from the former to the latter. The innermost sac consists of three portions. The uppermost or utricle is continuous with three semi-circular canals at right angles to one another. Below it communicates with an elongated chamber, the saccule, which leads into the third spirally coiled portion known as the cochlea. In the latter, which is specially concerned with sound, fine microscopic fibres joined by a membrane are stretched across its walls. The internal surfaces of the utricle, semi-circular canals, and saccule bear patches of fine hairs in

which nerve fibres end. In the cavities of the utriculus and sacculus are small lumps of calcium carbonate, known as *statoliths*.

Toads and frogs have a tympanum with a single auditory ossicle. But they lack a cochlea. It was not until the early part of the nineteenth century that receptivity of the ear to agencies other than sounds was first suspected, when

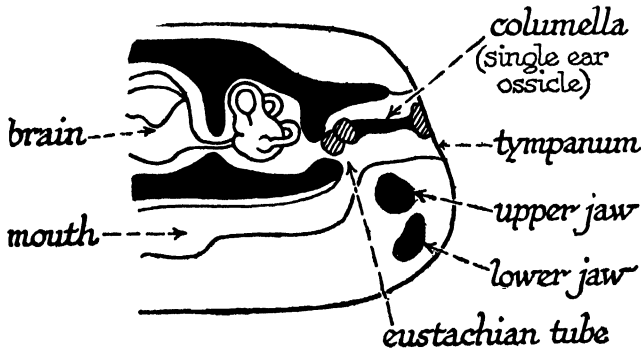

FIG. 29--DIAGRAMMATIC HALF SECTION THROUGH HEAD OF FROG
To show the auditory apparatus and labyrinthine organ.

Flourens (1824) investigated the effects of removing the semi-circular canals in pigeons. He discovered that it affected their power to balance and the orientation of the head.

The inner ear of an animal like the frog and the corresponding portions of our own ear are a rather elaborate form of a type of receptor organ that can be better understood in the simpler form in which it occurs—in jellyfishes, shrimps, and some clams. Near the base of the feelers of the shrimp is a little sac containing a concretion of sand. The sand can be replaced by iron filings, and when this is done, the shrimp swims upside down, when a strong magnet is placed above it. This shows that the position that the statolith occupies in the

sac which contains it determines whether certain muscles are brought into play (Fig. 30). A shrimp which has had both its feelers removed will swim in a normal manner in daylight, but if illuminated from below in a dark room, it will swim on its back, whereas a normal shrimp will always swim so that

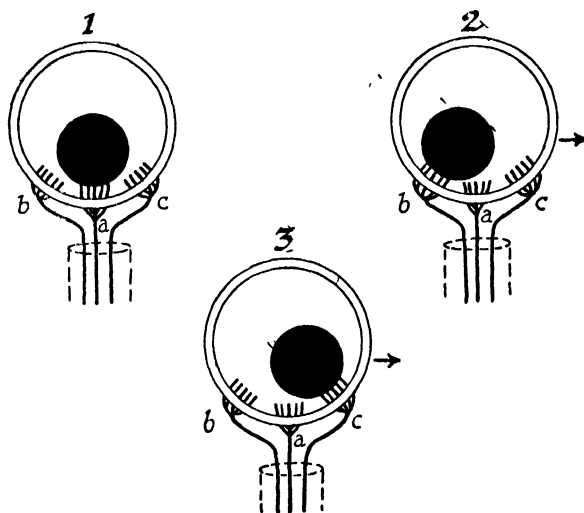

FIG. 30—DIAGRAM TO SHOW DISPLACEMENT OF STATOLITH IN THE STATOCYST OF A SHRIMP OR SQUID

1. Before the beginning of rotation.
2. Immediately after displacement in the direction of the arrow.
3. Immediately after cessation of movement in same direction.

its ventral surface is directed towards the pull of gravity. A shrimp with one feeler removed will swim normally in daytime. In the dark it will swim on one side. If both eyes and feelers are removed, it loses all power to balance itself in water. If one eye and one feeler are removed, it swims perpetually in a spiral path. These experiments show clearly that the normal posture of swimming depends partly on light and partly on gravity. So long as both the receptors for

either light or gravity are intact the influence of that stimulus is adequate to ensure the correct muscular responses. We shall go more thoroughly into this question when we have seen how it is that the effect of the external stimulus on the receptor organ travels to the effector organ, which carries out the appropriate response.

TOPICS FOR HOME STUDY

1. What is meant by ciliary motion, and what part does it play in the life of different types of animals.
2. Describe the microscopic changes which occur during colour change in frog and chameleon and how these changes are related to the external world.
3. Summarize the chief characteristics of the following tissues:
Blood, cartilage, bone, muscle, epithelium, nerve.
4. What receptor organs are involved in response of animals to rotation and disorientation in relation to gravity.
5. Explain how the eyes are accommodated to near and distant objects and how they move in the orbits.

CHAPTER III

THE MACHINERY OF CO-ORDINATION

WE have seen that the responses of an animal are carried out by structures (effector organs) localized in different regions of the body; that they are related to definite events in the external world; and that these events (or stimuli) are only capable of influencing the body through localized structures (receptor organs) not necessarily located in the same part of the body as that in which the appropriate response to their stimulation occurs. Hence arises the problem of *co-ordination*: what is the connecting link between receptor and effector? A disturbance occurs at one part of the body. Let us say, the image of a fly is focused on the retina of a frog. Its tongue shoots out. A fly settles on the back of a cow. She whisks her tail and flicks it away. How does the disturbance travel to the tongue in one case, and to the tail in the other?

Let us now study a single unit of behaviour, some action that is the normal consequence of a particular stimulus. Such a sequence of events is called a *reflex*, and some examples of simple reflexes, most of which can be easily studied in our own persons, are given in the table below:

SOME COMMON REFLEXES

<i>Action</i>	<i>Receptor</i>	<i>Effector</i>
Quickening of heart when its blood supply increases	Nerve - endings in right auricle	Heart muscle

SOME COMMON REFLEXES—*continued*

<i>Action</i>	<i>Receptor</i>	<i>Effector</i>
Contraction of pupil in strong light	Retina	Plain muscle of iris
Secretion of saliva on smelling food	Olfactory organ	Salivary glands
Sneezing after pepper	Olfactory organ	Muscles of chest and diaphragm
Knee jerk	“End organs” in tendon	Extensor muscles of thigh

A reflex that is very easy to demonstrate in the frog is the withdrawal of the foot, when the toes are allowed to dip into water warmed to about the temperature of the human body. If we suspend a frog which has been pithed (i.e. the brain destroyed) with the legs hanging downwards and bring a beaker of water gently into position, so that the toes just dip into the water, we find that nothing happens if the water is at the temperature of the room; but the leg is pulled up if the water has been previously warmed to about 40° C. If we time the interval between the immersion of the toes and the withdrawal of the limb, we find that it is a matter of seconds. Something has been happening during those seconds. *What happens and where it happens* is the aspect of behaviour implied by the term co-ordination.

The chief means of transmission of the disturbances set up in the receptor organs to the effector organs that carry out the ensuing responses is the *nervous system*. An instructive experiment can be carried out if we hang up five decapitated

frogs in the manner indicated above after snipping away the bone known as the urostyle (at the end of the vertebral column). This exposes two groups of shining white cylindrical trunks which are then seen to pass from the backbone downwards to the muscles of the legs. We can now learn what is the path by which the disturbance set up in the temperature receptors of the skin of the toes travels to the muscles of the thigh.

In one frog the white trunks (*sciatic nerves*) of both sides are left intact. In a second the sciatic nerve of the right side is cut. In a third frog the sciatic nerve of the left side is cut. In a fourth frog the sciatic nerves of both sides are cut. And in a fifth frog neither are cut, but a wire is passed down the backbone to destroy the central nervous system or *spinal cord*. Having done this we may try the effect of letting the toes of both feet dip into warm water. Both legs of the first frog are withdrawn. Only the left leg of the second and only the right leg of the third frog is withdrawn. Neither leg of the other two frogs is withdrawn. From this we conclude that the *something* which is happening between the immersion of the toes and the withdrawal of the foot travels by a definite road, namely along the sciatic nerve; and further that it travels first up to the spinal cord and then down to the leg muscles. This something we call the *nervous impulse*.

The Nervous Impulse.—Propagation of a disturbance from the receptor to the effector is a physical property of the kind of matter we call *nerve*. The nervous impulse is a physical event. It has space, time, and mass relations. The rate at which the nerve impulse travels can be determined exactly. This was first done by Helmholtz, in 1851, six years after Müller had stated that it was theoretically impossible to measure its velocity of propagation. The method employed

is very simple in principle, though special apparatus is necessary for the experiment (Figs. 31 and 32). It is convenient to use the sciatic nerve of a freshly pithed frog together with the gastrocnemius (calf) muscle which pulls up the

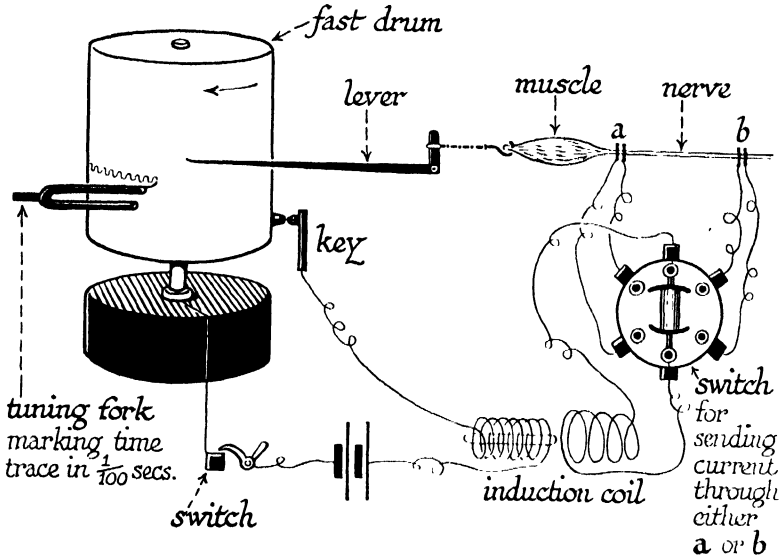

FIG. 31—APPARATUS FOR DETERMINING THE SPEED OF THE NERVOUS IMPULSE

A pin on the fast drum makes and breaks contact with the key when the tip of the lever is at the same point in each revolution. The current in the secondary is strongest at the break, and it is this which stimulates the nerve. Two records are taken, one with the secondary current passing through *a* and the other with it passing through *b*. The records are then compared as shown in Fig. 32.

leg. One end of the calf muscle is pinned to a moist board and the other is attached to a lever which records its contraction on a revolving drum. A certain time elapses between the application of an electrical stimulus to a nerve and the onset of contraction in the muscle connected with it. If the stimulus is applied at two successive points along the length

of the nerve, it is found that the delay is less when the stimulus is applied at the point nearer the nerve-muscle junction. If we divide the distance between the two points on the nerve by the difference in the delay, we obtain the rate at which the nervous impulse travels. In the frog the rate is about sixty miles an hour at the temperature to which it is normally exposed. In man the rate is about 200 m.p.h.

$$\frac{\text{length } ab}{\text{time } T_1 T_2} = \text{speed of impulse}$$

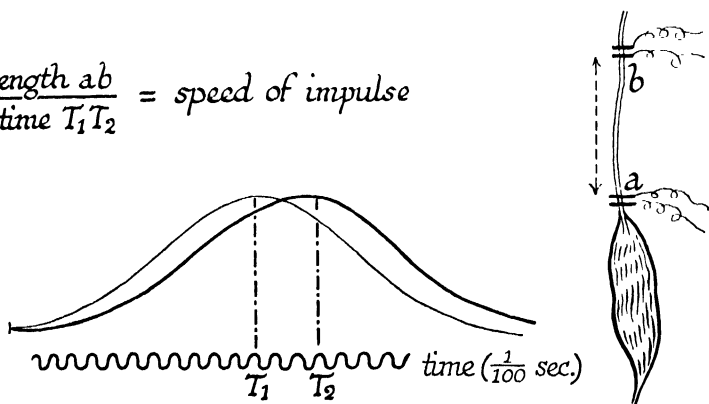

FIG. 32—THE SPEED OF THE NERVOUS IMPULSE

Muscle record showing delay of contraction when the attached nerve is stimulated at different points (*a* and *b*) along its length.

What is it that travels along the nerve at this rate? Reactions of dead matter are retarded or quickened by change of temperature. By carrying out experiments such as the foregoing it can be shown that the velocity of the nervous impulse varies in a definite way with change of temperature. The stimulation of nerve is also accompanied by a measurable increase in formation of carbon dioxide. In other words the nervous impulse is associated with the transformation of a measurable quantity of matter. These chemical changes that occur along the length of a nerve, when the nervous impulse

is said to traverse it, give rise to measurable electrical phenomena which can be measured by a sufficiently sensitive galvanometer.

A clear appreciation of the significance of the nervous system in the economy of the animal body came late in history. Galen, the foremost physician of antiquity, had no clear idea of the way in which disturbances are transmitted. A new understanding began in the year 1543, when Vesalius published his celebrated *Fabrica Humani Corporis*. Vesalius "dared not only to show how often Galen was wrong, but to insist that when Galen was right he was to be followed, not because he said it, but because what he said was in accordance with what everyone who took the pains to inquire could assure himself to be the real state of things."* In the chapter on vivisections in his great book, Vesalius showed that the action of this or that muscle can be abolished by cutting or ligaturing one nerve or another, and that the action of the muscle is restored by removing the ligature. This proved that the propagation of disturbances through the body is effected through the agency of the nerves. He also showed that transection of the spinal cord prevents the propagation of stimuli from the region above it to the muscles supplied by nerves emerging from the central nervous system below the section.

It is customary to distinguish the brain and spinal cord of the frog as the *central nervous system* (commonly written C.N.S.) in contradistinction to the other nerve cords which connect it with the receptor and effector organs of the body. The central nervous system was not clearly recognized to be the turning point in the road which the nervous impulse travels until 1751, when Whytt showed by experiments on

* Foster, *History of Physiology*.

frogs that destruction of the spinal cord abolishes reflex actions. Before we can get a deeper insight into the adventures of the nervous impulse as it travels first towards the central nervous system, and thence outwards to the muscles, glands, etc., we must examine the microscopic structure of nerves.

Structure of the Nervous System.—If we tease a nerve like the sciatic nerve of the frog with needles we can separate it into a large number of cylindrical fibres, each of microscopic thickness and each surrounded by a minute sheath of fatty material. By tracing these fibres back to the spinal cord, we eventually find that they are simply attenuated processes of branching cells. Some of them originate from branching cells in the *grey matter* or core of the spinal cord, where their finer branches are closely connected with the terminal branches of other nerve cells or *neurones*. Branching cells of this type also occur in the central nervous system itself. Their fibres (*propriospinal*) run up and down the outer rind or white matter of the spinal cord, carrying nervous impulses from one level to another. Others of the fibres of a mixed nerve, i.e. a nerve carrying impulses both to and from the cord, like the sciatic nerve of the frog, do not have their cell bodies within the spinal cord. Their cell bodies are in swellings known as the dorsal root ganglia, situated near where the nerve is joined to the cord. We shall have more to say about these ganglia later; it suffices for the present to note that the term ganglion is used for any part of the nervous system in which the cell bodies of nerve fibres are congregated. The cells of the dorsal ganglia send branches into the spinal cord, where they arborize around the cell bodies found in the grey matter. A single nerve fibre, with its sheath, in a Vertebrate animal, is not more

than a hundredth of a millimetre in thickness, though in ourselves it may be as much as a yard in length.

The experiment cited on p. 75 indicates that a nerve like the sciatic nerve of the frog is a bundle of fibres, some carrying nervous impulses in either direction. It does not tell us whether impulses normally travel in both directions in

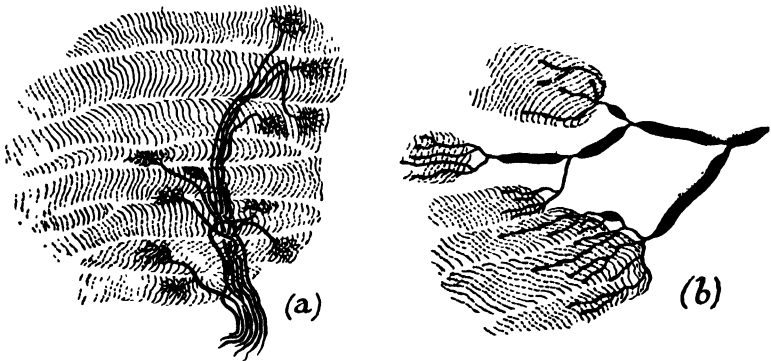

FIG. 33—NERVE ENDINGS IN STRIPED MUSCLE

(a) Motor (efferent) and (b) Sensory (afferent). The afferent nerves are *proprioceptive* as opposed to *extero-ceptive* nerves such as the optic and auditory nerves or afferent nerves of the skin. They record the stretching of the muscles.

the same neurone or whether some neurones are *afferent*, carrying impulses from the receptor to the cord, and others *efferent*, carrying impulses from the cord to the effector organ. Other experiments show that most nerve trunks contain two different types of neurone. If we trace any nerve back to the spinal cord, we find that it is connected with it by two separate trunks, the dorsal and ventral roots, the former of which are swollen and contain, as stated, cells, from which fibres pass in both directions, towards and away from the cord. If we cut a spinal nerve at its peripheral end, muscular contractions can be elicited by electrical stimulation

of the nerve *on the central side of the cut*. After cutting the dorsal root these reflexes will not be obtained. This shows that all the afferent impulses pass into the cord by the fibres whose cells are located in the dorsal root ganglion. If the dorsal root of the cut nerve is left intact, section of all other dorsal roots of the remaining spinal nerves does not interfere

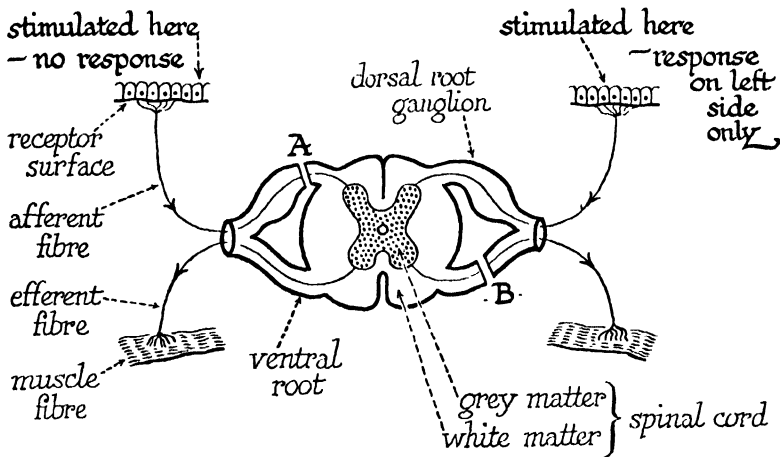

FIG. 34—DIAGRAM TO ILLUSTRATE MÜLLER'S EXPERIMENT
Dorsal root cut at A; ventral root cut at B.

with the reflex response obtained by stimulating its central end. This shows that all the efferent fibres leave the cord by the ventral root. The separate connexions of the afferent and efferent neurones to the C.N.S. were finally established by Johannes Müller (1834) who severed all the dorsal roots on one side of the body of a frog, and all the ventral or motor roots on the other side (Fig. 34). Such an animal shows complete indifference to stimuli on the side on which the dorsal roots are cut and complete inability to respond by active movement on the opposite side, but stimuli applied

to the side on which the dorsal roots are intact will evoke response on the side whose motor roots are intact. Magendie (1812) had found the same rule to hold good for the dog, Panniza (1834) established its truth in the bird, and later workers, including Stannius, applied it successfully in experiments on fishes. The presence of separate afferent and efferent roots is a peculiarity of the nerves of Vertebrates (fishes, amphibia, reptiles, birds, and mammals) and experiments like the one just described have been carried out on representatives of all the Vertebrate classes.

Microscopic sections or teased-out preparations of a mixed nerve are not sufficient to justify the inference that all the fibres of a dorsal root have their cell bodies in the dorsal root ganglion or that all the fibres in the ventral root have their cell bodies in the grey matter of the cord. The microscope enables us to see that fibres from the cells in the dorsal ganglia pass a certain distance towards and away from the C.N.S. and that the fibres of the cells in the grey matter pass out into the ventral root. We can only trace them by direct observation for a small fraction of their course, and then lose track of them. Here experiment comes to our aid. If we cut a mixed spinal nerve, and keep the animal alive, microscopic examination shows that all the fibres on the side of the nerve remote from the C.N.S. undergo degenerative changes in the course of a few days. If we cut the dorsal root on the *central* side of the ganglion (i.e. nearest the cord) all the fibres on the *central* side of the cut degenerate. If we cut it on the *peripheral* side of the ganglion all the fibres on the *peripheral* side of the cut degenerate. If we cut the ventral root, we find that degeneration occurs only on the side *remote from* the central nervous system. This means that if cell bodies occur in any tract of nerve tissue, the fibres

degenerate on the side of section remote from the seat of cell bodies. In other words, a fibre not connected with its cell body undergoes degeneration. By applying the method of degenerative section combined with direct observation of microscopic preparations we are therefore able to reconstruct the nerve paths involved in a reflex (Fig. 36).

The simplest possible path of a reflex (reflex arc) is by the way of a fibre having its cell in the dorsal ganglion into the

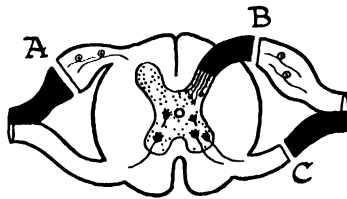

FIG. 35—DIAGRAM TO ILLUSTRATE EFFECT OF REGENERATIVE SECTION OF NERVE ROOTS

Degenerated regions black. A, dorsal root cut on peripheral side of ganglion; the afferent fibres to the left have degenerated. B, dorsal root cut on central side of ganglion; the ends of the afferent fibres carrying impulses into the grey matter of the spinal cord have degenerated. C, ventral root cut; the efferent fibres to the right have degenerated.

cord, across the thin membrane (or *synapse*) separating the ultimate branches of such a fibre in the grey matter from the branched cell body of an efferent neurone, whose fibre passes out by the ventral root. The latter fibre is bound up with many other fibres, carrying impulses inwards or outwards, in a nerve trunk. Such is a very simple type of nerve path involved in reflex action. Generally a reflex path involves additional neurones, which are confined within the C.N.S. There are large numbers of neurones whose whole length is confined to the C.N.S., running up or down, carrying impulses from afferent neurones at one level to efferent neurones at another. Two great meeting places within the C.N.S., for

neurones which run forwards to the head and backwards to the posterior extremity of a Vertebrate, are the two parts of the brain known as the cerebrum and cerebellum. When the brain is destroyed these paths are eliminated: and partly for

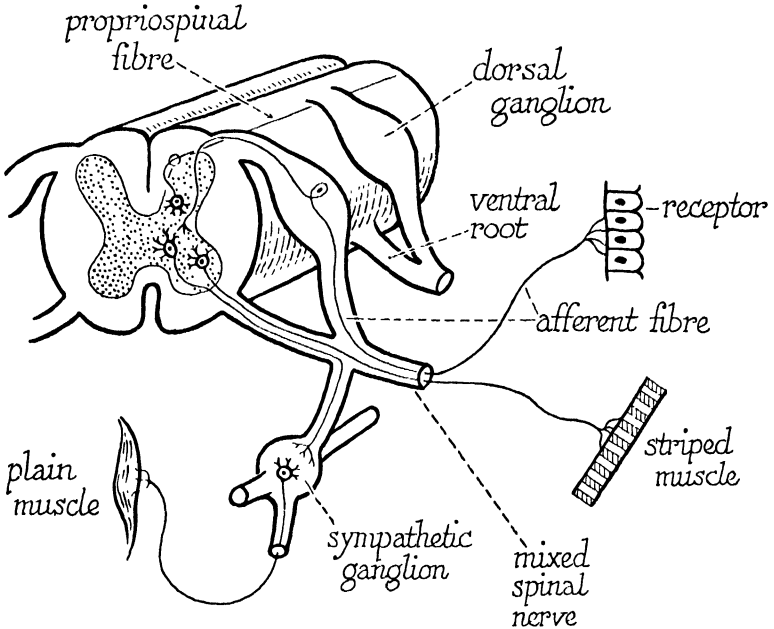

FIG. 36—DIAGRAM OF THE REFLEX ARC

this reason, partly for others which will be referred to later, the behaviour of the pithed frog is much simpler, and therefore more suitable for the study of reflex action than that of the normal animal.

The existence of nerve tracts running up and down the spinal cord can be demonstrated in a very simple way. When a dark chameleon, i.e. a chameleon which has been kept a few minutes in bright light in a cool room, is stimulated by an alternating current from a shocking coil by

electrodes applied either to the roof of the mouth or to the anal orifice, the animal becomes extremely pale after about a minute. If the spinal cord has been cut with a pair of dissecting scissors about the level of the eighth vertebra

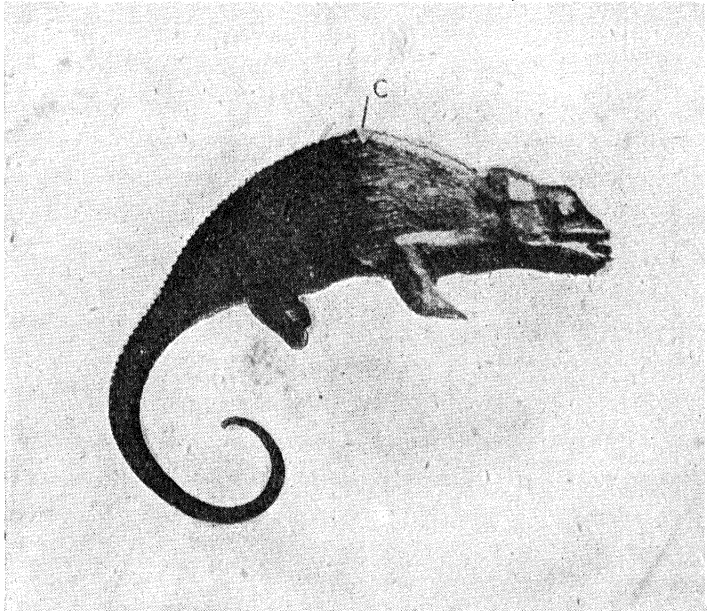

FIG. 37—EFFECT OF FARADIC STIMULATION OF THE ROOF OF THE MOUTH IN THE CAPE CHAMELEON WHEN THE SPINAL CORD IS SEVERED AT C

generalized pallor does not result from stimulating the mouth. The skin becomes pale only in the half of the body in front of the cut. After stimulating the cloaca the body becomes pale only on the posterior side of the cut.

The nerve fibres that supply the striped muscles of the limbs, etc., have their cell bodies in the grey matter of the cord.

The nerve supply of the smooth muscles, of the muscles of the heart and of the glands (as well as that of the pigment cells of the chameleon or fish) is somewhat different. Connected with each pair of spinal nerves by fine trunks known

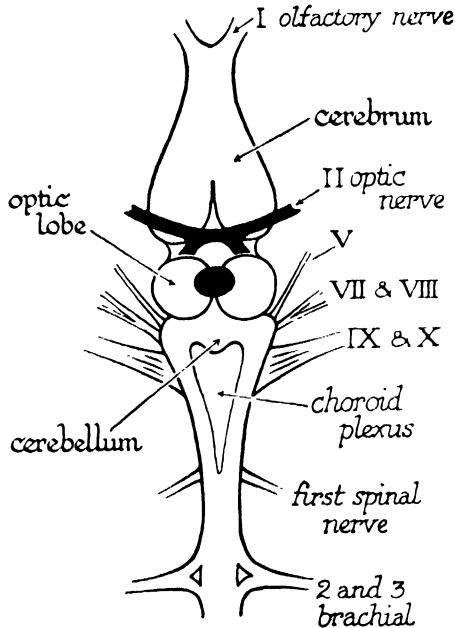

FIG. 38—BRAIN OF FROG

The optic nerves (II) and pituitary body, represented in black, lie on the ventral side of the brain. The rest of the picture is a dorsal view.

as *rami communicantes* are certain swellings of nervous tissue containing nerve cells as well as fibres and therefore called ganglia, or usually *sympathetic ganglia*. When the rami or ganglia themselves are stimulated by an electrical current from a shocking coil, characteristic responses of the musculature of the gut, walls of the arteries and generative passages, glands, etc., occur. When the ganglia are painted

with the drug nicotine, stimulation of the rami does not evoke these responses. Since painting the nerves themselves does not prevent their ability to transmit impulses, nicotine appears to act primarily on nerve cells which occur in the ganglia. These nerve cells belong to neurones which supply the gut, glands, etc. They can be distinguished from efferent neurones which supply striped muscle *via* the spinal nerves and from the nerve fibres which pass out of the cord to the ganglia *via* the rami communicantes, because no fatty sheath (*medulla*) surrounds the fibre itself. The nerve fibres that originate in the ganglia are therefore called non-medullated fibres. The fact that nicotine prevents the conduction of nervous impulses beyond the ganglia by paralysing their nerve cells shows that plain muscle, glands, etc., of the body are not directly innervated by the fibres with cells in the grey matter of the cord. Impulses leaving the C.N.S. for effector organs other than striped muscle pass in the ganglia to a second relay of neurones. Thus the sympathetic ganglia are distributive centres which permit impulses arriving from the cord along a single fibre to set up relay impulses in large numbers of non-medullated fibres going to different destinations.

In the region of the spinal cord—the part of the C.N.S. of a Vertebrate enclosed by the spinal column—a pair of nerves with motor and ganglionated roots arises between each pair of vertebræ. The main nerves to the limbs, such as the sciatic nerve, are formed by the union of several of these. The anterior end of the C.N.S. is considerably swollen and enclosed within the skull. From this region, the brain (Fig. 38), ten pairs of nerves called *cranial nerves** come off in

* Two additional nerves of Man (and other mammals)—in reality typical spinal nerves—are incorporated in the skull cavity.

the frogs and ourselves. These nerves—especially those of the anterior end of the brain—are not built on the same plan as the spinal nerves. The same nerve does not always contain both afferent neurones and efferent neurones supplying striped muscle. They have technical names, but are conventionally denoted more briefly by roman numerals. Starting from the most anterior pair they are: I. The Olfactory nerves from the nasal receptor surface: purely afferent. II. The Optic nerves from the retina: purely afferent. III, IV, and VI are efferent nerves supplying the striped muscles which move the eye in its socket. In the frog, in man, and in other Vertebrate animals there are six of these in each eye socket or orbit. They are called the anterior, posterior, dorsal, and ventral rectus muscles, and the dorsal and ventral oblique muscles (Fig. 26). The anterior (internal) rectus, the dorsal (superior) rectus, and the ventral (inferior) rectus and oblique muscles are innervated by III. The posterior or external rectus is innervated by VI and the superior or dorsal oblique by IV; VIII is a purely afferent nerve with two divisions from the two separate portions (utricle and cochlea) of the ear. The remaining cranial nerves, V, VII, IX, and X contain afferent neurones—V from the skin of the face, and in the mammals the pulp cavities of the teeth, VII from the skin of the face, and in the mammals the receptive surface of the tongue, IX and X from the respiratory and digestive tracts. These nerves (IX and X) contain some efferent medullated fibres with cells in the brain. Some of them supply muscles of the face and throat. Others end in connexion with short non-medullated neurones in the musculature of the gut or heart. Stimulation of the Xth or Vagus nerve of the frog, as in our nearer allies (e.g. rabbit or dog), always results in slowing and enfeebling of the heart beat. This nerve exerts a restraining influence on the

rhythm of the heart. It is an interesting fact that the stimulation of the vagus nerve always has the opposite effect to

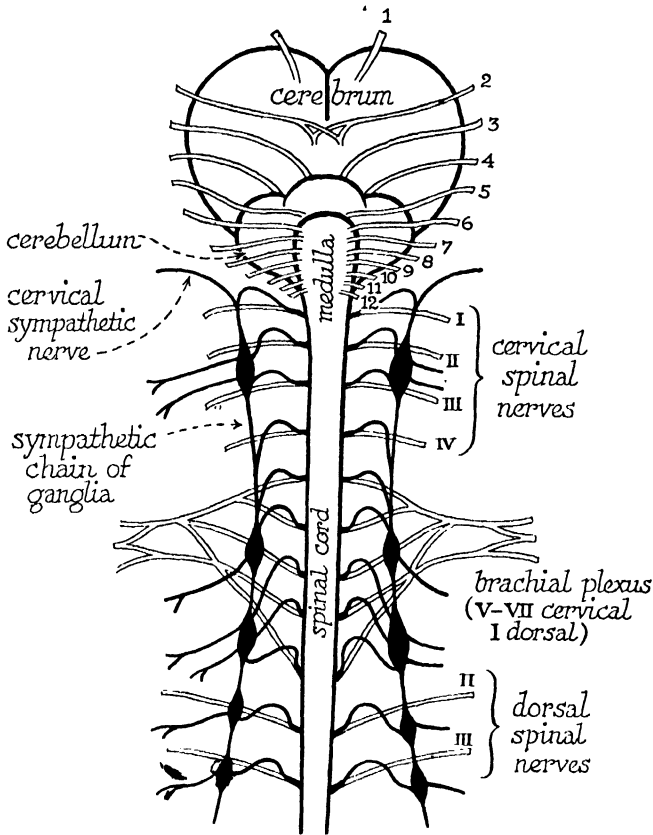

FIG. 39—DIAGRAMMATIC REPRESENTATION OF THE CENTRAL NERVOUS SYSTEM OF MAN

the stimulation of the spinal sympathetic nerve supply of any particular effector. Thus stimulation of the sympathetic nerve produces relaxation, stimulation of the vagus contraction, of the muscular wall of the gut. Stimulation of the

sympathetic nerves to the heart increases the rate and power of its beat.

With two exceptions the cranial nerves which contain *afferent* fibres have ganglia near where they join the brain,

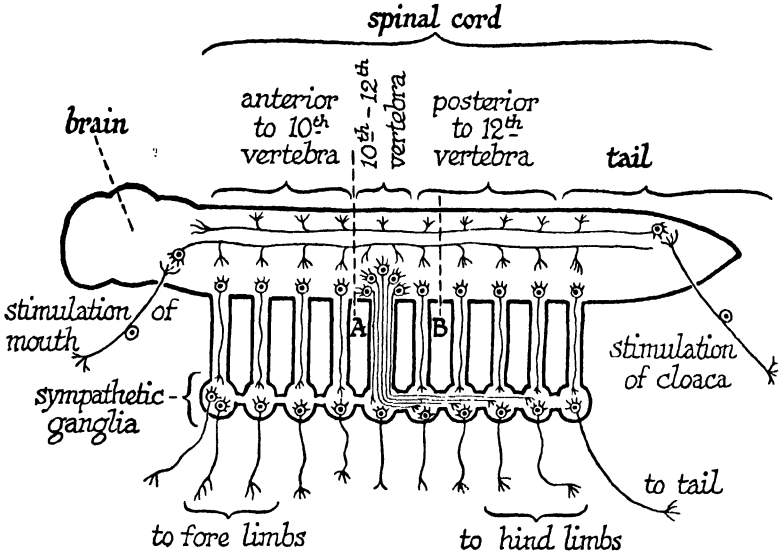

FIG. 40—DIAGRAMMATIC REPRESENTATION OF THE NERVE PATHS INVOLVED IN THE CONTROL OF THE PIGMENTARY EFFECTOR SYSTEM OF THE CHAMELEON

For the purpose of diagrammatization the number of ganglia is reduced and the ascending and descending afferent paths from cloaca and mouth respectively are represented in each case by a single neurone. Section of the cord alone anterior to *A* restricts the pallor following stimulation of the mouth, to the region in front of the cut. After section of the cord alone at the level indicated by *B*, stimulation of the roof of the mouth produces generalized pallor of the whole animal with the exception of the tip of the tail.

and the fibres have their cell bodies located in them, as afferent neurones of spinal nerve have their cell bodies in dorsal root ganglia. The olfactory and optic nerves are built on a different plan. They have no such ganglia. The cell bodies of the optic nerve fibres are located in the superficial

layers of the retina (Fig. 41), where they enter into synaptic relation with very short neurones of the middle layers. These short neurones are directly connected with the photo-receptive elements, which are of two types, respectively called *rods* and *cones*. Only the latter are concerned with

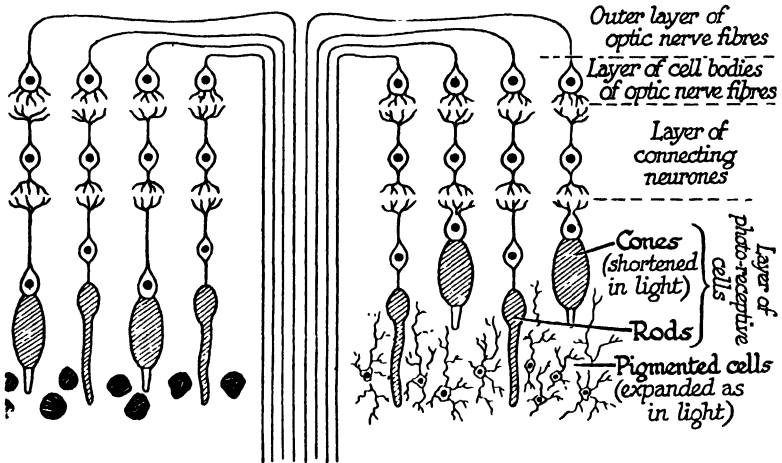

FIG. 41—DIAGRAM OF THE HUMAN RETINA

Diagram of the microscopic structure of the Retina of the Vertebrate Eye drawn through the blind spot where the optic nerve enters the eye. The pigment cells are *contracted* and the cones extended on the *left* side as in darkness. Incident light on right side from *above* downwards.

colour discrimination. The localization of cell bodies of afferent neurones near the junction of nerves with the central nervous system is characteristic of Vertebrates. In other animals which possess a central nervous system the afferent fibres have their cell bodies in the receptor organ, like the fibres of the first two cranial nerves of a Vertebrate.

The brain itself is the part of the C.N.S. which receives impulses from the most important receptor organs—the eye, ear, and olfactory membranes, transmitting them by the descending neurones within the C.N.S. to the efferent

neurones that arise from the cord at different levels. For anatomical description it is—somewhat arbitrarily—divided into three regions: the *fore-*, *mid-* and *hind-brain*.* The fore-brain consists of two parts, a more anterior portion, the dorsal aspect of which is called the *cerebral hemispheres*, and a more posterior portion which is narrower (the *thalamencephalon*) and bears two interesting glandular structures on its roof and floor. The former is the *pineal* body which in some lizards has an eye-like structure. Whether it is of any importance to the frog we do not know—probably it is not. The second is called the *pituitary* gland. Of this organ we shall have more to say later. The roof of the mid-brain is defined by two globular lobes, the so-called *optic lobes*. The hind-brain is poorly developed in the frog. Its roof in the human being is called the *cerebellum*. The first two pairs of cranial nerves arise from the fore-brain, III arises from the floor of the mid-brain, IV emerges dorsally between the mid- and the hind-brain, and V–X arise from the floor of the hind-brain. A frog in which the brain has been destroyed may be kept alive indefinitely; and its behaviour is very much simpler and therefore more easy to predict after careful study. It is no longer subject to the very varied stimuli of ever-changing images from the retina, and of smells or noises in its vicinity. The interplay of all these helps to make the behaviour of the intact frog a much more complicated affair.

The Study of Behaviour.—When the influence of one group of stimuli, e.g. light, predominates over all others, it is possible to see how simple reflexes like the ones we can study in the pithed frog determine the normal behaviour of an intact animal. Thus it is proverbial that certain insects move towards the light. A generation ago we should have

* See Appendix IV, p. 403.

said they move towards the light because they like the light. This tells us nothing. It is not really very different from the habit of mind which made the alchemist speak of "spirits" of nitre, "spirits" of salt, etc., attributing to personal agencies all the properties of dead matter as the savage peopled his universe with unseen beings. In general the phototactic movements of insects depend on two facts: (a) light acting

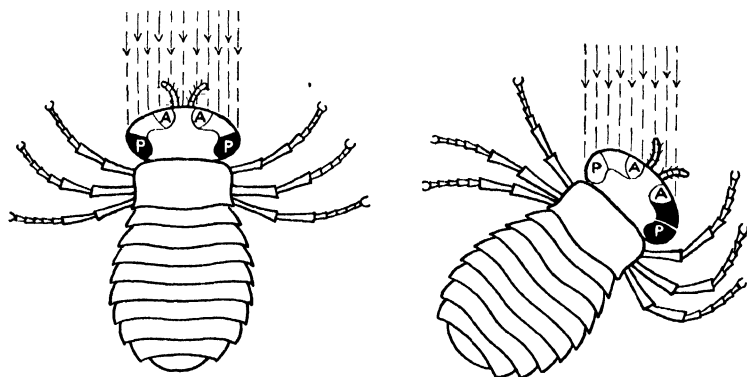

FIG. 42—DIAGRAM TO ILLUSTRATE MOVEMENT OF INSECT (HOVER FLY) TOWARDS THE LIGHT (see text, p. 93).

on the same region of the same eye reflexly increases the tension of muscles on one side of the body and reflexly relaxes the same ones on the other; (b) light acting on one part of the eye produces *contraction* of a particular group of muscles and light acting on another part of the same eye produces reflex *relaxation* of the same group of muscles. Thus if one eye of the hover fly, *Eristalis*, is blackened, a beam of light focused on the anterior margin (A, Fig. 42) of the other eye makes the animal bend the legs of the same side forwards and the legs of the other side backwards, so that the body tilts away from the side illuminated. If a beam is directed on the posterior edge (P, Fig. 42), the legs of the opposite

side are bent forwards and the legs of the same side backwards so that the body tilts towards the side illuminated. A comparatively feeble beam acting on the posterior margin will compensate the effect of an intense illumination of the region in front. When a fly is moving along a beam of light the posterior edge of neither eye gets much light and one gets as little as the other. When it is deflected to the right, the posterior margin of the left eye gets more light (Fig. 42) and this brings about the tilting of the body to the left. Its direction of movement is at once restored, so that the eyes are illuminated symmetrically. This is only realized when the axis of the body is in line with the source of light.

With the knowledge that we now have, we can form a clearer picture of the way in which such a receptor as the statocyst of a shrimp, or its more complicated counterpart the membranous labyrinth or inner ear of the frog, performs its role in the maintenance of normal posture. The inner wall of the statocyst of the shrimp is covered with cells provided with fine hairs projecting into its cavity (Fig. 30). These cells are connected with the ends of separate nerve fibres. The effect of a jerky movement is that the statolith hits the wall of the statocyst as our bodies hit the wall of a train if it starts suddenly when we are standing up. Hence it strikes a new set of sensitive hairs. If different nerve fibres of the statocyst belong to reflex arcs involving different sets of muscles, one or another set of muscles will be brought into play by the mechanical stimulus of the statolith resting on one or another set of hairs (Fig. 30). This, roughly speaking, is the mechanism underlying the fact that a cat falls on all fours.

In the spinal cord or brain of an animal like the frog (or the writer of this book) the neurones do not lie in isolated

reflex arcs, but each is connected by its ramifying branches to a number of others. The occurrence of any reflex implies that impulses pass across the junction between two particular neurones more readily than across the junction of the same neurones and all others. That is to say, reflex action is a physical property of the *junctions* between nerve endings in the C.N.S. Seeing that the animal is subjected to innumerable stimuli simultaneously in normal life, its behaviour would be quite chaotic were it not for an important feature of reflex activity. Suppose the stimulation of a receptor A produces relaxation and of B produces contraction of a certain muscle, which in ordinary conditions is in the state of steady incomplete relaxation known as *tone*. Both reflexes have common efferent connections, called by Professor Sherrington a "final common path." When A and B are stimulated simultaneously, either A holds the field alone or B; that is to say, the response is exclusively characteristic of stimulating either A or B alone. Now in the C.N.S. the number of fibres running up and down are by no means infinite in number, and enormous numbers of reflexes share common paths in the cord. The fact that one group of receptors can use a common path to the exclusion of any antagonistic reflex system makes the behaviour of the animal more stable and definite than it would otherwise be.

The Nature of Conscious Behaviour.—The relatively simple behaviour of the pithed frog as compared with that of the intact animal is not exclusively due to the fact that the influence of the great sense organs of the head is eliminated, nor to the fact that many of the possible ascending nerve paths, which converge on descending ones at a higher level, are cut across. To some extent—far less than the reader or writer of this book—the frog can, in the language of every-

day life, *learn*. The word learning is given to several ways in which the behaviour of an animal can be modified by past experience. One way is that a stimulus which has been repeated a large number of times can become the signal for a response which it did not formerly call forth. The appropriate conditions can now be studied by experiment and described in the language of science.

The ability to build up new reflexes under definitely ascertainable conditions is a physical property of the fore brain or cerebrum. Noteworthy progress in defining the conditions under which new reflex systems are built up has been made during the present century by the Russian physiologists of Pavlov's school. This is a very revolutionary development of modern science, because it brings within the realm of scientific treatment a body of experiences which have hitherto been the province of metaphysics. The fact that it is now possible to study the machinery by which the effect of previous stimuli modify the behaviour of an animal at any given moment, brings within the scope of scientific treatment animal characteristics which have hitherto been ascribed to non-measurable agencies such as "memory," "consciousness," "sensation," and the like.

The capacity to learn is one of a number of characteristics of behaviour which distinguish the intact frog from the brainless frog. These characteristics correspond to what are called in traditional language "conscious behaviour." At one time it was customary to assume that the behaviour of an animal can be treated under two headings, "reflex" activity which we have referred to briefly above and "voluntary activity" or "conscious behaviour." The former alone was regarded as the proper domain of the biologist, the latter as the province of moral philosophy. The success of Pavlov's

researches show that conscious behaviour can be studied scientifically and therefore controlled.

TOPICS FOR HOME STUDY

1. Indicate the evidence on which our knowledge of the *reflex arc* is based.
2. What is meant by (a) the nervous impulse; (b) a simple reflex and (c) a conditioned reflex?
3. What are meant by photomechanical processes in the Vertebrate eye?
4. What is meant by the autonomic nervous system, and how can its connexions be established.
5. What are the characteristics of the Vertebrate *head*?
6. What is meant by geotaxis and phototaxis? Explain how phototactic movements are regulated in an insect.

CHAPTER IV

THE SOURCES OF ENERGY OF THE ANIMAL BODY

WHEN any change occurs in the world around us, we say that work has been done or that energy has been transformed. A living creature is always changing in one way or another. We have studied some of the characteristic forms of change which it displays and the sequence of events which constitute that extraordinary pattern of change which we call an animal's behaviour. So now we have to ask, what is the mechanism of all this transformation of energy which is called life?

Energy of the Living Machine.—The fundamental Law of Energy is the Principle of Conservation. A fixed quantity of heat is always equivalent to a given amount of mechanical work in any machine. When a machine is generating both heat and movement we can express the total energy it is giving out either in purely mechanical units or in heat units (calories). When a motor bicycle is running the total energy output (heat and movement) corresponding to a fixed petrol consumption is always the same. The difference between economical and uneconomical running of an engine lies in whether the ratio of mechanical to thermal production is higher or lower. If we run with the brakes partly on, the same amount of energy is liberated by the explosion. The difference in speed is made up by the heating of the brake linings, brake drums, etc. When the petrol of a motor bicycle gives out, the machine stops. Living matter, like a motor bicycle, is constantly doing work, often like the

motor bicycle in the form of movement from one place to another or of the emission of startling noises. From time to time the living machine has to be fed, like the petrol tank of the motor bicycle. Actually no living machines feed on petrol like motor bicycles. But the energy of the living machine depends on the chemical materials with which it is supplied as truly as the energy of the motor bicycle depends upon the petrol, benzene, paraffin, or other hydrocarbon with which it is supplied.

Living creatures, like a frog or a human being, are all subject to the same inexorable restriction. Their principal activities belong to the same two categories as those of the motor bicycle. While the motor bicycle is working, petrol is being burnt up. Motor bicycles breathe in oxygen and breathe out carbon dioxide, just as they feed on petrol. If we give a motor bicycle a full meal of petrol, let us say one gallon, and run it until it stops, in general we find that it has lost weight roughly equivalent to the weight of one gallon of petrol at the end of the run. Of course, if allowed to run inexpertly, it may become tired before the petrol has given out. Insufficient lubrication results in over-heating, or expansion of some essential fitting results in immobility. In the meantime the air around has also suffered a change, sometimes more impressive to the pedestrian than to the cyclist. If the engine is running efficiently this change consists in the disappearance of a certain quantity of oxygen and the production of a certain quantity of water vapour and carbon dioxide. If the combustion is incomplete the motor bicycle excretes soot. The rate at which a motor bicycle breathes is regulated by the air control. In all these operations nothing is lost or gained in the net result. What the bicycle loses in weight, the air gains.

The material balance sheet will show on the credit side the weight of petrol consumed and the weight of oxygen lost by the air. The debit side will include the weight of carbon dioxide and moisture gained by the air together with the weight of soot excreted. If it is difficult to empty the petrol tank, we can get the weight of the petrol consumed by weighing the machine before and after the trial period. If all the petrol put in the tank is placed on the credit side, we must add the increased weight of the machine to the debit side. The total of one side is the same as the total of the other, and the same is true of the analogous balance sheet which we can draw up for human nutrition, respiration, and excretion. On the credit side we have to reckon with food, drink, and oxygen. On the debit side we put the carbon dioxide and water excreted, together with any gain of body weight resulting from the fact that some of the food has been retained for growth. A typical balance sheet of an ordinary man weighing ten stone, when supplied with food for one day in an airtight chamber, is given by Haldane and Huxley.* On the credit side it shows:

Food	1·1 kilos (60 per cent water)
Drink	1·5 kilos
Oxygen, 500 litres or	0·7 kilo

This makes a total of 3·30 kilograms. On the debit side we have to reckon with the fact that he excretes during the same time 1·3 kilos of water and 70 grams of solids in his urine. He loses 1·1 kilos of water by evaporation from the skin as sweat. He loses 425 litres of carbon dioxide or 0·82 kilo, making in all a net loss of 3·29 kilos. The difference of 10 grams represents exactly what he has gained in body-weight at the end of the experiment. The carbon dioxide

* *Animal Biology.*

that appears is equivalent to that which would be formed by the same amount of food (allowing for what is retained for growth) if burnt in a flask.

If a human being—or a frog—is placed in a heat-proof box or calorimeter, the effect of any movements he may execute is to generate additional heat by friction with the surrounding atmosphere, and all the energy he releases will appear on the balance sheet of energy as an increase of heat in the calorimeter. When this experiment is performed, two things are found. The amount of energy expended is definitely related to the oxygen taken in and the carbon dioxide given off. In addition, the amount of energy generated during the same period is equivalent to the heat which would be generated by combustion of the quantity of food consumed if it were burnt in another calorimeter. In one experiment a corresponding balance sheet for the energy expenditure of Haldane's ten-stone man over the same period was drawn up somewhat as follows. Burnt outside the body, the same amount of food as he takes would yield 2,400 kilocalories. The total heat lost by the body during the period of experiment being 2,190 kilocalories, the difference includes a deficiency, due to incomplete oxidation of food. It can be proved from analysis of the excreta to be equivalent to 150 kilocalories, leaving only 60 kilocalories to account for. This represents the increased potential energy of the body due to stored materials which appeared in the previous balance sheet as increased weight.

Thus the two great mechanical principles called the conservation of energy and the conservation of matter both apply to all man-made contrivances and all physical phenomena. That is why it is right and proper to speak of the *living machine*. We call a dynamo, a water-mill, a steam-engine,

and a motor bicycle machines because they transform energy in accordance with certain definite rules, which are known as the laws of Energetics. We call a frog or man a living machine because it transforms one form of energy into other forms of energy in accordance with the same rules. We shall see later (p. 124) that the *oxidation* of food-stuffs is not the direct source of the energy of bodily movement. From a chemical point of view the muscle is more like a rocket than an internal combustion engine.

Chemistry of the Body.—To understand their food requirements we must bear in mind that frogs grow and reproduce their kind, and it is hence necessary to inquire into the chemical constituents of the animal body. The principal constituents of the animal body are, first, water—even man is at least 60 per cent water; secondly, dissolved in the water, certain mineral salts—notably those of sodium, calcium, potassium, and magnesium in the form of chlorides, bicarbonates, and phosphates; finally, organic matter which can be classified under three principal headings, carbohydrates, fats, and proteins. The *proteins* are the most important. They all contain carbon, hydrogen, oxygen, and nitrogen: often sulphur and phosphorus. The molecule of a simple protein may be more than a thousand times heavier than the molecule of a compound like common salt.

The protein molecule is usually regarded as built up of large numbers of amino acids. An amino acid is an organic acid in which a hydrogen atom is replaced by an NH_2 group, e.g. amino-acetic acid is $\text{CH}_2\text{NH}_2\text{COOH}$. Fischer has synthesized a compound containing eighteen amino acid groupings. Such a compound is vastly simpler than the simplest protein, but we have moved a long way from the age when, in the very same year that received Wohler's announcement

of the successful synthesis of urea, the great chemist Henry wrote (1827) concerning organic compounds:

It is not probable that we shall ever attain the power of imitating nature in these operations. For in the functions of a living plant a directing principle appears to be concerned peculiar to animated bodies and superior to and differing from the cause which has been termed Chemical affinity.

The white of a fowl's egg is almost exclusively composed of the protein, egg albumen. Gelatin is another example of a pure protein. Yet another is hæmoglobin, the red colouring matter of our blood. *Carbohydrates* contain carbon, hydrogen, and oxygen only, the last two in the same proportion as in water. The simplest carbohydrates are the simple sugars, glucose and grape sugar. More complex sugars are formed by the union of two molecules of simple sugars. Such are cane sugar (the sugar we eat), malt sugar, and the sugar contained in milk. The union of several molecules of simple sugar gives rise to much more complicated compounds of the same class, known as starch, cellulose, dextrans, etc. Potato flour is largely composed of a starch. Rice paper is largely composed of a dextrin. Cellulose, which forms a large part of the dry substance of any plant, since all plant cells are enclosed in a wall of cellulose, and lignin, the substance of woody fibres, are also highly complex members of the carbohydrate class. The *fats* also contain the same three elements alone—at least the simpler ones do; but their chemical structure is quite different. A simple fat like lard or olive oil is an ester of the trihydric alcohol glycerine and one or more of the higher fatty acids (usually acids with at least sixteen carbon atoms).

With the exception of the sugars, all these essential constituents of the organic matter of the animal or plant body

are either like the fats, quite insoluble in water, or like the proteins and starches, soluble but incapable of passing through animal or vegetable membranes (e.g. parchment) as a solution of common salt diffuses through them. Their

Food	Water, per cent	Protein, per cent	Carbo- hydrate, per cent	Fat, per cent	Calories, per lb.
Lean Beef ..	69	21·9	—	7·3	715
Breast of Chicken	74	24·6	—	0·2	466
Lean Bacon ..	56	21·5	—	5·9	649
Eggs	74	12·3	—	11·3	734
Herring ..	68	18·6	—	10·9	806
Salmon	64	18·6	—	15·8	1,012
Margarine ..	14	—	—	84·3	3,556
Butter	14	—	—	81·6	3,442
Brazil Nuts ..	2·9	13·2	8·1	70·4	3,366
Chocolate ..	1·0	4·8	59·9	31·1	2,515
Cheddar Cheese	34	25·2	—	33·4	1,939
Milk	88	3·3	4·8	3·6	303
Honey	18	0·4	71·4	—	1,290
Broad Beans ..	66	9·4	22·8	0·4	616
Brown Bread ..	44	7·5	45·8	0·1	996
Boiled Potatoes..	81	1·9	16·0	—	334
Stoned Prunes ..	28	3·0	40·4	0·3	820
Apples	84	0·3	12·5	0·2	246
Plum Jam ..	24	0·2	70·0	—	1,306
Cabbage ..	93	1·4	4·5	0·1	114

molecules are too large. So before the food eaten by an animal can get through its tissues to its destination, it must undergo certain changes. This process is known as digestion.

The Mineral Needs of the Living Machine.—In addition to the three classes of organic materials called carbohydrates, fats, and proteins the body of plants and animals contains

various mineral salts dissolved in the tissue fluids, such as the cell sap of plants, the blood, and the lymph or clear fluid in the body cavities of animals. The mineral needs of the body may be divided under two headings. First come elements which enter into the composition of the organic materials. Thus most proteins contain sulphur. Many contain phosphorus. Hæmoglobin contains iron. Hæmocyanin, the corresponding blue respiratory pigment of lobsters and snails, contains copper. The plant gets sulphur and phosphorus as it gets the nitrogen necessary to build up the protein molecule from mineral salts (sulphates or phosphates). Animals get their proteins ready made. So the supply of sulphur and phosphorus is usually adequate if the nitrogenous content of the diet is sufficient.

Magnesium is specifically necessary for the green plant because *chlorophyll* is an organic magnesium compound. In Vertebrate animals (fishes, reptiles, birds, and mammals) the thyroid gland in the neck manufactures an organic compound of which the molecule contains iodine (see p. 165). On this account iodine is essential to healthy growth. Iodine is not present in appreciable quantities in other animal tissues. For plants and Invertebrates it does not seem to be an essential element, though it is present in seaweeds. Near the sea the quantities present in salt carried by the breeze ensures a supply adequate to animal needs. Some inland and mountainous districts of Europe and America have a very low soil iodine content. Thyroid deficiency diseases (goitre, cretinism, etc.) of human beings and livestock are therefore endemic. This is remediable by a very small addition of iodine to the diet. In Switzerland the State provides iodized table salt, the necessary iodine content of which need not be greater than one-millionth of an ounce

per daily salt ration of a single person. Iodized rations are also recommended for inland hog rearing, because the pig is very liable to iodine starvation if the soil iodine content is low. The essential secretion of the thyroid gland is a crystalline compound containing 23·2 per cent carbon, 1·4 per cent hydrogen, 1·8 per cent nitrogen, and 65·4 per cent iodine.

A second class of mineral food constituents include those which appear to exist as salts in the tissue fluids and sap. These include the chlorides of several metals, notably sodium, potassium, calcium, and magnesium. Sodium does not appear to be essential to plants. Potassium, calcium, and magnesium are all essential to them. Which species flourish in different soils under similar climatic conditions is very largely affected by their relative susceptibility to a low local content of one or the other. The addition of a relatively small dressing of the appropriate salt is an important part of the technique of modern soil husbandry.

Potassium and calcium are essential to the life of all cells. This can be illustrated in a very spectacular way (Fig. 1) by perfusing the heart with a mixed solution of salts in roughly the same concentration as they occur in the blood. When a frog's heart is removed from the body it empties itself of blood, and in a few seconds stops beating. If a glass tube is inserted into the main venous orifice so that it can be supplied with a suitable solution of salts of the three essential metals, it at once begins to beat vigorously and will continue to do so for several hours. The mixture used is composed of the chlorides of sodium (6 parts per thousand by weight) and potassium and calcium ($1\frac{1}{2}$ parts per ten thousand by weight) together with a little sodium bicarbonate or phosphate to make it slightly alkaline. If the per-

fusion fluid is replaced by a mixture from which either the calcium or potassium is omitted, the heart-beat comes to a standstill. This happens almost instantaneously if no calcium is supplied. After being stopped in this way, the beat resumes almost at once when the heart is supplied with the original mixture. If the solution contains a little sugar the isolated heart can be made to beat for several weeks. Otherwise it gradually uses up its food reserves, and then ceases to be able to work. The same results can be obtained with the sheep's heart, which can also be made to go on working outside the body for at least three weeks, provided the temperature of the fluid is kept near blood heat, i.e. about 36° C. For prolonged experiments of this kind a trace of magnesium is necessary. Lately it has been shown that small traces of manganese may be essential to fertility in mammals. It is not yet known how it is used. Manganese is also necessary to many plants.

Animals are not liable to magnesium deficiency since all green plants contain an abundance of magnesium for their needs. On the other hand, plants which grow on soils with a low lime content may contain a relatively small amount of calcium. Hence herbivorous animals like the pig, which is highly susceptible to calcium deficiency, are liable to various diseases (especially rickets) unless lime fertilizers are applied to the soil or an extra calcium ration is given. The figure already cited with reference to iodine illustrates the general principle that a soil deficiency which might completely exclude the possibility of successful livestock husbandry can often be remedied at a negligible cost. The provision of suitable mineral rations or soil dressings is one way in which advancing biological knowledge is making it possible to break down the natural limitations of locality.

Vitamins.—In the first decade of the present century the chemistry of foodstuffs had progressed so far that it was possible to carry out more exact observations by feeding animals on diets of chemically pure protein, fat, and carbohydrate. The animals reared on such diets refused to grow, though they thrived if comparatively small traces of natural foods were added. Further research showed that different symptoms of disorders produced by exclusive feeding on such purified rations could be eliminated by the addition of small quantities of ordinary articles of food. So it has been possible to distinguish different “accessory food factors,” the absence of any one of which is associated with a particular defect.

Generically these substances have been called vitamins. The name does not mean that they have anything in common besides the fact that they do not belong to the classes of diet constituents previously believed to be all-inclusive, the fact that the requisite quantities are very small, that they all appear to be organic compounds, and that their chemical constitution was unknown when the word was first introduced. The chemical constitution of several of them is now known, some can be synthesized, and others will be synthesized in the near future. Research along these lines was encouraged by the conditions of food shortage during the European war of 1914–18 when “nutritional” diseases like scurvy and rickets came into prominence.

Scurvy is due to the absence of a comparatively simple substance in the diet. It is *ascorbic acid*. Before its chemical nature had been determined it was called “vitamin C.” Ascorbic acid has the formula $C_6H_8O_6$. It has alcoholic and ketone characteristics on account of four OH and one CO radicle in the molecule. It is present in most fresh fruit and

in many vegetables, especially in oranges, lemons, black currants, green leaves, and potatoes. Since its molecular constitution has been discovered, its commercial manufacture from glucose has been started.

Calciferol, with the formula $C_{28}H_{43}OH$, is one of the known forms of another vitamin, "D." It is produced by the action of ultra-violet light on another alcohol called *ergosterol*. Ergosterol has the same formula $C_{28}H_{43}OH$ with a different internal arrangement of the atoms in its molecule. The exact chemical constitution of both substances is now known. Various fish liver oils contain another form of vitamin D whose formula is $C_{27}H_{41}OH$. So also does butter fat. The D content of the husks of ripe cocoa beans is high, and the latter can be used in cattle feeding to raise the D content of the milk. The absence of D is responsible for the deficiency disease called rickets, still common among the poorer section of the population. Rickets can be cured and, of course, prevented by administering any form of vitamin D, or by exposure to ultra-violet radiation from intense sunlight or a mercury vapour lamp. The exposure leads to the production of D in the skin from pro-vitamins such as ergosterol. Rickets is a deficiency disease affecting especially bone and tooth development in children. They are especially prone to it if brought up in dingy dwellings and sunless cities, unless the lack of ultra-violet light in their normal environment is counterbalanced by a diet containing excess of D, that is to say a diet with plenty of fresh eggs, summer milk, butter with, preferably to make sure, some fish liver oil or calciferol preparation. Pigs are also liable to get rickets. Modern pig-breeders take special precautions to avoid this. In Scandinavian countries glass which transmits ultra-violet light is used for the windows of pig-styes. There has been more

progress in the education of Danish pig-breeders than in the education of British politicians.

Scurvy and rickets are the chief diet "deficiency" diseases which have attracted attention in the West. There are several others. Apparently the animal body needs a substance which is abundant in the husk but not in the grain of plant seeds like cereals. Its absence produces severe muscular weakness, especially in birds. A similar condition in human beings is the disease called "beri-beri" to which Japanese peasants who live largely on a diet of polished rice are liable. This is because removal of the husk removes "vitamin B₁." Beri-beri can be cured by the administration of suitable extracts made from these husks, from wheat germ, or from yeast. The active chemical constituent is apparently an unusual type of organic compound with the provisional formula C₁₂H₁₇O N₄S . Cl. To keep animals healthy on diets of pure proteins, fats, carbohydrates, and mineral salts it is essential to add various other substances like the above in minute quantities. One of these, called vitamin A, is present along with D in butter fat, egg yolk, and cod-liver oil, especially in the first two. It is also an alcohol with the formula C₂₀H₂₉OH, chemically related to the plant pigment *carotin*. The animal body can convert the latter into A. If the diet is deficient in A, or in carotin, its pro-vitamin, animals show general liability to bacterial infections, and an adequate minimum seems to help resistance to diseases like colds and influenza. Another, called vitamin B₂, has a rather similar distribution to B₁, and was at first confused with it. Deficiency of one of the B vitamins is responsible for *pellagra*, a disease of the digestive system and skin. The composition of what is now called vitamin E, present in cereal oils and green leaves, especially lettuce, is not yet known. If it is absent complete

sterility results from degeneration of the testes in the male and resorption of early embryos in the female.

A supply of fresh butter and green vegetables or fresh eggs ensures the presence of sufficient vitamins to meet the requirements of healthy growth. A liberal allowance of milk keeps up an adequate supply of calcium and of B₂. If the

VITAMIN RESOURCES OF COMMON FOOD

Food	A	B ₁	B ₂	C	D
Lettuce	++	++	+	+++	o
Tomatoes	+	+	+	++	
Lean Meat	o	o	+++	o	o
Herring	o	o	++	o	+
Eggs	++	++	++	o	++
Cheddar Cheese ..	+	o	++	o	+
Butter	+	o	o	o	+
Milk	+	o	+	+	+
Dried Peas, Beans and Lentils	o	+++	+	o	o
Potatoes	o	+	o	+	o

mineral and vitamin content of a diet are safeguarded by this means, or by recourse to the use of pure chemicals such as calciferol or carotin, a diet of soya beans can supply all that is necessary for the physical requirements of a human being. While wheat, barley, and rice appear to be adequate as sources of proteins, maize is not. The reason for this is that digestion of maize protein does not yield one of the amino acids (tryptophane), which is an essential constituent of proteins in the animal body.

Plant and Animal Nutrition.—A few plants (e.g. duckweed) have almost lost the power of sexual reproduction

and propagate mainly by the vegetative method, and a few plants and animals (e.g. the parasitic maggot of the horse-fly) do not use oxygen to burn up waste materials. Apart from such isolated exceptions it is correct to say that two processes are common to *animals and plants*. One is sexual *reproduction*. The other is *respiration* or the oxidation of organic material with the production of carbon dioxide and water.

The most obvious differences between animals and plants are characteristics of behaviour. Animals have a greater range and scope of reversible responses than plants; and more specialized sensitivity to changes in their surroundings. Plants have greater power of rapid and sustained growth than animals. A striking structural difference between the tissues of animals and plants is that animal cells are naked and plant cells have an inert *cell wall* nearly always composed of *cellulose*. These differences are associated with others which are less obvious but equally significant. All animals are dependent on food containing complex organic substances. The animal cannot synthesize amino-acids, fats, or carbohydrates from simpler organic compounds. It has to get them by eating other living things or by living *saprophytically*, i.e. on decaying organic matter. The green plant needs only carbon dioxide, water, and simple mineral constituents of the soil such as nitrates, phosphates, and sulphates to build all the complex organic compounds which are essential constituents of living matter. Energy is necessary to make complex organic compounds which give up energy when they are broken down into simpler ones, and the green plant absorbs this energy from sunlight by means of the assimilatory pigment *chlorophyll*. This leads to the formation of sugar from carbon dioxide and water with the liberation of oxygen.

Even plants, such as the mushroom or the dodder, which have taken to a saprophytic or parasitic habit and have lost their chlorophyll, are able to synthesize proteins if they are supplied with sugar and nitrates. The ability of plant cells to synthesize any *essential* amino-acid molecule and the inability of the animal body to do so is therefore a fundamental difference between animals and plants. There are certain other differences between the chemical processes which occur in plant and animal cells, as, for instance, the fact that although some animals can synthesize vitamins A, C, and D, no animals are yet known to be able to synthesize B₁, B₂, or E, as plants can.

TOPICS FOR HOME STUDY

1. Discuss what is meant by the living machine.
2. Tabulate the differences between animals and plants from the standpoint of structure, mechanism, and reproduction.

CHAPTER V

DIGESTION, RESPIRATION AND EXCRETION

WE have now seen from what sources the animal body replenishes its stores of potential energy and obtains the raw materials essential for growth and repair of tissue waste. Our next task will be to examine how the food is made available to the cellular engines of the body, and how the products of combustion are removed.

Digestion.—Frogs feed on worms, insects, and the like. These, like our own food and that of all animals, contain all three classes of essential organic compounds the body requires for growth and activity. It may be asked, where do these come from in the first place? Those animals that do not feed on other animals are vegetarians; and plants possess a peculiarity of nutrition that animals do not. They can build up carbohydrates from the carbon dioxide and water of their environment and build up proteins as well. Since these are the things which supply chemical energy to the living machine, it may be asked, whence comes all the energy required to build up these stores of chemical energy? The answer is that plant tissues absorb light by means of the green colouring matter, chlorophyll, of the stem and leaves: only in the day-time can they build up starch. The ultimate source of the energy of life on this planet is therefore the radiant energy of the sun.

From the mouth the food of man or of any other Vertebrate animal passes into a winding tube which terminates in a second opening to the exterior, the *anus*, situated dorsally where the legs are joined to the body. This tube,

known as the *alimentary canal*, or gut (Fig. 43), has everywhere muscular walls, an inner layer of muscle fibres arranged circle-wise, and an outer coat with a lengthwise arrangement. The slow, rhythmical movements of these muscles help to churn the food, and squeeze it along the alimentary canal to the anus. The inner wall of the gut is

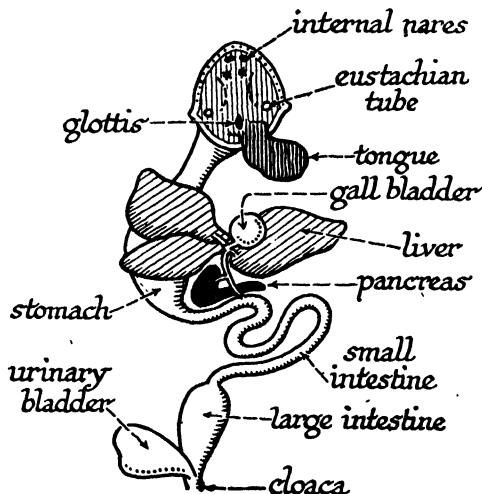

FIG. 43—ALIMENTARY CANAL AND ASSOCIATED STRUCTURES IN THE FROG

lined with a layer of cells which for a great part of its course consists of secreting cells and is folded in pits. The first part of the tube, which in our own case is called the *œsophagus*, or gullet, opens into a capacious bag. This bag, the stomach, leads into a narrower tube, the intestine. The intestine of Vertebrates has two distinct portions, one narrower, called the *small intestine*, and the other wider, called the *large intestine*. Its final part, the *rectum*, communicates with the exterior by the anus (Fig. 44).

In its passage along the alimentary canal human food

encounters the various juices secreted by different parts of the walls of the digestive tract, and also the secretions of two larger glands, the liver and pancreas, which open by a

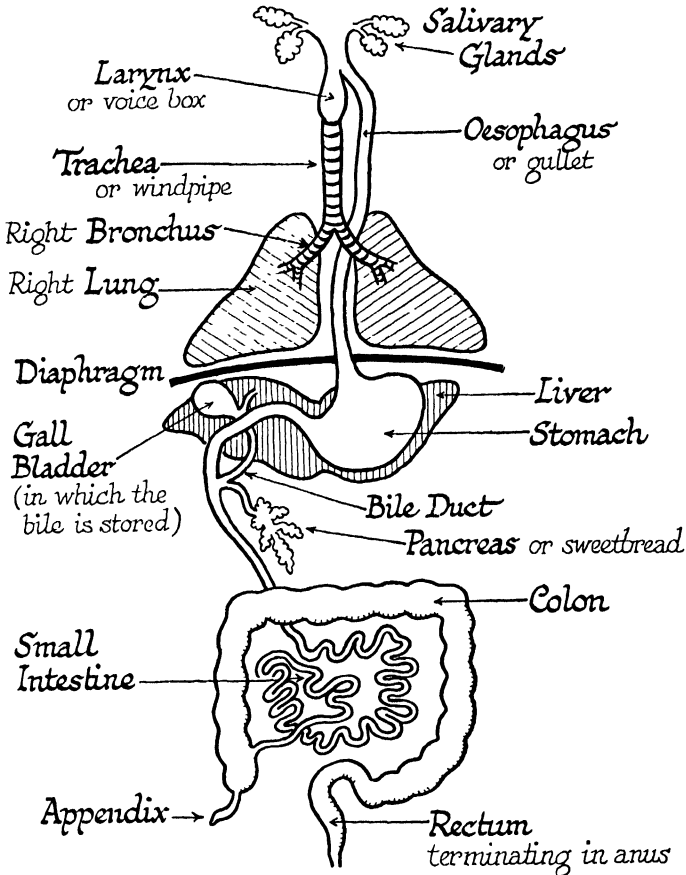

FIG. 44—THE ALIMENTARY CANAL, ITS ASSOCIATED STRUCTURES, AND THE LUNGS IN MAN

In this, and all similar figures, the organs are seen in ventral view (i.e. from the front, in man), so that the organs of the right side appear on the left of the diagram and vice versa. As drawn, the liver is tucked under the stomach.

common duct into the small intestine near its anterior end. These digestive juices contain substances known as *enzymes* which act on the complex organic constituents of the food, turning them into compounds sufficiently simple to diffuse through the walls of the intestine or sufficiently simple for the cells of the body to build them up into other substances as these may be required.

Enzyme Action.—Chemical reactions may be divided into two categories. One includes all such as are involved in ordinary methods of volumetric analysis, where the combination of reacting substances is practically instantaneous, as, for instance, the neutralization of hydrochloric acid with soda or the precipitation of barium sulphate from a soluble barium compound in the presence of free SO_4 ions. The other includes most organic reactions, such as the saponification of esters or the inversion of cane sugar, in which an appreciable period of time must elapse before the point of equilibrium is reached. The reactions with which the biologist is concerned belong pre-eminently to the latter class. Many reactions such as the combination of pure oxygen and hydrogen ordinarily proceed at an immeasurably slow rate, but can be induced to take place within ordinary time limits in the presence of certain substances (in this case, e.g., finely divided platinum), which do not appear to have undergone any change whatsoever at the conclusion of the experiment. For such bodies as are capable of influencing the velocity of a chemical reaction without entering into the composition of the end products, or, in general, shifting the point of equilibrium for a given set of conditions, the term *catalyst* is commonly employed. The facility and rapidity with which the organism is enabled to disintegrate highly stable compounds, such as proteins, is due to the

agency of a special type of catalyst known as *enzymes*, of which a culinary example familiar to most of us is the *rennin* of the gastric juice.

The term *enzyme* was introduced by Kuhne (1878) to remove the confusion resulting from the use of the older term "ferment," a term originally used to include microorganisms like the yeast fungus. This confusion was finally dissipated when Buchner (1903) extracted from crushed yeast cells an "unorganized" ferment capable of effecting the identical transformation hitherto associated with the activities of the living organism.

Apart from the fact that they are all derived from living organisms, it is difficult to fix on any single characteristic which will differentiate enzymes from all other types of catalysts. At present their chemical constitution is unknown. What may be described as the general catalytic properties of enzymes may be classified under three headings, the reversibility of their action, their efficacy in very small quantities, and the independence of the amount present to the final result. Of these the first is of special importance to the understanding of the chemical balance of the body, or, to use the term usually employed for the chemical processes of the organism as a whole, *metabolism*.

A straightforward illustration of what is implied by the term reversibility of reaction is provided by the preparation of ethyl acetate, which was the subject of the historic researches of Berthelot and Pean de Saint Gilles (1862) on mass action. If equal amounts of molar solutions of acetic acid and ethyl alcohol are brought into contact an equilibrium point is reached when the molecular concentration of the reacting compounds is reduced by two-thirds owing to the formation of ethyl acetate. Precisely the same point of equi-

brium is reached when a molar solution of ethyl acetate is subjected to acid hydrolysis, i.e. broken down by the catalytic action of a mineral acid. It is usual to think of both reactions as taking place continuously and simultaneously with different velocities except at the point of equilibrium concentration for the reacting substances. The catalyst, in this case an acid, acts by accelerating the reaction in either direction, and the equilibrium point for the same conditions of concentration etc., is unchanged, so that the total energy of the system is unaltered.

Theoretically any reaction may be regarded as reversible. In their efficacy to accelerate the velocity of reaction in either direction, enzymes conform to the behaviour of other catalysts. The first demonstration of this was due to Croft Hill (1898) who studied the hydrolysis of the disaccharide malt sugar under the influence of the enzyme *maltase*. Malt sugar is split by this enzyme into the simpler sugar *d-glucose* (a monosaccharide). Hill showed that when maltase is added to glucose, malt sugar is formed, and the equilibrium point is reached at the same relative concentration of the two sugars as in the reverse reaction for identical conditions. Needless to say, any reversible reaction may proceed to completion either way by the continuous removal of one of the end products by means either mechanical (e.g. diffusion), or chemical (e.g. precipitation). Hill's discovery makes it possible to envisage how, for example, the balance of sugar in the body and glycogen in the liver and muscles is continuously maintained throughout life, or how, to take a second illustration, the tissues store up fat when the diet is plentiful, while in times of shortage fat disappears from them.

In true catalysis the final result of a reaction is not determined by the quantity of the catalyst present. Like in-

organic catalysts an enzyme can often be reclaimed at the end of a reaction and made to react on a fresh supply of material. This is not always so. Enzymes are highly unstable bodies, being readily destroyed, like many other colloidal systems, by heat. Surprisingly small quantities of enzyme are efficacious. Rennet, the gastric juice extract employed domestically for the preparation of junkets and commercially on a large scale in the manufacture of cheese, is able to clot 400,000 times its own weight of the milk protein *caseinogen*. Even this figure gives an imperfect picture of the prodigious activity of the enzyme. The active constituent is very small in proportion to the bulk of the extract.

Digestive Enzymes.—The secretion of the stomach or *gastric juice* contains free hydrochloric acid. It also contains an enzyme *pepsin* which breaks down complex proteins, like albumen, into very simple proteins that are called peptones. It has no action on the starchy or fatty constituents of the food. The bile or secretion of the liver does not contain a digestive enzyme. It contains excretory matter in the form of certain pigments together with alkaline salts which neutralize the acidity of the gastric juice, and greatly facilitate the emulsification of fats.

The pancreas or sweetbread is the chief digestive gland. Its secretion contains three important enzymes. One called *amylase* breaks down starch or dextrin into malt sugar. A second called *trypsin* can break down proteins into the organic "amino" acids of which the protein molecule is built up. It thus carries protein digestion a stage farther than that reached in the stomach. A third called *lipase* breaks up fat into fatty acid and glycerol. The intestinal juice secreted by the glandular walls of the small intestine also contains enzymes, one called *erepsin*, which acts on the final stages of

protein decomposition, completing the work of the pancreatic juice, and a series of others which act on the complex sugars like malt sugar, converting them into simple sugars. Man possesses three pairs of *salivary* glands whose ducts open into the mouth. Our saliva contains an enzyme which in comparatively alkaline and neutral solution acts like the pancreatic amylase on starch. It cannot act in the acid medium of the stomach contents, and vigorous mastication, while probably an admirable means of preserving the teeth, has no justification on the grounds of facilitating starch digestion to any considerable extent. The digestive tract of man does not contain any enzyme that breaks down cellulose. Some cellulose is broken down by bacteria in the large intestine, and is wasted. This is a very strong argument against an exclusively vegetarian diet. Another objection to vegetarianism is that the cellulose wall of plant cells makes them much less accessible to the action of the digestive juices than animal tissues. The chief value of vegetable food lies in the fact that it can be eaten raw as a supply of certain constituents of a normal diet, the so-called vitamins, which are requisite in extremely minute quantities and have not as yet been identified chemically. The vitamin content of food is diminished by prolonged cooking.

Any undigested or indigestible matter eventually passes out of the body, along with the bile pigments that confer its characteristic colour, as *fæces*. In the small intestine the starches have all been absorbed as sugar by the fine blood vessels beneath its lining. The proteins have been broken down into the diffusible substances known as amino-acids and travel to the tissues by the same route. All the blood returning from the alimentary tract passes through the capillary network of the liver *en route* for the heart. The

glycogen-storing activity of the liver is its most important role in the economy of the body. The products of fat digestion on the other hand are taken up by the cells of the lining of the small intestine, and given up in turn to the underlying tissue spaces. The ensuing stage in the history of the food-stuffs, therefore, belongs to the subject matter of our next

TABLE OF DIGESTIVE JUICES OF A MAMMAL

Digestive Juice	Constituents	Action
Saliva ..	Ptyalin	Starch to malt-sugar
Gastric juice (mucosa of stomach)	{ (a) Rennin	Clots milk protein
	{ (b) Pepsin }	Proteins to <i>peptones</i>
	{ (c) HCl }	
Bile (liver) ..	{ (a) Bile pigments	Nil
	{ (b) Bile salts	Emulsify <i>fats</i> and neu- tralize gastric juice
Pancreatic juice	{ (a) Trypsin	Peptones to <i>polypeptides</i>
	{ (b) Steapsin	<i>Fats</i> hydrolyzed
	{ (c) Amylase	Same as ptyalin
Intestinal (mu- cosa of small intestine)	{ (a) Enterokinase	Activates <i>trypsin</i>
	{ (b) Erepsin	Polypeptides to <i>amino-acids</i>
	{ (c) Maltase	Malt sugar to <i>dextrose</i>
	{ (d) Invertase	Cane sugar to <i>dextrose</i> and <i>levulose</i>
	{ (e) Lactase	Milk sugar to <i>dextrose</i> and <i>galactose</i>

chapter on the circulation of the blood (see p. 134 and Fig. 54*a*). But first let us look at the other end of the story, the burning up of the final products of all the chemical activity that goes on in the body, and the removal of waste substances.

Respiration.—Like ourselves, the frog takes in oxygen

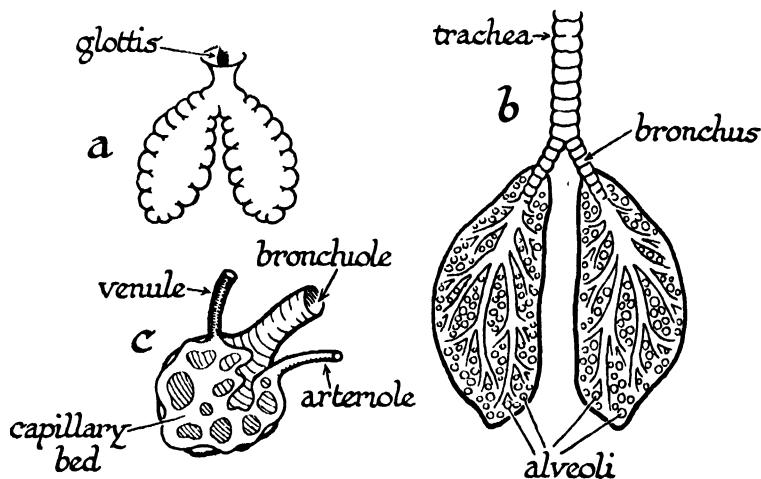

FIG. 45—RESPIRATORY ORGANS OF FROG AND MAN

a, lungs of frog. *b*, lungs of Man. *c*, single air sac or alveolus from human lung.

from its surroundings and gives up carbon dioxide. All parts of the body utilize oxygen in this way, but in ourselves oxygen enters the body by one route and one route only, namely the lungs. These are spongy sacs well supplied with blood vessels, the walls of their pores being very thin, and all its minute cavities, or alveoli, communicating with a tube—the *bronchus*—which joins its fellow of the other lung to form the organ known as the *trachea* or windpipe. Air is sucked through the nasal passage or mouth into the

windpipe at the back of the throat by the suction of a broad sheet of muscle, the diaphragm, beneath the lungs and above the stomach. In the frog absorption of oxygen and elimination of carbon dioxide also takes place all over the surface of the body through the moist skin. The lungs are less spongy than ours are and have relatively fewer compartments. The two lungs open together by a longitudinal slit, the glottis, at the back of the throat. The frog breathes by swallowing air. It has no diaphragm.

In the frog the main use of food is to supply chemical materials for the activities of the organs, e.g. glycogen or animal starch for the muscles, and materials for growing tissues. The frog is much less capable of surviving cold than we are. Man is a warm-blooded animal and maintains a temperature higher than that of his surroundings by the oxidation of foodstuffs. Man requires relatively more food than the frog for this reason. Though oxygen is essential for sustained muscular activity, the energy of muscular activity does not come from the oxidation of materials in the muscles. Muscles will contract in the absence of oxygen. The energy of muscular movement comes from the explosive breakdown of an organic phosphorus compound. This reaction is accompanied by the formation of lactic acid. If lactic acid accumulates, fatigue ensues. By burning up the lactic acid into carbon dioxide and water vapour, a constant supply of oxygen makes possible the removal of the fatigue products. In the efficient activity of an animal, non-volatile products of muscular work are burnt up as soon as they are formed. For this reason muscular exercise is quantitatively related to oxygen consumption in the normal course of events, and it has been customary in the past to regard the oxidation of the foodstuffs as the source of muscular energy. Strictly speak-

ing, this conclusion is incorrect. It is none the less true that the disappearance of a fixed amount of oxygen is ordinarily associated with a given amount of muscular activity in the balance sheet of the living machine.

Excretion.—Movement in the frog is the main form of bodily activity, and as muscle uses carbohydrate (glycogen)

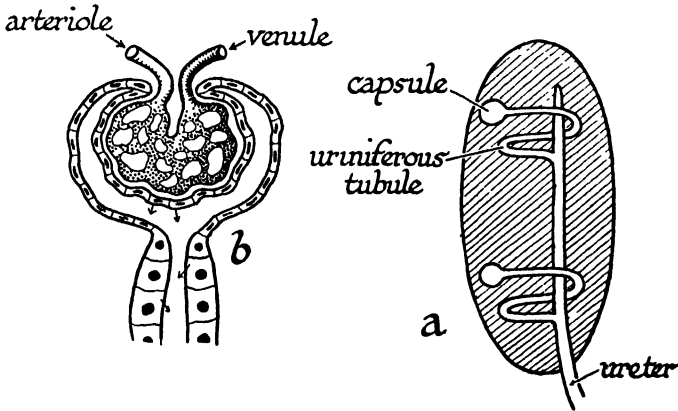

FIG. 46—ON THE RIGHT, VERY DIAGRAMMATIC REPRESENTATION OF THE KIDNEY OF THE FROG WITH TWO OF THE TUBULES SHOWN DISPROPORTIONATELY ENLARGED. ON THE LEFT, THE CAPSULAR END OF A SINGLE TUBULE, HIGHLY MAGNIFIED

as its source of energy, it follows that in a full-grown animal most of the nitrogenous material of the food is waste matter. The body can convert the products of protein digestion into carbohydrates by removal of the nitrogenous portion in the form of simpler nitrogen compounds such as urea $\text{CO}(\text{NH}_2)_2$. These are eliminated from the body in the urine. The urine is produced by two organs known as the kidneys which communicate with the cloaca by tubes known as the *ureters*. Each kidney is a flattened ellipsoidal structure with a small cavity continuous with the canal of the ureter. Into this cavity open innumerable closely packed tubules of glandular

structure which make up the substance of the kidney. These tubules terminate in a flask-shaped swelling whose walls are invaginated to receive a tuft of small blood vessels, this portion being called the Malpighian body, or capsule, after Malpighi (1628-94), one of the earliest microscopists. The structure of our own kidney is essentially like that of the frog in this respect, but in man the ureters open into a capacious receptacle with muscular walls, the bladder. This communicates with the exterior by a duct called the *urethra*, separately in the female and along with the male generative ducts in the male.

History of Digestion and Respiration.—We have said nothing so far about the history of metabolism. The chemistry of the animal body could not be studied at all until comparatively recent times, and in point of fact the applicability of the two great scientific generalizations known as the indestructibility of matter and the conservation of energy were applied to animals almost as soon as they were recognized to hold good in the world of dead matter. Towards the end of the eighteenth century the ingenious Abbot Spallanzani made observations on the digestion of meat in the stomach by making dogs swallow pieces of meat attached to string, and withdrawing them at intervals. He also showed that the gastric juice would perform the same action outside the body. Under the influence of Liebig and others in the first half of the nineteenth century, the foundations of modern knowledge about digestion had been laid down.

The experiments of Robert Hooke with his air pump first showed the necessity of air to animal life. Hooke also showed that only a part of the air was so essential. The history of the study of respiration is closely bound up with the discovery of oxygen, nitrogen, hydrogen, and carbonic acid gas.

Black, the discoverer of carbon dioxide, and Priestley were both intensely interested in the problem of respiration. Two

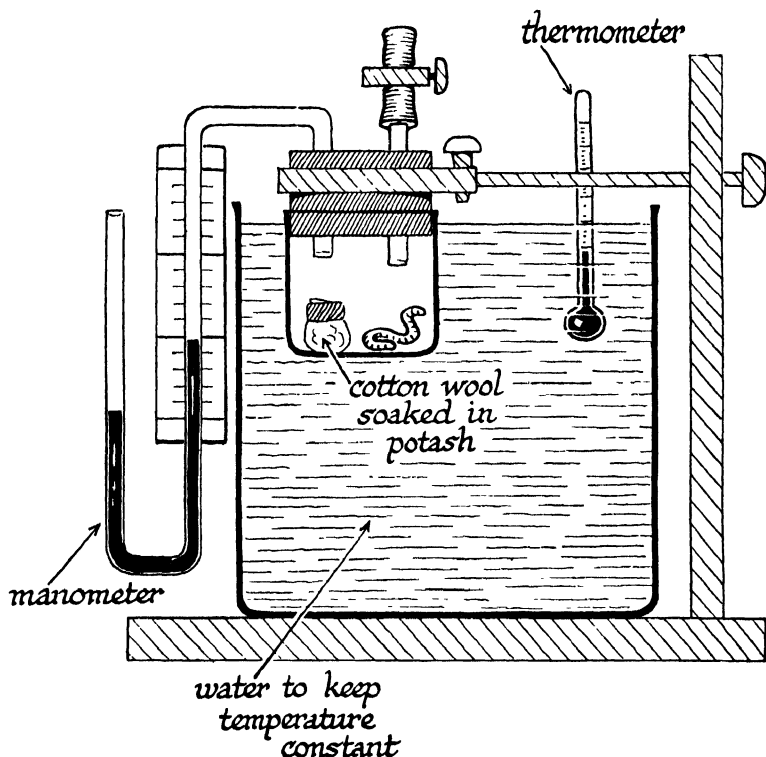

FIG. 47—APPARATUS FOR MEASURING THE OXYGEN CONSUMPTION OF A WORM OR OTHER SMALL ORGANISM

The carbon dioxide produced by the organism is absorbed by the potash, and the change in the pressure recorded by the manometer is therefore due to the oxygen consumed. The instrument can be calibrated so that the actual volume of oxygen taken in can be determined.

years after his epoch-making work on the calcination of metals, Lavoisier published (1777) the first of a series of memoirs on animal respiration, recognizing at the outset the essential fact that the carbon dioxide exhaled from the

lungs was the product of an oxidation process, in which the source of oxygen was the atmosphere. In 1780, in collaboration with the great mathematician Laplace, Lavoisier published a memoir on animal heat, showing by direct physical measurement with the balance and the thermometer that the warmth of our bodies is a process of combustion of a kind essentially like that of the candle flame. After the discovery of hydrogen by Cavendish, Lavoisier discovered that water vapour as well as carbon dioxide arises from the oxidation processes of the body. In 1803 Spallanzani published a memoir recording large numbers of experiments on a variety of animals (Vertebrate and Invertebrate) showing that the phenomena of respiration are universal properties of the animal economy, and that the seat of the respiratory processes is the tissues themselves.

TOPICS FOR HOME STUDY

1. Compare the method of breathing in Man, the Frog, and a bird (refer to Rogers (1938), *Textbook of Comparative Physiology* (McGraw-Hill); Barcroft (1928), *Respiratory Function of the Blood* (Cambridge); Krogh, *Respiratory Exchange of Animals and Man: Monographs on Biochemistry*).
2. Describe the structure of the Vertebrate Kidney and the functions of its parts.
3. Describe the digestion of fats, carbohydrates, and proteins in the animal body.

CHAPTER VI

THE TRANSPORT OF MATERIALS IN THE ANIMAL BODY

OUR last task was to inquire into the sources of energy of the animal body. We saw how chemical materials containing a rich supply of stored energy are taken into the body, and how oxygen supplies the body with heat and burns up the end-products of muscular activity. We have still to learn about how the digested food materials are carried to the tissues from the walls of the gut, how oxygen is transported from the lungs to the tissues, and how carbon dioxide is transported from the tissues to the lungs. So we now come to a consideration of the circulation of the blood.

If we examine the translucent skin between the toes of the frog we find that it is threaded with a network of fine tubes, through which the blood is visibly moving. Through this network we are able to see that the blood flows in *one* direction, and we can easily observe that the finer vessels are formed by the repeated division of larger vessels and that in their turn these unite together to form other vessels which are also larger. The smallest vessels of the network are called *capillaries*. A network of similar vessels is found in all parts of the body. Capillaries unite together to form larger vessels with muscular walls called *veins*, which have little valves in their course, rather like watch pockets (Fig. 48). If we trace the smaller veins of any organ forward in the direction in which the blood is moving we come, sooner or later, to the large muscular pumping organ known as the heart. From the heart spring vessels thicker than the veins

and without valves, except at the point where they leave the heart itself. These are called *arteries*. These arteries branch repeatedly, and eventually their terminal branches are continuous with the capillary network of the various tissues of the body. Thus the blood flows in a closed circuit, from the

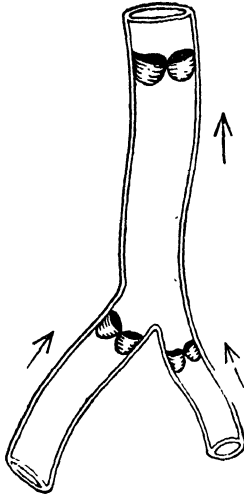

FIG. 48—DIAGRAM OF VEIN SHOWING VALVES

The arrows represent normal direction of the flow of blood.

heart *via* the arteries to the capillary network of the tissues, and from the capillary network of the tissues by way of the veins back to the heart itself.

The fact that the blood of man and of animals generally, if they possess a circulatory system, flows in a closed circuit was not fully grasped before the work of Harvey in the seventeenth century (1628), though some earlier anatomists, including Servetus, who was burned at the stake at the instigation of Calvin, had come very near to a clear realization of the fact. Until the invention of the microscope, it was impossible to see the finer vessels. The circulation was first

observed directly in the manner indicated above by the pioneer microscopists Malpighi (1661) and Leeuwenhoek (1668).

The Blood.—Blood is not a homogeneous fluid, but a suspension of densely packed cells. Some of these are ovoid discs charged with a colouring material which in thin layers is yellowish, but seen in greater concentration appears red. This colouring matter which gives to blood its characteristic hue is known as *hæmoglobin*. A solution of hæmoglobin is normally of a bright scarlet hue, like that of the blood in our arteries. When shaken in a vacuum or in pure nitrogen or hydrogen it changes colour, as was first shown by Priestley (1774). It assumes the purple hue of the blood flowing in the veins. Priestley also succeeded in showing that oxygen, or, as he called it, dephlogisticated air, was the constituent of the atmosphere with which purple, or reduced hæmoglobin combines. The presence of hæmoglobin is thus a fact of immense importance. Owing to its power to combine loosely with oxygen, the amount of oxygen that blood can take up is considerably higher than the amount which dissolves in a corresponding quantity of water. Thus 100 c.c. of our own blood will take up 18·5 c.c. of oxygen in air at atmospheric pressure, whereas 100 c.c. of water would absorb only 0·7 c.c.

The movement of the blood in the vessels ensures a constant supply of food materials and oxygen to the tissues, and a constant draining away of waste products which diffuse through the thin walls of the capillaries. The oxygen-carrying property of the blood is specially important. All tissues store food materials, just as the muscle stores glycogen or animal starch. But the storage capacity of the cells of the body for oxygen is very small, and oxygen is constantly being used. Insects which have a peculiar system of minute

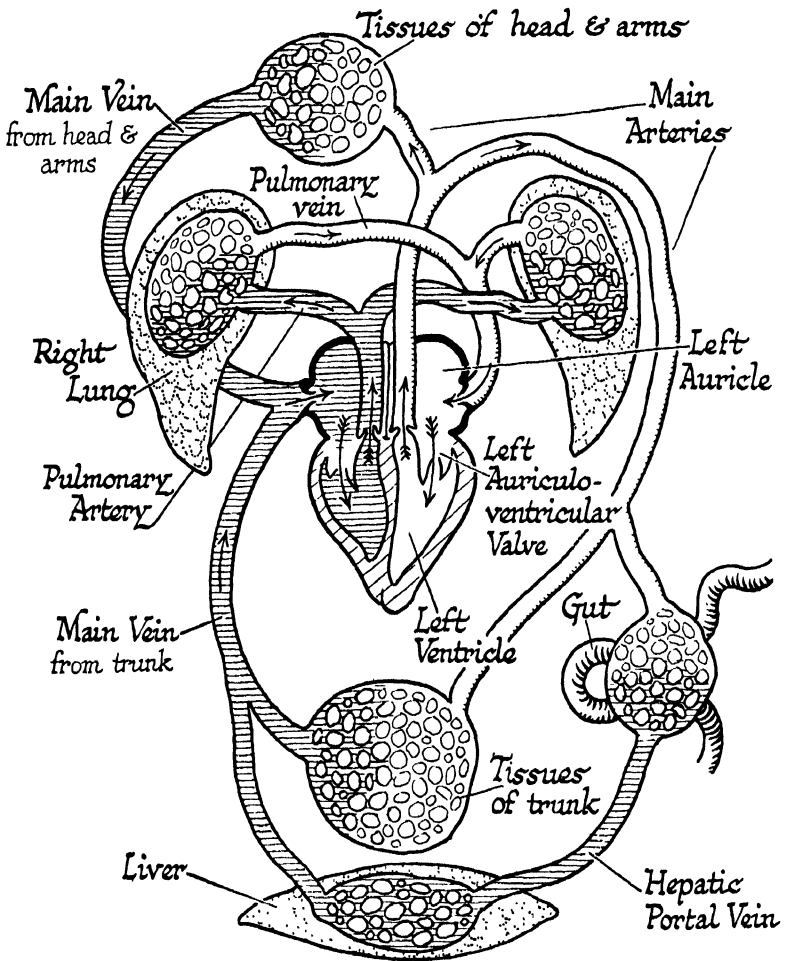

FIG. 49—DIAGRAM OF MAIN PATHS IN THE HUMAN BLOOD SYSTEM

The smaller arteries connected with the smaller veins by the fine network of capillaries penetrating all the tissues are collectively represented by six spongy masses. Blood comes back from the head and arms, the trunk and legs and from the liver by two main veins which discharge into the thin-walled right auricle. When this contracts, the blood is forced into the right ventricle, till the latter, being filled, is closed by the right auriculo-ventricular valve. The contraction of the right ventricle forces the blood into the pulmonary artery from which it cannot flow back, because of the

[Continued at foot of page 133

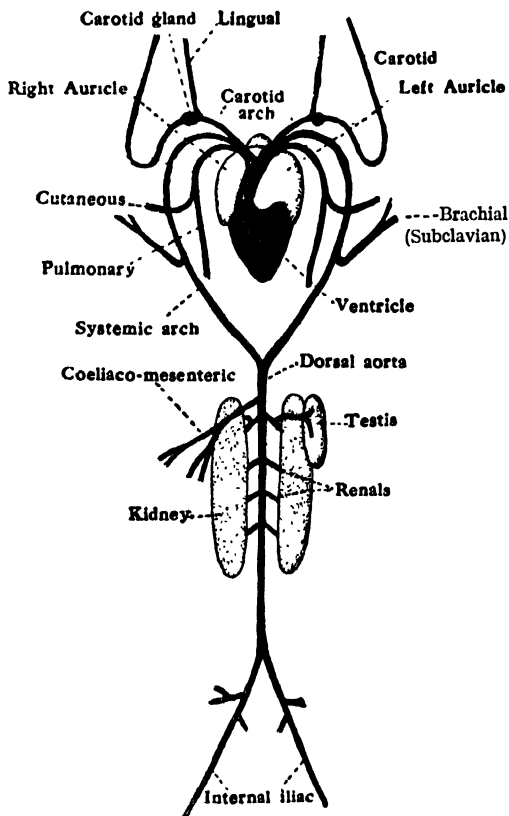

FIG. 50—PRINCIPAL ARTERIES OF THE FROG

Continued from page 132]
 valves placed at its base. Replenished with oxygen in the lungs, the blood returns to the left auricle by the pulmonary vein. It is then discharged into the left ventricle, then by the main artery or aorta to the organs of the body other than the lungs. The blood from the gut or alimentary canal does not flow back directly to the main vein (post-caval or inferior vena cava) of the trunk. It is collected by a large vein, the hepatic portal, which branches like an artery, discharging its blood through the capillary bed of the liver (see p. 134), so that all the blood carrying absorbed foodstuffs from the intestine has to pass through the liver before it gets into the general circulation. If you have any difficulty in remembering the right and left orientation of the circulation the following mnemonic will help: LIFE-GIVING BLOOD LEAVES LUNGS FOR LEFT AURICLE. REDUCED BLOOD RECEIVED BY RIGHT AURICLE FROM REST OF BODY.

tubes (tracheæ) bringing air directly into contact with the tissues can get on perfectly well without a well-developed circulatory system, though many insects surpass all animals except birds in their incessant muscular activity. Hæmoglobin occurs in the blood of all the great groups known as Vertebrates (fishes, frogs, lizards, birds, man, etc.) and in most of the worms. The blood of snails, lobsters, squids, and a few other animals contains another respiratory pigment, known as *hæmocyanin*, which is blue in the presence of oxygen, and becomes colourless when shaken in a vacuum. Hæmocyanin, like hæmoglobin, is a protein combined with a metal. The metallic constituent of hæmoglobin is iron, that of hæmocyanin is copper. Hence the importance of traces of iron in our own food.

The Circulatory System of the Frog.—A convenient starting place to take in considering the circulation is the capillary network of the digestive tract. The small veins of the intestine unite into larger ones which eventually merge into the vessel known as the *hepatic portal vein*. This vein does not unite with other veins directly, but branches in the substance of the liver into smaller veins which are continuous with the capillary network of that organ. The liver is a great storehouse of carbohydrate in the animal body. It stores carbohydrate in the form of the animal starch known as glycogen. The blood coming from the capillaries of the intestine after a meal is ordinarily rich in sugar. In the liver the excess of sugar is built up into glycogen. The glycogen of the liver is transformed into sugar, as the supply of glycogen in the muscles is used up. The work of Claude Bernard in 1857 first showed that the blood in the hepatic portal vein after a meal is richer in sugar than the rest of the circulation, and that the store of glycogen in the liver goes down during

starvation and increases immediately after the assimilation of food.

The blood in the capillary network of the liver is collected by small veins which join to form the two *hepatic veins*. These flow into a large vein, known as the *postcaval* or

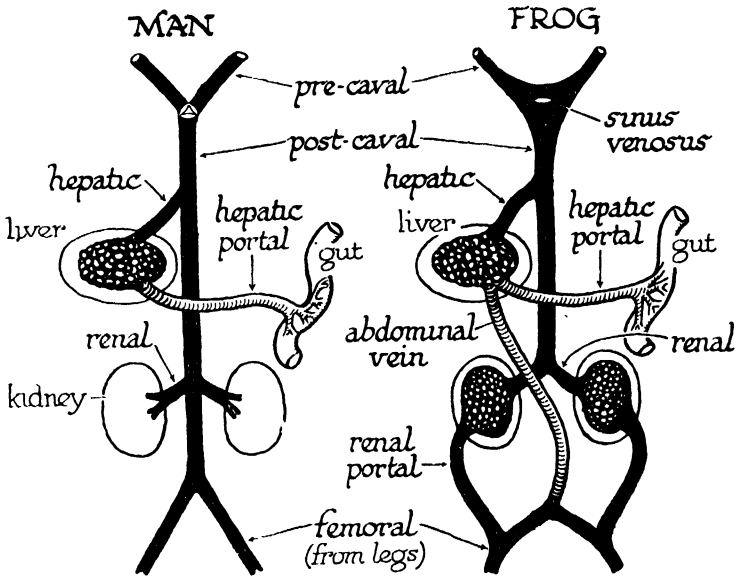

FIG. 51—MAIN VEINS OF MAN AND FROG

inferior vena cava, that picks up blood from the kidneys and discharges it into the thin-walled chamber of the heart known as the *sinus venosus*. Into the sinus venosus flow two large veins from the head and fore limbs, known as the *precavals* (right and left). The principal tributaries of each pre-caval are the *jugular* veins, bringing back blood from the head, the *subclavian* veins bringing back blood from the capillary network of the arms, and the *musculo-cutaneous*, which bring back most of the blood from the skin of the

trunk. Apart from the lungs we have still to account for the blood which returns to the heart from the lower limbs, and this has been left to the last, because in this respect the venous circulation of the frog is somewhat different from that of the human being. In the frog the principal vein of the leg, called the *femoral vein*, divides. One branch, the *renal portal vein*, breaks up in the capillaries of the kidney,

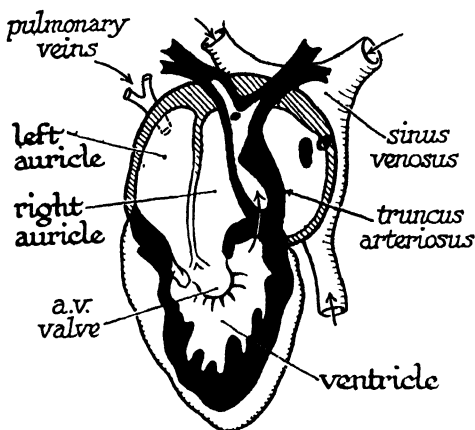

FIG. 52—THE HEART OF THE FROG

just as the hepatic portal vein breaks up in the capillaries of the liver. The principal vein of the leg of a human being joins the postcaval directly. There is, as far as we know, no special advantage in the *renal portal* system of the frog. Not all the blood from the leg of the frog passes back into the heart through the renal portal system. Two vessels from the femoral veins meet in the mid-ventral line to form a conspicuous vessel running up under the muscular wall of the trunk. This vessel, the *abdominal* or *epigastric vein*, discharges with the hepatic portal into the capillary bed of the liver. It is not present in the adult human being, but is

represented in the human embryo. The most important fact about the venous circulation of both the frog and man, and we might add of fish or fowl, is the hepatic portal system, that is to say, the fact that all the blood returning from the alimentary tract passes through the capillary network of the liver *en route* for the heart. The glycogen-storing activity of the liver is its most important role in the economy of the body. In human beings the liver stores a good deal of fat. The frog possesses special masses of fatty tissues, the fat-bodies attached to the kidneys. These diminish greatly in size during hibernation (winter sleep), when no food is available.

We have now described the larger veins, which bring back blood from the capillaries of all parts of the body, except the lungs. We have next to describe the structure of the frog's heart. The heart of the frog consists of three portions, the *sinus venosus*, a thin-walled chamber into which the pre- and post-caval veins pour blood; a portion, the *atrium*, with somewhat thicker walls, divided completely into two chambers, the right and left *auricles*; and a very thick-walled chamber, the *ventricle*, which pumps blood out into the arteries. The sinus venosus opens into the right auricle. Into the left auricle open two small veins, the *pulmonary* veins from the right and left lungs. Both auricles discharge into the ventricle. Between the auricles and the ventricle is a flap of fibrous tissue connected by fine cords of tendon to the inner wall of the latter. This is called the *auriculo-ventricular valve*. The whole of the heart is composed of muscular tissue, and it will continue to beat when it is removed from the body, devoid of all connexion with the nervous system. The chambers of the heart contract and relax in orderly succession, the sinus venosus first, the auricles next, and the

ventricle last. The contraction of the sinus venosus forces blood into the right auricle. When the auricles contract blood is forced into the ventricle. As the latter fills up, the auriculo-ventricular valve floats upward, so that, when the ventricle contracts in its turn no blood can pass backwards into the auricles (Fig. 52).

From the ventricle emerges a single arterial trunk, the *truncus arteriosus*. On either side it divides into three large arteries (Fig. 50). The most anterior of these is the *carotid*, whose ultimate branches end in the capillaries of the head region. The most posterior is the *pulmo-cutaneous* supplying the lung, and sending a small artery to the skin of the trunk. The middle one, known as the *systemic*, supplies a larger area, and requires more detailed description. Each systemic gives rise to a *subclavian* or *brachial* artery, which runs outward to the forelimbs, where its ultimate branches terminate in the capillary network of that region. The two systemics meet in the middle line of the body, dorsal to the postcaval vein, to form a single median artery, the *aorta* or *dorsal aorta*. From the dorsal aorta springs one large median artery, the *cœliaco-mesenteric*, whose terminal branches end in the capillary network of the gut and liver, etc., paired *renal* arteries, whose final ramifications end in the capillary network of the kidneys; and a pair of *iliac* arteries which supply the hind limbs.

The arteries have thicker walls than the veins, and except at the point where the carotid, systemic, and pulmonary arteries leave the truncus arteriosus, and at the origin of the latter from the ventricle itself, they have no valves like those which are found in the veins. The blood in the arteries is at a much higher pressure than the blood in the veins. Blood spurts from a cut artery and trickles from a vein. The

reason for this is that the fine tubes of the capillary network offer a considerable frictional resistance to the flow of the blood; as is easily appreciated when we remember how hard it is to blow air or water through a very fine jet. In consequence the energy of the blood-flow in the veins (Fig. 53) is much less than in the arteries, and the presence of valves in their course ensures that the blood cannot flow back, when

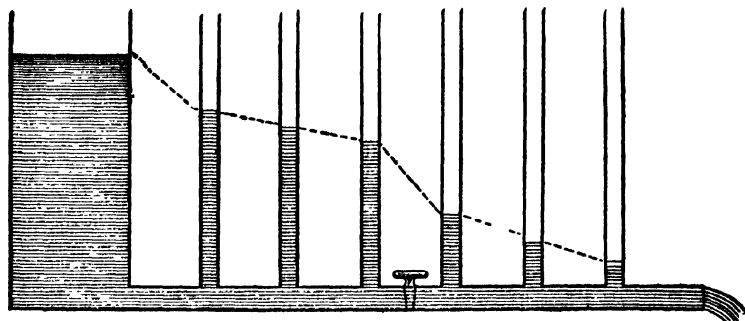

FIG. 53—PHYSICAL MODEL

To illustrate resistance of the capillaries to arterial pressure. An additional resistance is introduced by the small bore of the tap in the course of the horizontal outlet.

the arterial pressure falls while the ventricle is relaxing in the act of filling.

Regulation of blood-flow.—The amount of blood flowing through an organ varies. To some extent it is adjusted to the oxygen requirements of the moment. Other things being equal, the rate at which a tissue can take up oxygen depends upon the amount of blood which flows through it in unit time. Now the flow of a liquid through a tube of uniform bore depends upon the force propelling it, the length traversed, and the sectional area of the tube. Only the first and last of these need be considered in connection with the circulation, because the length of tube traversed is approximately con-

stant in the blood vessels. As the activity of the heart is an intermittent quantity, the average force of the heart-beat depends partly on the frequency of the beat, or pulse rate, and partly on the amplitude or strength of the individual beats. Heart muscle reacts to stretching by increased frequency and amplitude of beat, so that any increase in the resistance of the finer blood vessels calls forth more powerful action on the part of the pumping organ. Furthermore the heart is regulated by two sets of nerves, branches of the sympathetic system and the vagus respectively. The former can discharge impulses which augment, the latter impulses which inhibit the heart beat. The increased pulse rate following excitement or excessive exercise is due to the action of the former. The variations of heart rhythm that are thus possible affect only the circulation as a whole.

Changes in the blood supply of single organs are possible, because the arteries and the veins,* like the intestine, have walls with a double coat of plain muscle, one coat with the fibres arranged circlewise and one with the fibres arranged lengthwise. The extent of contraction of these muscle fibres is under nervous control, and any change in the extent of contraction of the muscular walls of the blood vessels means that the diameter of their bore is increased or diminished. The capillaries have no muscle fibres in their walls, which are formed of a single layer of cells. The latter possess a measure of contractility. Blushing results from dilation of the smaller arteries and capillaries of the skin of the face. Loss of heat from the surface of the body, when exposed to cold, is compensated by constriction of the blood vessels of the skin, hence the whitening of the surface after bathing in very cold water. Sometimes the capillaries remain dilated

* The arteries have much thicker muscular walls than veins.

while the smaller arteries are almost completely closed up. When this occurs, stagnant pools of blood occur in the capillary network and as their oxygen is used up the blood itself becomes completely reduced. This is what happens when the tips of the fingers become blue on a cold day.

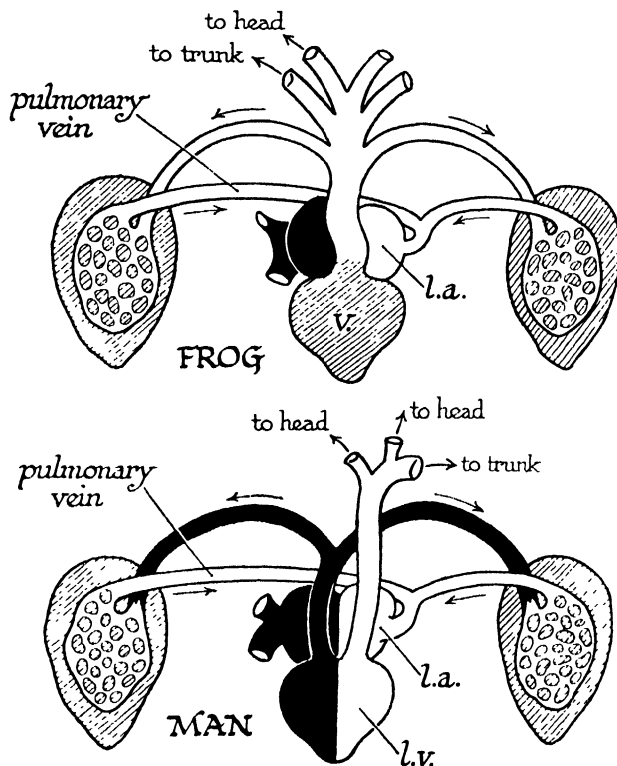

FIG. 54—THE RELATION OF THE HEART TO THE LUNGS AND TISSUES
Above—in the frog. Below—in Man.

The blood of the frog is never warmer than the atmosphere, and the animal cannot withstand either great cold or high temperatures at which we can easily live. Our blood is kept at a constant temperature (about 37° C.) in ordinary

circumstances, and when we are exposed to a warmer temperature, secretion of sweat takes place. The evaporation of sweat from the surface of the body absorbs heat, thus keeping the surface cool.

The Lymph.—Except in the spleen, a structure concerned with the removal of effete red corpuscles, the blood does not come into direct contact with the tissue cells. It is separated therefrom by the thin wall of the capillary bed, which is one cell layer in thickness. The spaces between the tissue cells are filled with a clear fluid, *lymph*, containing white corpuscles. Chemical exchange takes place between the cells and the lymph on the one hand and the lymph and the blood on the other, by physical diffusion. In the frog there are large lymph spaces between the skin and the muscles, and in addition to the abdominal cavity or peritoneum and the cavity around the heart or pericardium, a large lymph space in which the kidneys lie is separated by connective tissues from the abdominal cavity proper. The lymph spaces in the absorptive wall of the human intestine; known as *lacteals* (Fig. 54A), communicate with a well-defined channel, the *thoracic duct*, which opens into the jugular vein. The lacteals are so called because they are found to be gorged with droplets of fat, after a meal of fatty constituents, and it seems that the bulk of the fatty portion of the food is absorbed into the circulation by this indirect route. Masses of dividing cells which are manufacturing new white blood corpuscles occur in the course of the lymph spaces. These are spoken of as *lymph glands* and are usually enlarged in inflammatory conditions. The tonsils are large lymph glands. The red blood corpuscles are manufactured in the bone marrow. In the lymph space on either side of the urostyle of the frog there occur small strands of striped muscle which contract rhyth-

mically, and are called the *lymph hearts*. Their pulsation can be easily detected through the skin in the intact animal, but their precise significance is not clearly understood.

The Human Circulation.—The circulation of the frog

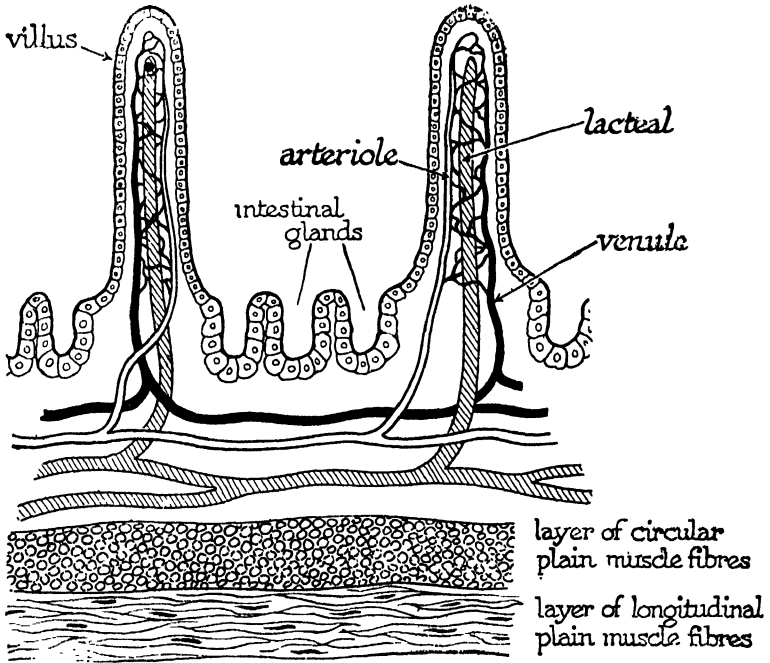

FIG. 54A—BLOOD SUPPLY OF SMALL INTESTINE

differs in several respects from that of the human being, and of all warm-blooded forms. It is much less efficient as a means of discharging the principal office of the circulatory system, the transport of the respiratory gases. Both the deoxygenated purple blood coming from the tissues of the body as a whole *via* the right auricle, and the oxygenated blood returning from the lungs *via* the left auricle, have plenty of opportunity for mixing in the single ventricle

which pumps blood out into the arterial system. But the human heart is four-chambered. Its ventricle is completely divided into two. From the right ventricle the pulmonary arteries supplying the lungs emerge. From the left ventricle there springs an artery which divides to form paired carotids, paired subclavians, and the aorta itself. Blood coming from

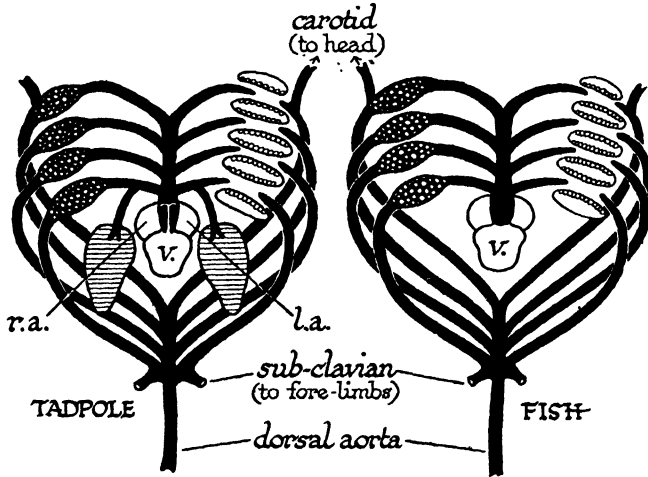

FIG. 55—DIAGRAM OF GILL ARCHES AND HEART OF A TYPICAL FISH (right), AND TADPOLE OR LUNG FISH (left)

The gill clefts are seen on one side and the gill capillaries schematically on the other.

the capillaries of the trunk, limbs, or head passes into the right auricle, thence into the right ventricle, thence by the pulmonary arteries to the capillary network of the lungs, thence by the pulmonary veins to the left auricle and out of the left ventricle by the carotid, subclavian, and aortic trunks to the rest of the body. Thus all the blood that supplies the tissues is fully oxygenated (Fig. 49).

The frog is really a half-way house between a fish and a human being. In its tadpole life the frog has a circulatory

system essentially like that of a fish. At a certain stage of our embryonic life, we, too, have a circulation of this type, succeeded by one that is very much like that of the adult frog. The fish is an animal that breathes oxygen dissolved in water by passing a current of the latter through slits in the sides of the throat. These are provided with filaments

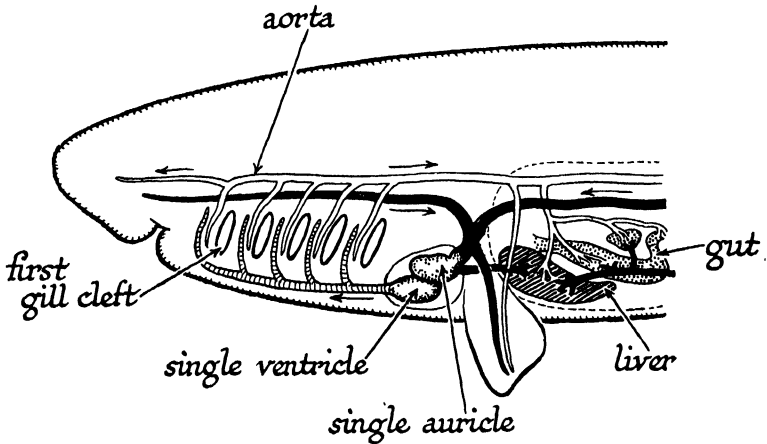

FIG. 56—BLOOD SYSTEM OF A FISH

The front end only of the fish is shown. The veins are in black and the arteries, which carry deoxygenated blood from the heart to the gills, are lightly shaded. The portal vein, which carries blood from the gut to the liver, is also shown.

richly supplied with capillaries and known as gills. The fish heart is single throughout; the atrium is not divided into two separate auricles. All the blood from the body entering the heart is deoxygenated, and passes from the ventricle into a median artery which pumps blood by a paired series of arteries to the capillaries of the gills. Thence they are collected by arteries which join to form the aorta (Figs. 55 and 56). Many fishes have a structure, known as the swim-bladder by which they adjust their specific gravity. In a few fishes,

such as the lung-fishes, it opens into the throat and is used as a lung. The lung of these fishes is supplied by an artery from the last of the gill arches. This precisely corresponds to

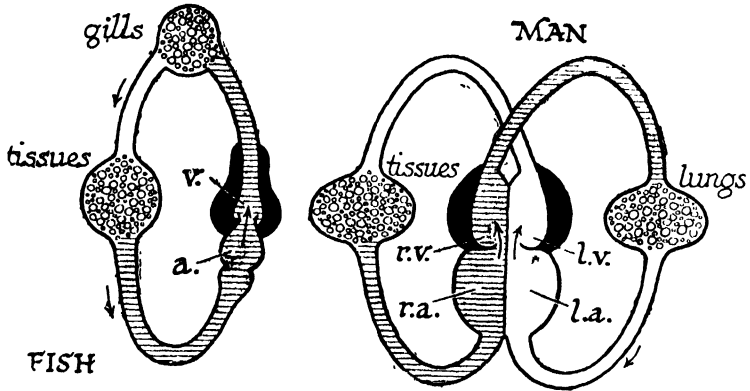

FIG. 57—DIAGRAMMATIC REPRESENTATION OF THE OXYGENATION OF THE BLOOD IN FISH (left) AND MAN (right)

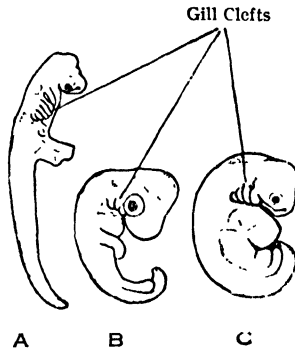

FIG. 58—EMBRYOS OF (A) SHARK, (B) BIRD, (C) MAN AT THE STAGE WHEN THE GILL CLEFTS ARE FORMED

The gill clefts never become completely perforated in birds and mammals, but skeletal and circulatory arrangements of the fish type are temporarily associated with them.

the arrangement in the frog just before it develops its limbs and sheds its tail, and it corresponds with the stage in our own development, when we possess gill-clefts like a fish.

When the frog undergoes metamorphosis the median artery which gives rise to the paired gill arteries persists as the truncus arteriosus. The last gill arch loses its connexion with the aorta, persisting as the pulmocutaneous. The one immediately in front persists as the systemic by absorption of its capillary network. Such a stage exists in our own development. At an early stage the human embryo has *pharyngeal*

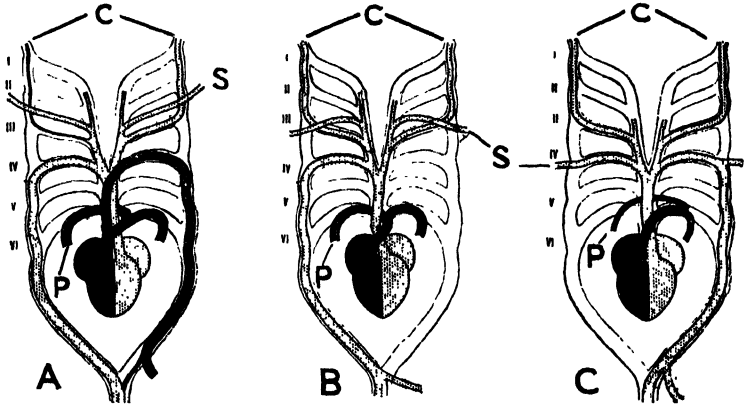

FIG. 59—ARTERIAL ARCHES OF REPTILE (A), BIRD (B), AND MAMMAL (C) The Roman numerals refer to the embryonic arches. C, carotid artery; S, subclavian artery; P, pulmonary artery. Vessels carrying deoxygenated blood are shown black.

clefts like those of a fish or tadpole, but they do not actually carry gill filaments. Later the truncus arteriosus becomes progressively shorter, so that the pulmonary, systemic, and carotid trunks come off directly from the ventricle, within which a septum is formed. In reptiles (lizard and tortoise, etc.) there is no truncus arteriosus, and there is an incomplete* septum in the ventricle, but both systemics persist. In birds the ventricle is completely divided, as is our own heart, but the single aorta is on the right side of the heart and not on the left, as in man (Fig. 59).

* The ventricular septum is complete in crocodiles.

TABLE OF OXYGEN-TRANSPORT

Fishes (and Cyclostomes)	Amphibia (and Lung Fishes)
1. The Atrium is undivided and receives only deoxygenated blood from the tissues.	The Atrium is divided into a <i>Right</i> auricle which receives
2. The ventricle is undivided.	
3. <i>Deoxygenated</i> blood is pumped from the ventricle to the gills by the <i>ventral aorta</i> .	Mixed blood leaves the ventricle for the lungs and tissues by the single <i>truncus arteriosus</i> .
4. Oxygenated blood is conveyed from the gills via the <i>dorsal aorta</i> to all the other tissues of the body.	
5. —	<i>Both</i> systemic arches convey <i>mixed</i> blood to the dorsal aorta in completely terrestrial species.

The differences between the *venous* system of a fish and that of a land Vertebrate are not obviously connected with differences of habit or habitat. Fishes do not have well-defined veins with a muscular wall and valves. The blood of a fish flows back to the heart by wide channels called *sinuses*. In all fishes except the lung fishes the blood from the kidneys returns to the heart by paired vessels (*postcardinal* sinuses) (Fig. 6o) which join the *Cuvierian* (i.e. precaval) sinuses.

IN THE VERTEBRATE BODY

Reptiles	Birds	Mammals
----------	-------	---------

Left auricle which receives *oxygenated* blood from the *Lungs* and a *deoxygenated* blood from the *Rest* of the Body.

The ventricle is more or less completely divided.	The ventricle is completely divided.
---	--------------------------------------

The pulmonary artery arising from the right side of the ventricular septum takes only *deoxygenated* blood to the lungs.

The *Right* systemic arch from the *left* side of the ventricular septum conveys *oxygenated* blood to the head, to the fore limbs, and to the aorta.

The *Left* systemic arch from the *left* side of the ventricular septum takes *oxygenated* blood to all the organs (except lungs).

The *Left* systemic arch from the *right* side of the ventricular septum conveys *deoxygenated* blood to the dorsal aorta, so that the hind end of the body gets mixed blood.

The *Left* systemic arch has disappeared and the whole body (except lungs) gets *oxygenated* blood from the *right* systemic arch.

The *Right* systemic arch has disappeared.

So it does not mix with the blood from the liver before it enters the sinus venosus, and there is no sinus which corresponds to the postcaval vein. Postcardinal vessels are present in the embryos of land Vertebrates before a postcaval vein develops. In salamanders they persist intact throughout adult life. The *asygos* veins which bring back blood from the inside of the thorax are the remains of the embryonic post-cardinals of Man and other mammals. Fishes, like land

Vertebrates, have a hepatic portal circulation. The hepatic portal vessel of fishes is more like a true vein than the sinuses which join the heart.

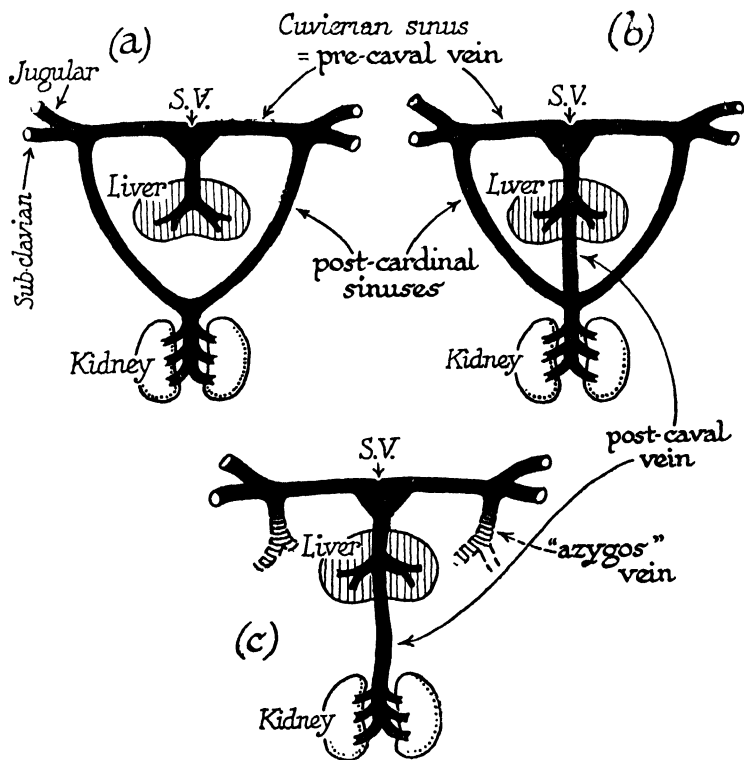

FIG. 60—VENOUS SYSTEM OF VERTEBRATES

- (a) Adult Fish (Early Embryo of Frog or Man).
 (b) Adult Newt or Lung Fish (Tadpole or Human embryo).
 (c) Adult Land Vertebrate.

The ductless glands.—In the activities of the body of Man or the frog the blood plays a part to which we have not referred so far. We have already seen what an important part the nervous system plays in co-ordinating the responses

of an animal with the events occurring around it. There is another kind of co-ordination that is sometimes called

TABLE OF VENOUS SYSTEM OF VERTEBRATES

Fishes other than Lung Fishes	Newts and Lung Fishes	Land Vertebrates other than Newts and Mammals	Mammals
1. The blood from the gut passes through the capillaries of the liver by the hepatic portal vessel before it reaches the heart.			
2. The blood flows from the tissues to the heart in vessels (<i>sinuses</i>) without valves or muscular walls.	The blood flows from the tissues to the heart by vessels (<i>veins</i>) with valves and muscular walls.		
3. The blood from the hinder part of the body reaches the heart by the <i>post cardinal</i> vessels which do not join the <i>hepatic</i> vessels before reaching the heart.	The blood from the hinder part of the body reaches the heart either by postcardinal vessels or by the <i>post-caval</i> which receives the hepatic vessels before it joins the sinus venosus.	All the blood from the hind part of the body flows back to the heart by the post-caval vein which receives the hepatic veins before reaching the heart.	
4. There is a <i>sinus venosus</i> and a <i>renal portal</i> system.			There is no <i>sinus venosus</i> and no <i>renal portal</i> system.

chemical co-ordination. It is a matter of common knowledge that certain chemical substances, generally called drugs, obtained from the tissues of plants, have very characteristic effects on certain organs of the body. For instance the drug

known as caffeine, present in small quantities in coffee, promotes secretion of urine. Certain organs of the body produce drug-like substances called *hormones*, which, when carried by the blood stream to other parts, are capable of calling forth very specific responses. In this way the circulatory system plays a part in co-ordinating response and stimulus.

The first discovery of chemical co-ordination was made by Bayliss and Starling in 1902 while investigating the secretion of pancreatic juice. The pancreas does not secrete its digestive juice continuously, but only as a definite response to the entry of the acid food from the stomach into the intestine. Now the secretion of pancreatic juice follows after the introduction of food or acid alone, even when all the nerve connections between it and the intestine are severed. Bayliss and Starling found that if the lining of the intestine is ground up with a little weak acid the concoction, when injected into the circulation, produces immediate flow of pancreatic juice. They therefore concluded that acid liberates a substance, which they called *secretin*, from the intestinal mucous membrane into the blood stream, whence it is conveyed to the pancreas and there evokes the characteristic response. This substance has now been prepared in chemically pure form. Bayliss and Starling's first experiments were performed with dogs. But they later showed that secretin is present in the intestinal wall of the toad and that of species belonging to other classes of Vertebrates.

An example of chemical co-ordination that has been worked out in frogs and toads is the control of colour response in these animals. We know that they change colour according to temperature, illumination, humidity, etc., and that they change uniformly over the whole body. We know also that nerves convey to the central nervous system the impulses

set up by appropriate stimuli in their surroundings. It was at one time thought that the nervous system transmitted these impulses directly to the melanophores or black pigment cells. This is not so. In fact it is doubtful whether the melanophores of the frog have any nerve supply. Within the skull beneath the brain of the frog and of man himself lies a little gland which has no duct conveying its secretion to the exterior. Extracts made by grinding up this organ, the *pituitary gland*, in salt solution have some very remarkable properties. In particular, when injected into a pale frog, they bring about within half an hour a complete darkening of the skin resulting from expansion of the melanophores (*Frontispiece*). There is enough of the active constituent in one gland to bring about darkening in a hundred individuals. When the pituitary gland is removed, the frog recovers and survives, but in whatever circumstances it is kept, it will always remain pale. Darkening of the skin in a frog from which the pituitary gland has been extirpated can still occur, if a small quantity of the extract of the pituitary gland (about equivalent to one-millionth of a gram of the gland substance) is introduced into the circulation by injection. It thus seems that the nervous system controls the behaviour of the pigment cells by increasing or diminishing the rate at which the pituitary body pours its secretion into the blood.

Over the surface of each kidney there is an orange-coloured mass of tissue, the *adrenal body*. It contains a drug-like

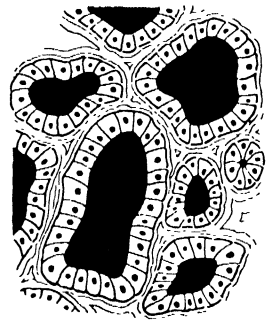

FIG. 61 — MICROSCOPIC SECTION OF THE THYROID GLAND

Showing follicular cysts lined by cubical epithelium and filled with a jellyish material.

substance that acts on plain muscle, in some cases relaxing and in others inducing contraction or increased rapidity of an inherent rhythm. Thus it accelerates the heart of the frog and relaxes the muscular wall of the intestine. This substance, *adrenalin*, can now be manufactured in pure form in the laboratory. It is liberated into the circulation in small quantities, but we are not as yet certain under what conditions. The adrenal and pituitary bodies are sometimes spoken of as *ductless glands*. A third ductless gland, the thyroid (Fig. 61), is dealt with in the next chapter.

TOPICS FOR HOME STUDY

1. Name the respiratory pigments. Describe their chemical nature and properties and the part they play in the living body.
2. Contrast the oxygenation of the blood in dogfish, frog, tortoise, fowl and rabbit.
3. Describe the Hepatic and Renal portal circulation in fish, frog, bird and mammal.
4. Tabulate the uses of the blood.
5. Describe the microscopic structure of blood vessels giving the differences between arteries, capillaries and veins. What are the functions of the following: (a) valves; (b) muscular walls of arteries; (c) capillaries.
6. Describe the role of blood in (a) heat regulation, (b) protection against diseases, (c) chemical co-ordination.

CHAPTER VII

THE DEVELOPMENT OF A NEW ORGANISM

WE have now studied the part played by the various structures of the body of such an animal as the frog in its everyday behaviour. We shall now consider for a short space the process of building up a living creature. The development of the egg of a frog, as described by Newport and his successors, has a very great advantage over that of other forms as an aid to understanding the way in which the complex architecture of the body is built up. Some of the most important features of the process can be followed with no more elaborate apparatus than a simple hand lens. A few hours after fertilization, divisions of the egg into separate compartments or *cells* follow in rapid succession (Fig. 7). At the time of fertilization the egg shows a concentration of black pigment towards the uppermost pole. Division proceeds according to a fixed rule. The first division is parallel to the vertical axis, and the second is also in a vertical plane. The third division is in the horizontal plane, and separates off a tier of cells which contain black pigment from a tier of somewhat larger colourless cells. Successive divisions take place in all planes. A hollow sphere is thus formed. The cells of the lower part are relatively larger and contain no black pigment (Fig. 62, cf. Fig. 11).

Up to this stage the only hint of any differentiation of the immature being, or *embryo*, into separate tissues or organs is the demarcation between the upper zone of smaller black cells and the lower zone (Fig. 62A) composed of a somewhat irregular mass of cells rich in storage material or yolk.

Now begins the stage of organ building. Soon almost the entire surface of the embryo is covered with a layer of small pigmented cells, the large unpigmented cells being evident

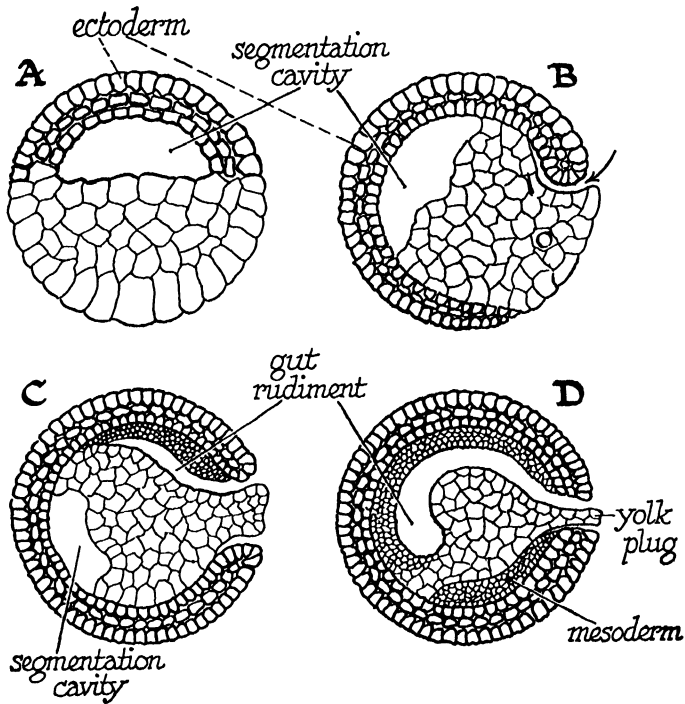

FIG. 62—FOUR EMBRYOS OF FROG
Showing stages in excavation of the primitive gut.

only at one end, the *yolk plug*. This is destined to be the posterior end of the tadpole (Fig. 62).

Now begins the differentiation of two systems of organs characteristic of the adult animal—the gut or alimentary canal and the central nervous system. The black outer covering of cells forms a distinct lip over the yolk plug on one side. A small chink beneath this lip grows inwards,

enlarging as it grows. This is the rudiment of the alimentary cavity (Fig. 62B–D) of the tadpole. It is the embryonic gut. Meanwhile a groove appears on the surface of the embryo from the region (Fig. 63) just above the lip already referred to. The groove is wider in front, and as it deepens, its edges grow up, and coalesce, so that a tube is formed beneath a thin covering of cells. This tube, broadest at the future head end, is the rudiment of the spinal cord and brain. While this has been going on, cavitation of the mass of internal

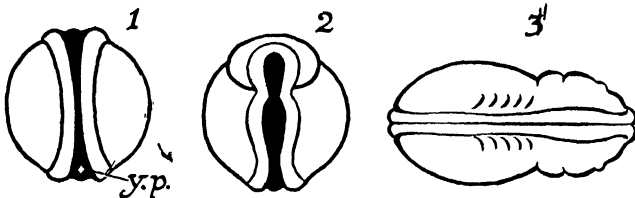

FIG. 63—(1) POSTERIOR, (2) ANTERIOR, AND (3) DORSAL ASPECT OF THE FROG EMBRYO AT THE STAGE WHEN THE NEURAL GROOVE IS CLOSING UP

unpigmented cells has progressed inwards from the yolk plug.

The original cavity of the sphere has been obliterated. The new cavity excavated inwards from the yolk plug is destined ultimately to become the cavity of the alimentary canal. As this cavitation proceeds, a belt of cells is separated off from the mass of colourless cells which form the innermost part of the embryo. This belt of tissue (*mesoderm*) is derived from cells which migrated inwards from the lips surrounding the yolk plug and is destined to give rise to the body musculature, including the walls of the blood vessels which arise as canals in it. Beneath the dorsal rudiment of the central nervous system a rod of tissue is detached from the roof of the primitive gut in the mid-dorsal line. The cells of this rod

later become vacuolated, and the structure constitutes a stiff skeletal axis, the *notochord* (Fig. 64). Around the notochord, which is found in all Vertebrate embryos, the vertebral column is built up at a later stage, and in land Vertebrates the notochord is entirely replaced in later life by the solid axes of the vertebræ (*centra*, *vide* Chapter XII), but in fishes it persists to a greater or less extent throughout life.

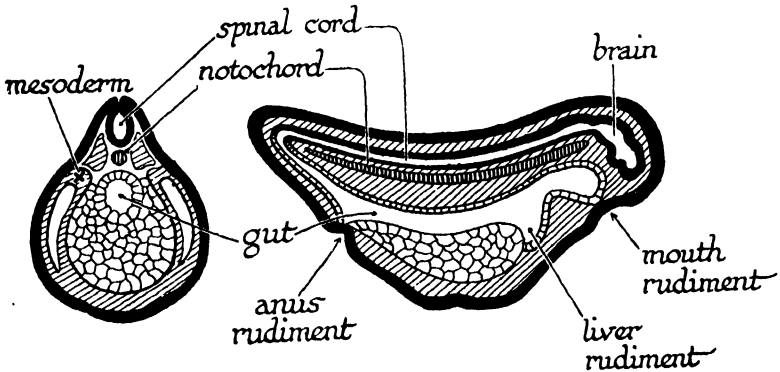

FIG. 64.—TRANSVERSE AND LONGITUDINAL VIEWS OF FROG EMBRYO SHORTLY BEFORE HATCHING

Development of the Chick and Human Being.—The development of the egg of the fowl or of the human being is in one way essentially unlike that of the frog or of a fish. Segmentation in the fowl and in man leads to the formation of a number of membranes which enclose the embryo before birth, but are discharged at the end of the embryonic life. After fertilization, the nucleus of a fowl's egg divides repeatedly, but as the yolk does not all divide with the nuclei, a thin plate of cells is demarcated on the surface of the remaining yolk (Fig. 65). This plate of cells grows over the surface of the egg, and gives rise to a sac enclosing the yolk and to a series of envelopes which wrap round the embryo proper (Fig. 66).

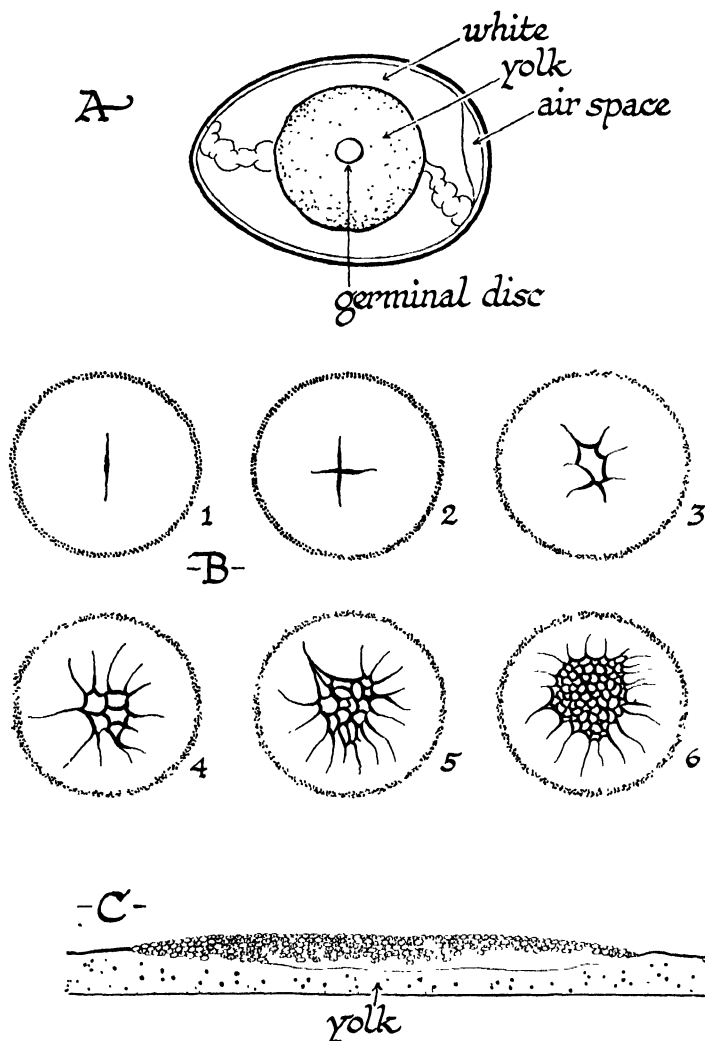

FIG. 05—EARLY STAGES IN THE DEVELOPMENT OF THE EGG OF THE DOMESTIC FOWL

- (A) Diagram of unfertilized egg.
 (B) Six stages in the segmentation of the germinal disc.
 (C) Vertical section through the germinal disc when segmentation complete.

The remains of the yolk sac are often present at the time of hatching.

The human egg cell has practically no yolk, and it develops

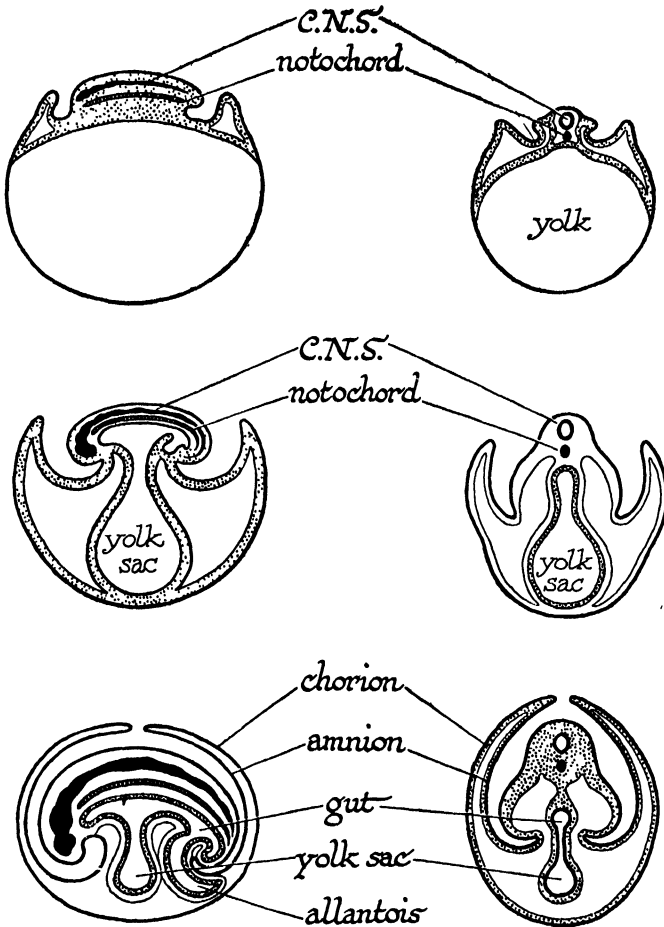

FIG. 66—FORMATION OF THE FETAL MEMBRANES OF THE CHICK

On the left longitudinal, right transverse, sections with reference to the long axis. Top—at end of first day of incubation; middle—at end of the second; bottom—a later stage.

at first into a hollow ball of cells like the egg of the frog, but only a part of this hollow sphere grows into the embryo. Like the embryo fowl, the embryonic human being is invested with a series of envelopes. These envelopes, more

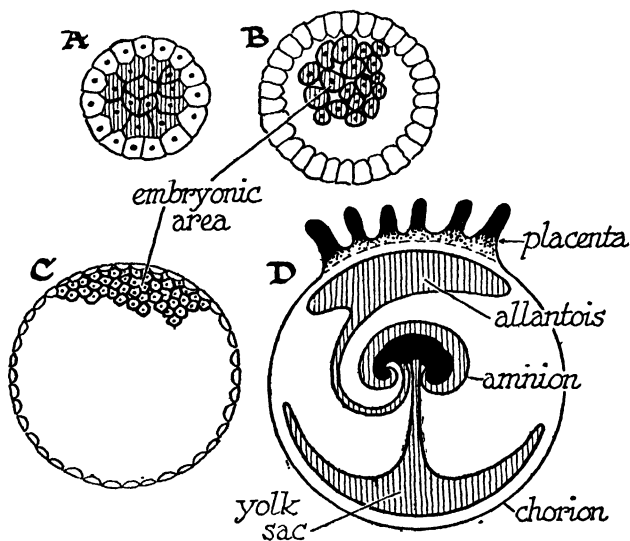

FIG. 67—THREE STAGES IN THE DEVELOPMENT OF THE MAMMAL

(A) Early cleavage stage. (B) and (C) Separation of the embryonic area.
(D) Fœtus with its membranes.

especially the *allantois* (Figs. 66, 67), enter into very close connexion with the wall of the womb, which is specially well supplied with blood vessels during the nine months during which development completes itself within the body of the mother. The structure formed by this fusion of maternal and embryonic tissues is called the *placenta*. By diffusion of nutrient matter through the thin films of tissue which separate the blood vessels of the mother from those

of the embryo, the latter is able to grow in spite of the fact that the egg itself has no storage. A feature common to the development of the fowl and the mammalian egg is the fact that, though it will develop into a land animal, the embryo at a certain stage has clefts on the side of the throat like those through which water passes over the gills of the tadpole or adult fish (Fig. 58).

Metamorphosis.—After the embryo of the frog has reached the stage when the gut rudiment and the beginnings of the nervous system have been differentiated, it grows more rapidly in the axis parallel to the length of the spinal cord. After about a fortnight the head and tail ends are distinguishable. The muscles of the tail are sufficiently active to enable the embryo to wriggle out of the mass of jelly in which the eggs are laid. Independent existence starts. Unlike ourselves, the frog does not begin its separate existence with an organization very much like the sexually mature form. The human baby at birth is essentially an immature adult. The chief difference is that it has no teeth, and even after it acquires teeth it has to shed one set of them before the permanent set appear. The sexual organs are immature and remain so until about the age of fourteen, when certain minor distinctions between the sexes (*secondary sexual characters*) such as the pitch of voice, presence of hair on the upper lip and chin of the male, and enlargement of the milk glands in the female, become evident.

Otherwise a human adult is in most respects, anatomically speaking, a grown-up baby. But the embryo of the frog, which has hitherto grown at the expense of food or “yolk” stored in the egg, is very different from the adult when it first starts independent feeding. It breathes like a fish by gills and not by lungs. The arterial system is essentially fish-

like. It has no fore limbs and only the tiniest rudiments of hind limbs. It possesses a tail.

On each side of the throat in the newly hatched tadpole of the frog, shortly after the time of hatching out, there are

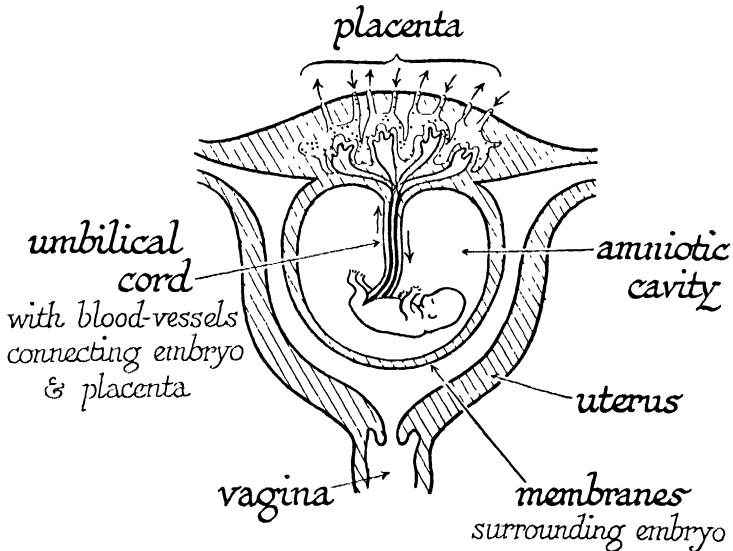

FIG. 68—HUMAN FŒTUS IN THE UTERUS ABOUT TWO MONTHS AFTER CONCEPTION

The black lines in the placenta represent diagrammatically the capillaries containing the blood of the fœtus, and the dotted spaces connect with the blood system of the mother. The arrows show the circulation of the blood in both.

four clefts which communicate with the exterior and with the throat, thus letting water pass from the mouth outwards. The walls between these clefts are known as the gill arches. From the first three gill arches there grow out on either side tufts of filaments well supplied with blood vessels. These “external” gills disappear within a few days after the tadpole begins to swim, and the sides of the gill

arches become covered with epithelial folds very richly supplied with blood vessels like the gills of a fish. A fold of skin, the operculum, also similar to that of a fish, grows back over the gill clefts, as in many fishes, and conceals the gill from outside. The tadpole continues to breathe partly by its skin and partly by passing water over the gill clefts, which absorb the oxygen contained in it; and at first it has no true lungs. This state of affairs is not permanent. The tadpole stage of the British common frog lasts only about three months. An abrupt change supervenes; and in a very short time the adult characteristics are assumed. This change is called the *metamorphosis*. The preceding phase or tadpole stage is spoken of as the *larval period*. At metamorphosis the hind limbs, which in the half-grown tadpole are tiny rudiments, begin to grow rapidly; then the rudiments of the fore limbs break through the skin. Finally the gill clefts begin to close up and the tail shrinks. A four-legged, air-breathing, tailless adult emerges on to land.

The way in which an animal develops is a very difficult problem to understand, and we are only just beginning to do so. It is possible to experiment with the development of a frog or toad just as it is possible to experiment with the heart or the stomach (Fig. 69). We can make the eggs of a frog or toad grow up into individuals with two heads or two tails or with one eye on the top of the head instead of two (Fig. 70). One question about the development of the toad or frog which we are beginning to understand is of considerable importance to medicine and agriculture. This is, what brings about the sudden transformation from the tadpole into the adult form?

In the neck of human beings there is a flat lump of glandular tissue known as the *thyroid gland*. It is represented in

the frog by a pair of ovoid bodies on either side of two large veins of the neck region. In both man and the frog the thyroid gland consists of small capsules of a jellyish material and is very richly supplied with blood vessels (Fig. 61). Like

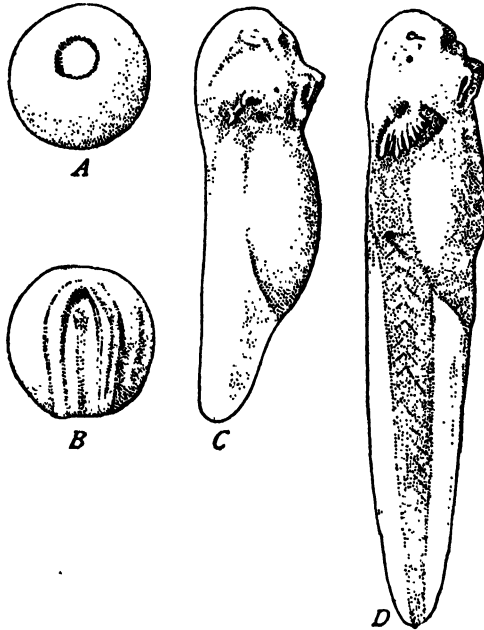

FIG. 69—EFFECT OF TEMPERATURE ON THE DEVELOPMENT OF THE FROG TADPOLE. (A) YOLK PLUG FORMED. (B) NEURAL FOLDS FORMED. (C) MAIN ORGAN-SYSTEMS FORMED. (D) READY TO HATCH, NOTE EXTERNAL GILLS. ALL THE EMBRYOS ARE THREE DAYS OLD, BUT THEY WERE KEPT AT 11°, 15°, 20° AND 24° RESPECTIVELY.

the adrenal and pituitary glands, two other structures which are somewhat like the digestive glands in texture, it has no duct. Such organs are for that reason sometimes called ductless glands. The jellyish material of the thyroid gland is peculiar in that it contains a compound of iodine, an element not found in other tissues of the animal body. When the

thyroid gland of any animal is given as food to young tadpoles they start to develop limbs and to lose their tails very rapidly.

A large American frog, which normally lives for two years in water as a tadpole, will undergo metamorphosis within six weeks from hatching if fed on thyroid gland instead of ordinary meat. The thyroid gland of the tadpole can be removed by a comparatively simple surgical operation about the time of hatching, and tadpoles deprived of their thyroid

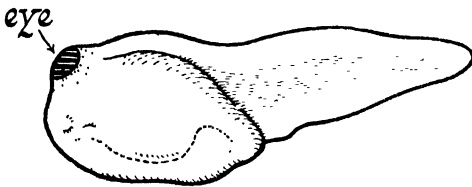

FIG. 70—ONE-EYED TADPOLE

Produced by exposing the yolk plug stage to the action of lithium chloride.

glands, though otherwise normal, will go on growing for years without undergoing metamorphosis. They never assume the adult characteristics. Among human beings there is a disease of infancy known as *cretinism*. Its characteristics include permanent undergrowth and persistence of childish characteristics. It can now be cured, as these cretin tadpoles can be cured, by giving thyroid gland (dried and in the form of a pill) as medicine. Metamorphosis occurs when the thyroid gland begins to pour its secretion into the blood. Tadpoles can also be prevented from developing into the adult form if kept in water free of any trace of iodine compounds. The thyroid is then unable to build up its secretion, which is an iodine compound. This compound can now be manufactured from pure chemicals in the laboratory. Allied

to the frogs and the toads are the salamanders, in appearance somewhat like a lizard without scales, but having a larval stage spent in the water like the tadpole.

Heredity and Environment.—There is a local variety of the Mexican salamander, which never grows into the land form in nature. It remains a sort of tadpole called the *axolotl*, and breeds in the immature state. Though a single meal of ox-thyroid (Fig. 71) suffices to turn it into a land salamander in six weeks, supplying it with iodine does not make it develop into a land form like that of similar salamander larvæ in other localities. Its own thyroid does not have the power to use iodine. The Mexican salamander does not develop into the land form in nature, because it *inherits* from its ancestors an inefficient thyroid gland. Tadpoles in mountain lakes sometimes fail to develop because there is insufficient iodine in their *environment*.

This gives us an opportunity for examining two words used very loosely by people who have no biological training. By inheritance we simply mean the stuff which the sperm and the egg contribute to the new being. How that stuff will shape depends partly on what sort of stuff it is, that is to say, on what sort of parents it came from; and partly on the surroundings in which it finds itself. Before the nature of reproduction was understood as we understand it to-day, it was generally believed that any bodily change which results from a change in our surroundings can be transmitted to our children. Experiment does not support this view, which was commonly believed in the past and was stated in a very explicit form by Lamarck in his *Philosophie Zoologique*. The hereditary stuff does occasionally undergo great changes (mutations). Sports (*mutants*) appear, and breed true to their new characteristics. Otherwise the same materials are trans-



FIG. 71—ON THE RIGHT, AXOLOTL LARVA OF MEXICAN SALAMANDER. ON THE LEFT, SAME SIX WEEKS AFTER FEEDING WITH THYROID GLAND—IT HAS NOW ASSUMED THE ADULT FORM.

mitted from generation to generation unchanged through the sperm and the egg. Heredity and environment are different aspects of development. *What we inherit is a capacity to develop in a particular way in a particular environment.*

Two authors have recently expressed this distinction very clearly in the following passage:

Many plants grow both high up among mountains and down in the plains and valleys. Those which grow higher up must exist in lower temperature, longer winter, more violent weather, poorer soil. As a result, they grow into a shape quite unlike that of the lowland variety. The Dandelion, for instance, when growing in the Alps is a dense rosette of small leaves, a long root, and a short flower stalk; in the lowlands, as we all know, its stalk may be long, its leaves large and spreading, its root (though too long for the gardener) much shorter. If dandelions from the Alps are taken down and grown in the plain, all their new growth is of lowland type, and in a short time they became indistinguishable from lowland dandelions, while exactly the reverse is true of lowland plants transplanted to the Alps. The same is true when seeds of the Alpine type are sown in the plains, and vice versa. The time spent in an Alpine environment has not in the least fixed the Alpine habit of growth.

This can be readily understood if we suppose that the Dandelion has a fixed constitution which, however, reacts differently to different external circumstances; it has, that is to say, a fixed capacity of being modified in special ways. This is obviously true for simple chemical substances. One particular sort of paraffin, for instance, melts at, say, 61° , another at 62° C. Keep the former in one environment—below 61° —and it stays solid; keep it above 62° , and it stays liquid. But you will not make it raise its melting-point however long you keep it melted. The two will continue to show their characteristic modifications in relation to heat—their original melting-points—as long as you like to keep them. To take another example, this time from the animal kingdom, attempts have been made to explain the black colour of the negro as the accumulated effect of generations of sun-burn. It is of course true that most white men in a tropical climate become sun-burnt; the strong sunlight has a direct effect on causing more pigment to form in the skin. But anybody can verify for themselves the fact that the children of

men tanned in this way are not noticeably less white than those of parents who have never left England.

What does this imply? Surely, that European and negro have different constitutions as regards skin-colour. The European stays pale in temperate countries, darkens in the tropics. But the negro is black wherever he lives. We can go back to our previous comparison; we can think of two grades of paraffin, one melting at 65° C., and the other at 40° C. The first, if kept in the shade, will remain solid throughout the summer in any region of the earth; but the other, though it would stay solid in an English summer, would be liquid in the tropics.

This interpretation would clearly leave no room for the Lamarckian theory, and, as time has gone on, more and more of the examples that Lamarckians claimed as proving their point have been shown to be explicable in some such way as this.*

When the Lamarckian principle was first challenged, even prominent scientists were willing to believe such fables as the story that a cock deprived of one eye transmits eye-defects to all his offspring. When it was conclusively proved that mutilations effected through several generations left no impress on the hereditary characters of the stock, the Lamarckians fell back on the gratuitous defence that only "adaptive" changes could be transmitted. The precise meaning of this adjective was never defined. No reason was forthcoming to suggest how the gonads could discriminate between mutilations and bodily changes that are "adaptive."

The "Neo-Lamarckian" view, that acquired characters gradually become impressed on the hereditary constitution only after countless generations, transfers the issue from the plane of verifiable experience to one of pure surmise, rendering further discussion meaningless. On one point we can be quite definite. If the Lamarckian idea is true there must be some mechanism by which the tissues of the body can influence the germ cells in a *specific* fashion. Experiments

* J. B. S. Haldane and J. S. Huxley, *Animal Biology*.

exist which throw light on the question, such as the work of Castle and Phillips (1909-11). If the ovaries of an albino guinea-pig are removed from the body and replaced by ovarian tissue from a black female of pure stock, the offspring produced when the ingrafted female is mated to an albino male are all black, without white hairs, as they would be in the case of a black female crossed to a white male. They are in fact indistinguishable from the offspring of a normal cross between a black and albino guinea pig.

To understand the tenacity with which the belief in the Lamarckian principle has clung to biological thought, we have to remember that the microscopic study of development is the most recently developed branch of anatomical science. The prevailing idea about development until the classical researches of von Baer and Meckel in the first half of the nineteenth century was that each organism was from the very first complete in all its parts and only needed growth to make its minute structure manifest to the eye. Caspar Wolff, in 1759, made observations on the hen's egg that led him to enunciate the "epigenetic" as opposed to the prevailing "evolutionary" view. That is to say, he sought to show that the hen's egg is at the beginning without any gross anatomical organization and that structural organization within the egg is a gradual development. His work was disregarded entirely at the time. Von Baer's researches on the same subject were published synchronously with the formulation of the Cell doctrine (1832). We may thus say that until the middle of the nineteenth century the current conception of inheritance in biology was closely analogous to the legal notion. The parent was supposed to hand on its characters to the offspring in the same sense as the well-to-do hand on their belongings. With so erroneous a concep-

tion of the nature of development to guide them, it is little wonder that the idea of the inheritance of acquired characters seemed a perfectly reasonable one. Nor is it any cause for surprise that the doctrine of Lamarck should have been first called in question during the decade that first saw a clear recognition of the nature of fertilization and the process of maturation in the germ cells.

The following passage from Goodrich (1924), also expresses the conclusion, elsewhere cited from Haldane and Huxley, with admirable lucidity:

Owing to that universal property of irritability or the power of response to stimuli already described, all organisms are the result of the interaction of the factors of inheritance, and the conditions of the environment. By the latter we mean all those conditions or stimuli which are capable of influencing the differentiation, growth, behaviour or, in other words, the metabolism of the organism. By the factors of inheritance, on the contrary, we mean that complex association (transmitted from the parents) of substances with properties or capacities which make up the specific inheritance characteristic of each organism, and which may be called its assemblage of germinal factors of inheritance, or its germinal constitution. They are contained in the germ-plasm, and constitute the physical basis of inheritance. Not only are organisms as we see them before us necessarily the results of the combined action of these factors and conditions, but so also is every part of them, every structure, every activity, every organ, every habit. Therefore the characters observed and measured, dealt with in statistics and experiments, are likewise their products. The inheritance might be compared to a musical instrument, the stimuli to the player, and the organism and its characters to the music produced. What particular tune is called forth will depend on the player, but the range of possible sound will be limited by the structure of the instrument, by the factors which make up its capacity to respond to the touch of the player.

Every character of whatever kind is, in a sense, partly acquired, since it is called forth by stimuli, and partly inherited, being a product of the activities of the germ-plasm; and no character is more acquired or more inherited than any other. Hence the popular

distinction between acquired and not acquired characters, between those which have been developed in the course of the individual's lifetime and those which are inborn, is misleading. The very terms involve a fallacy. We cannot point to this or that bodily or mental structure and say this is acquired and that is not. Characters being of the nature of a response must necessarily be produced anew at every generation. The characters of an organism are but the sum of its past responses.

Sir Ray Lankester (1894) drew attention to the important fact that characters are responses, and pointed out that Lamarck's first law, that a new stimulus alters the characters of an organism, contradicts his second law that the effects of previous stimuli are "fixed" by inheritance. The Lamarckian position is illogical, and to support it its advocates are driven to the performance of "illogical" experiments. They usually begin by taking an organism and submitting it to a new stimulus. If a change is thus induced, this very fact shows that the previous stimulus (under whose influence the organism has perhaps been living for centuries) has not "fixed" the character in inheritance. To prove that characters are rendered permanent, evidence is constantly brought forward that they are changeable.

Only those characters reappear regularly in successive generations which depend for their development on stimuli always present in the normal environment. Others, depending on a new or occasional stimulus, do not reappear in the next generation unless the stimulus is present. But both being equally due to factors of inheritance and to conditions of environment, the popular distinction between acquired and not acquired characters is illusory. In every case it is the material basis with the capacity to acquire, to become modified, or to respond, which is really transmitted; the direction and extent of the response depends on the stimulus encountered. The presence of a given hereditary factor cannot be determined by mere inspection of the characters of an organism; the factor may be present, but the corresponding character fails to show itself owing to the absence of the necessary stimulus. On the other hand, dissimilar stimuli acting on different factors may give apparently similar results. "*Heredity*" must be admitted to include two different processes—the *transmission* of the *factors* of inheritance, and the *reappearance* of *characters* in successive generations. To avoid confusion we speak of the factors as transmitted and the characters as inherited. It would be well to drop

altogether the use of the expression "acquired character." . . . Modifications are not transmitted as such. In the absence of the stimuli which originally gave rise to them they could only reappear if the new environment produced such a change in the factors of inheritance themselves that, when replaced in the old environment, they continued to respond as if the new stimuli were still present. This is what the Lamarckian theory of evolution demands. We will not say that such a thing is impossible, but it is in the highest degree improbable, and it is very difficult to conceive how such a result could be reached. At all events, no case of the supposed transmission of modifications has yet been brought forward which could not be better explained in other ways.*

The Sexual Metamorphosis.—One question of special interest in connexion with development arises from one of the earliest biotechnical inventions of mankind. Between the ages of twelve to seventeen there is more or less abrupt development of what we have already called the "secondary sexual characters" in girls and boys. The age of *puberty* may be compared to the period of metamorphosis in the frog. At puberty, so called because of the appearance of hair on the pubic region (i.e. the region where the legs join the trunk), the ovaries begin to liberate egg cells and the testes begin to manufacture seminal fluid. The development of the secondary sexual characters, e.g. bass voice and beard of the male, can be prevented by removal of the gonads, just as the metamorphosis of the frog can be prevented by removal of the thyroid glands. One result of removal of the gonads (castration) is that the individual tends to deposit fat in the tissues, for which reason castration is practised in agriculture (where a single normal male suffices to serve a large number of females). From ancient times castration was practised in cattle rearing. It was also carried out on the male of the human species. Such individuals are called eunuchs.

* *Living Organisms*. Oxford University Press.

The assumption of the most obvious differences between the sexes is correlated with the activity of the gonads in many animals, just as the loss of the larval characters is dependent on the activity of the thyroid glands in frogs, toads, and salamanders. In fowls the hen will assume the plumage and spurs of the cock, if the ovary is removed at any time in the life cycle. Male crabs attacked by the parasite *Sacculina*, develop the characteristic female configuration of the abdomen and pincers, when their testes are destroyed by the parasite. We are thus led to inquire into the factors which, in the course of development, determine whether a male or female type of gonad will be formed.

A number of facts about animals suggest the intervention of some agencies tending to predetermine the sex of the developing organism at a very early stage in development, in fact at the time of fertilization. One which was known to practical beekeepers in ancient times—indeed Aristotle attacked the belief—is that the male bee or wasp is produced from unfertilized eggs. The females (queens and workers) are produced in the usual way. This is true of the entire order of insects (Hymenoptera) in which bees and wasps are placed, and also of the minute freshwater wheel animalcules (Rotifera). In some animals the products of the first segmentation divisions separate, and several embryos are produced from one egg. When this happens, as in the production of “identical twins” in the human species, the individuals produced from a single egg are always of the same sex. The nine-banded armadillo produces litters of four or five young from a single egg. Individuals of the same brood are always of the same sex. In related species of armadillos, which produce litters from several eggs shed at once, individuals of the same litter may be either male or female.

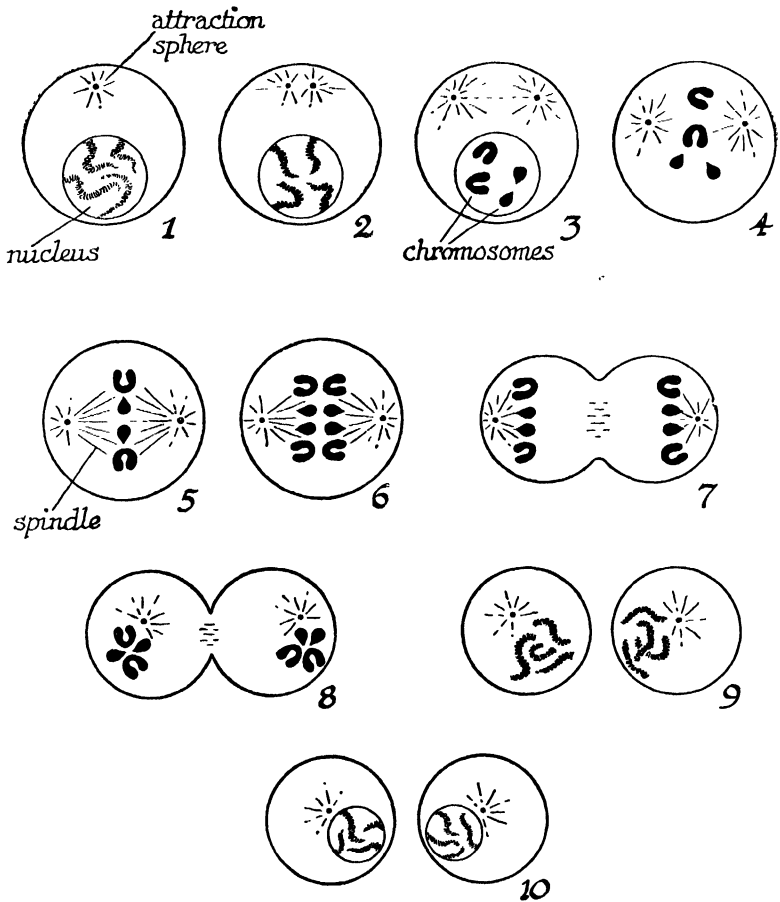

FIG. 72—CELL DIVISION BY MITOSIS

This figure shows rather schematically the chief stages of mitotic cell division in an organism with four chromosomes in each of the ordinary cells of the body. (1) Resting nucleus just before commencement of division. (2) Spindle forming and the four chromosomes distinct, each with the beginnings of a longitudinal split. (3) The spindle extends across the centre of the cell, the membrane enclosing the nucleus has disappeared, and the chromosomes are becoming short and thick. (4) The compact chromosomes lie along the equator of the cell. (5) Chromosomes separating, cell elongating. (6) Cell beginning to divide, daughter chromosomes beginning to become diffuse and to run together to form two new nuclei. (7) Cell division complete and daughter nuclei entering a new resting phase.

Clearly something which happens before segmentation begins decides the sex of the individual.

Nuclear Division.—In microscopic preparations nuclei of resting cells appear as vesicles containing a tangle of finely-spun threads. At one side of the nucleus is a small area in the cell substance, the *attraction sphere*, whose separation into two parts heralds the inception of cell division (Fig. 72). As the two attraction spheres separate they appear to draw out the surrounding cytoplasm into a *spindle* of fine fibrils. Meanwhile, changes have taken place in the nucleus itself. The tangle of fine threads has resolved itself into a number of readily distinguishable filaments called *chromosomes*, each of which is already beginning to split lengthwise into two halves. They become progressively shorter, assuming the appearance of stout rods or blocks staining deeply with certain dyes such as logwood. The chromosomes next arrange themselves on the equator of the spindle, and the halves of each chromosome separate, passing to opposite ends of the spindle. Then, while the division of the cytoplasm completes itself, they spin out again into fine threads. From these the nuclei of the daughter cells are built up.

Thus each of the chromosomes in the nucleus of any cell is structurally equivalent to a corresponding chromosome in that of the preceding and succeeding cell generations. In every species of organism the number of chromosomes which can be counted in dividing nuclei is constant, and the elaborate method just described by which nuclei divide (*mitosis*) ensures the maintenance of this constancy. The important fact that the nuclei of any one species of animals are made up of a constant number of chromosomes when the cells divide was established during the seventies.

With this discovery a new problem arose. During fertiliza-

tion, as we have seen (Fig. 4), the nucleus of the sperm unites with that of the egg to form a single nucleus of compound origin. Why does this not result in a doubling of the number of chromosomes in the nucleus in each generation?

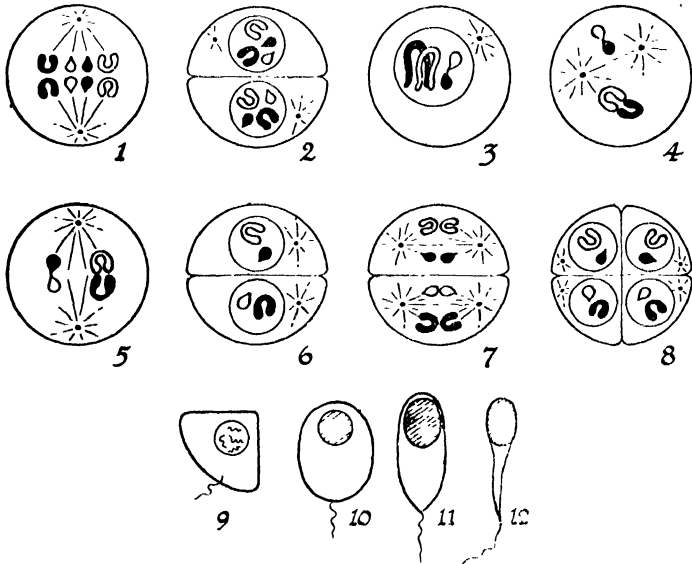

FIG. 73—REDUCTION DIVISIONS IN MALE OF A SPECIES WITH FOUR SIMILAR CHROMOSOMES, AS IN FIG. 72

(1-4) Normal division. (5-8) Reduction division. (9) (10) (11) (12) Showing transformation of a reduced cell of the testis into a sperm.

What ensures that each generation has the same chromosome number as the last? These questions can now be answered. The formation of ripe sperms or eggs is the final stage of a long process of repeated cell-division within the testes or ovaries. All of these divisions except one take place in the manner already described. The last division but one before the formation of the actual ripe gametes is peculiar (Figs. 73, 74). Just before this division, the chromosomes come to

lie side by side in pairs—a process known as *synapsis*—and during the subsequent division, when the stage corresponding to 5 of Fig. 72 is reached, it is these pairs which lie on the spindle. Instead of the chromosomes splitting in halves, as is normally the case, the pairs now part company, and one member of each pair goes into each of the daughter cells. Each of the resulting cells, and therefore (as the next division is perfectly normal) each of the gametes, has exactly

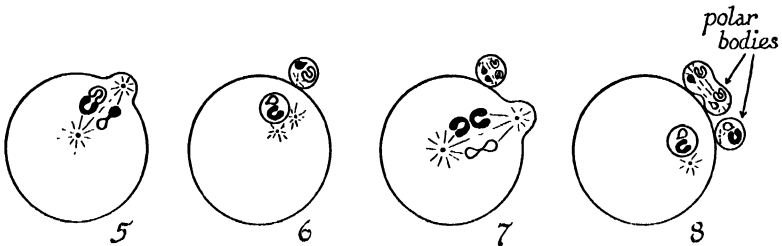

FIG. 74—REDUCTION IN THE FEMALE

The antecedent stages correspond with stages 1-4 in Fig. 73.

half the number of chromosomes characteristic of the species. At fertilization the normal number is of course restored.

So every ordinary cell of an individual organism has a chromosome set of which half the components are paternal in origin and half maternal. In both sexes the *reduction division*, as this exceptional division of the nucleus is termed, occurs in the same way. In the male it is followed by division of the rest of the cell, and each daughter cell divides again in the normal manner, so that four sperms, each with half the typical chromosome number, result (Fig. 73). In the female, although the nucleus divides twice, just as it does in the male, the rest of the cell does not divide. Only one of the four resulting nuclei is retained within the egg-cell; the other three are extruded and degenerate, constituting the so-called *polar-bodies* (Fig. 74).

In many animals and plants it is possible to distinguish, among the chromosomes, pairs of different sizes and shapes—this is the case, for instance, in the fruit-fly *Drosophila*—and it is possible to see that each gamete receives one representative of each of the four pairs of chromosomes present in ordinary cells (Fig. 79).

This fact has proved to be of first-rate significance in the

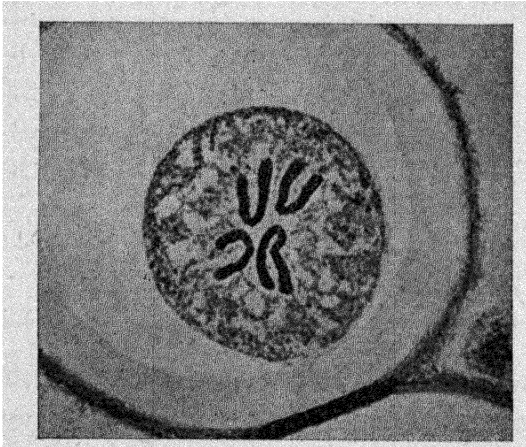

FIG. 75—MICROPHOTOGRAPH OF A DIVIDING CELL, IN STAGE 5 OF FIG. 72, SHOWING FOUR U-SHAPED CHROMOSOMES

search for a material basis for the interpretation of experiments upon inheritance. Consider as a concrete illustration, the case of the stone-fly *Perla*, as described by Nakahara (1919). In the unripe germ cells of the male (Fig. 76) the chromosome complex consists of ten elements differing *inter se* in the following way: one pair, *aa'* are rod-like and equal, two pairs, *ββ'* and *γγ'* are V-shaped and equal, one pair, *δδ'* are much smaller and spherical in contour, the fifth pair being composed of unequal rods X and Y, whose special significance will become clear at a later stage. After reduction

the sperms contain five chromosomes, viz.: a or a' , β or β' , γ or γ' , δ or δ' , X, or Y. Similarly the female gamete will contribute one member of each pair to the fertilized egg, which hence possesses five.

Thus the nucleus of the fertilized egg divides so that the daughter nuclei of the first cleavage receive two representatives of each pair of chromosomes. Cell divisions follow in rapid succession during the up-

building of the embryo. Thus each cell of an individual fruit-fly contains four pairs of chromosomes, one member of each pair derived from the father and the other from the mother. As the result of reduction each gamete receives one component of each pair, that is to say, *with respect to each pair of chromosomes the formation of the gametes involves the*

segregation of its paternal and maternal components. The Principle of Segregation we shall find later to be of the utmost significance in studying hereditary transmission.

In the fruit-fly, there is another feature which calls for further comment. This is the existence, as in many animals, of one unequally mated pair of chromosomes, the XY pair. When this occurs, it occurs in one sex only; in the alternative sex there is a corresponding equal pair (XX). In birds and Lepidoptera (butterflies and moths), the female is the XY, the male the XX individual. With sufficiently careful measurement the male is usually found in other animals to have an unequal (XY) pair which is equally mated in the female (XX).

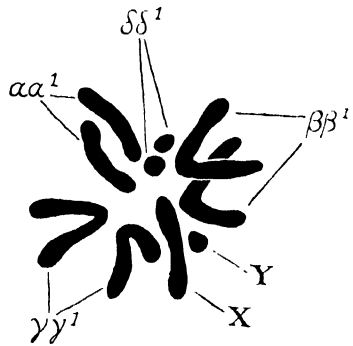

FIG. 76—CHROMOSOMES OF THE STONE-FLY

This was first noticed because some animals were found to have an odd number of chromosomes in one sex. This seemed to conflict with the numerical constancy of the chromosomes. In the early years of the present century the American zoologists provided the key to an understanding of the discrepancy. In all such cases the alternate sex has one more chromosome. The male of *Periplaneta*

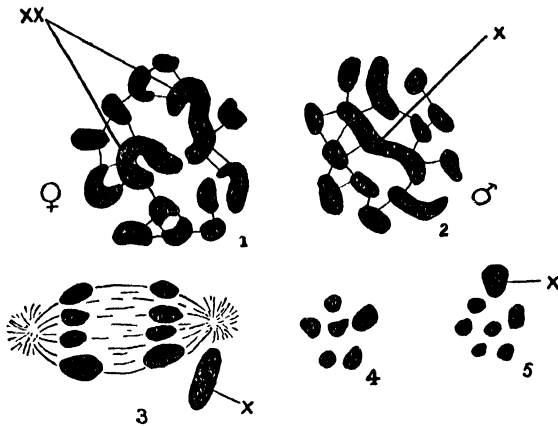

FIG. 77—CHROMOSOMES OF THE PLANT BUG PROTENOR

(1) of female; (2) of male; (3) the reduction division in the male (see (5) of Fig. 73); (4) male-determining and (5) female-determining sperms, resulting from the unequal division in (3).

americana, the large cockroach which haunts our bake-houses, has 33, the female 34 chromosomes. The eggs all have 17 chromosomes, one half of the sperm have 17, the other half 16 chromosomes. If a sperm of the former class fertilizes an egg, the individual produced will be a female ($17 + 17 = 34$), and if a sperm of the second type fertilizes an egg, the individual produced will be a male ($17 + 16 = 33$).

Similarly with the XY chromosomes. The male of the human species has 23 equal pairs and 1 unequal pair (XY)

of chromosomes in the unreduced nuclei. Thus two types of sperm are produced, X-bearing and Y-bearing respec-

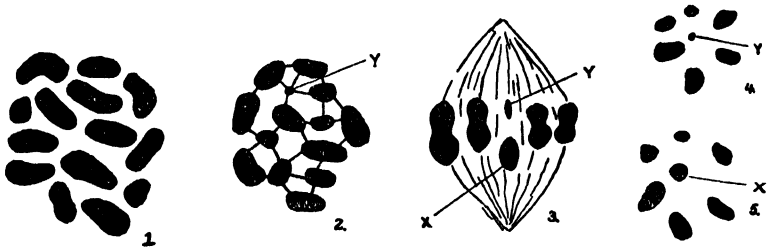

FIG. 78—CHROMOSOMES OF THE PLANT BUG EUCHIISTUS
Numbers as in Fig. 77.

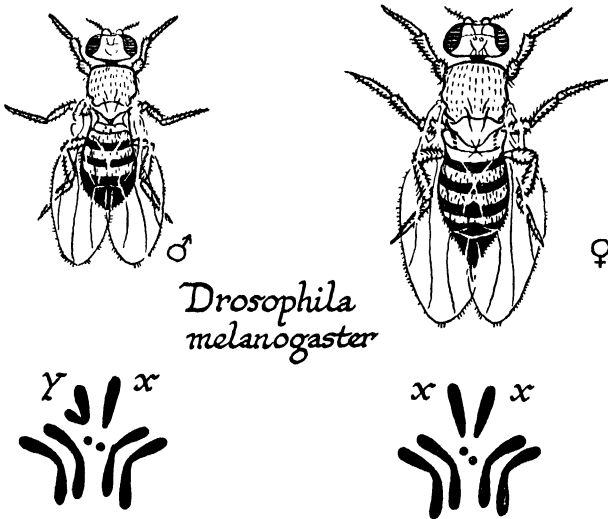

FIG. 79—THE MALE (left) AND FEMALE (right) OF THE BANANA FLY (*DROSOPHILA MELANOGASTER*) AND THEIR CHROMOSOMES

tively, the one female producing, the other male producing. The modern theory of sex determination fits in well with many biological facts, and is confirmed by two independent lines of evidence, one of which will be discussed at length

later. The other may be mentioned here. In species having an XY pair in the male, measurement of the sperm heads shows that the sperms are of two different sizes. This suggests that it may be possible eventually to separate seminal fluid into portions containing predominantly one or other type of sperm, the X-bearing or Y-bearing. If this could be done the control of the sex ratio would be experimentally realizable.

Many medical men still adhere to the superstition that the sex of human offspring depends upon whether the egg fertilized is derived from the right or left ovary. Apart from the very conclusive evidence we have from other sources that this view is wrong, it is demonstrably false in other mammals, where removal of the ovary of one side does not affect the sex ratio. In this connexion, one may pertinently recall the words of Sir Thomas Browne:

And therefore what admission we owe unto many conceptions concerning right and left requireth circumspection. That is how far we ought to rely on the remedy in Kiranides, that is the left eye of a hedgehog fried in oil to procure sleep, and the right foot of a frog in a deer's skin for gout; or that to dream of the loss of right or left tooth presageth the death of male or female kindred, according to the doctrine of Artemidorus. What verity there is in that numeral conceit in the lateral division of man by even and odd, ascribing the odd unto the right side and even unto the left; and so, by parity or imparity of letters in men's names to determine misfortunes on either side of their bodies, by which account in Greek numeration Hephæstus or Vulcan was lame in the right foot, and Annibal lost his right eye. And lastly what substance there is in that auspicial principle and fundamental doctrine of ariolation, that the left hand is ominous and that good things do pass sinistrously upon us, because the left hand of man respected the right hand of the gods, which handed their favours unto us.—(*Vulgar Errors.*)

When the sex chromosomes were first discovered the con-

clusions we have outlined seemed to conflict with the well-known fact that many familiar animals change their sex under certain conditions. But we may presume that whatever influence the X chromosome exerts requires the proper co-operation of external agencies; indeed the facts of sex transformation fit in very well with the hypothesis, now they have been studied more carefully. Crew found (1921) that, whereas the offspring of a normal mating in frogs produces the customary 1 : 1 ratio of male and female offspring, a quite different result occurs when we mate with a normal female a male that started its life as a female. He reared a generation of seven hundred offspring of such a cross, all females. If the transformed male was, as its former life would suggest, an XX individual in disguise, it could produce no Y-bearing sperm and therefore no male offspring.

TOPICS FOR HOME STUDY

1. Explain the difference between holoblastic and meroblastic segmentation by reference to *transitional* types.
2. How are the following structures formed:
 - (a) notochord.
 - (b) C.N.S.
 - (c) gut.
 - (d) placenta.
3. Illustrate how external circumstances can modify the process of development.
4. What part do ductless glands play in Amphibian metamorphosis.
5. On the assumption that the maternal and paternal components of each chromosome pair are distributed independently, show by diagrams how many different classes of gametes can be formed by reduction when there are 1, 2, 3, 4 pairs of chromosomes. In this context gametes are regarded as identical if for every pair both have two chromosomes of maternal origin, both have two chromosomes of paternal origin, or both have one maternal and one paternal component.

CHAPTER VIII

THE MACHINERY OF INHERITANCE

IN the last chapter we have studied the characteristic features of the development of a new being, and in so doing we have dwelt on the fact that the external conditions under which the fertilized egg develops have a very important influence. Thus we have been led to make a distinction between two aspects of the process. One is the nature of the conditions which affect the segmenting egg and growing embryo. The other is the kind of materials which the sperm and egg respectively contribute to the constitution of the new organism at the time of fertilization. Now it is a matter of common knowledge that if it is allowed to develop under the same conditions as the fertilized egg of one species, the fertilized egg of another species of animal will not lead to the production of the same type of adult. It is a universal experience that any dog resembles its father and mother more closely than it resembles any cat or any fish; any cat resembles its father and mother more closely than it resembles any dog or any fish; any fish resembles its father and mother more closely than it resembles any cat or any dog. We may express this by saying that cats, dogs, and fish have certain specific *hereditary* properties. If we examine these hereditary properties we find that a cat has more hereditary properties in common with any dog than those which it shares with any fish. Thus organisms can be arranged or classified in groups expressing the extent of resemblance in their hereditary properties.

The Problem of Inheritance.—Within the limits of a single

species, the differences exhibited by different individuals are not entirely due to differences of upbringing. We know that pure-bred White Leghorns separated by nothing more substantial than a thin partition of wire netting from a pen of pure-bred Buff Orpingtons will have offspring that are like their parents and not like the offspring of Buff Orpingtons.



FIG. 80—THE FIRST STUDBOOK IN HISTORY

What is probably the world's oldest chart of pedigree horses is this Mesopotamian tablet, dating from many centuries before the beginning of our era. Close scrutiny will reveal the universally adopted sign for "female ♀." (From *Modern Encyclopaedia*, Part I, by permission of The Amalgamated Press.)

We know, too, that we can anticipate with certainty the characteristics of the offspring of a "pure-bred" strain of White Leghorns, but we cannot anticipate with the same precision the characteristics of the offspring of a mixed pen of poultry. Thus a new problem faces us, if we want to decide how the characteristics of the parents affect the type of offspring produced, when the conditions of development are constant but the characteristics of the parents are different. This is the central problem of inheritance, the study of which is sometimes called *Genetics*.

The issue we have just stated is very much like another problem in science that has a somewhat similar history. It is like the problem of how two chemical reagents react together to form a new compound, and how the original constituents can be recovered when the new compound is in turn decomposed. Modern chemical theory begins with the recognition of the Principle of Conservation of matter and the discovery by Richter (1792) of the law of constant proportions. Richter's discovery led Dalton (1802) to the atomic theory of matter. We are still far from understanding the physical chemistry of inheritance, but we are to-day in a position to form a corresponding picture of the process of combination of heritable properties, as it takes place when a new unit of living matter is brought into being. Since the study of inheritance is to-day an exact science, we shall devote some detailed consideration to it in the present chapter. Our first task will be to show that there is also a law of the conservation of genetic materials and a law of constant proportions of heritable properties. These two laws can be generalized in a Principle of Segregation which is closely analogous to the Atomic Principle.

As in the study of chemistry, genetic experiments must be done with pure materials, that is stocks whose offspring we can predict, if the conditions are defined. For instance, we may mate a cock of the white variety of the Andalusian breed of poultry and a hen of the black variety—both individuals being selected from stocks which have been inbred for their characteristic plumage colour for a large number of generations, and are therefore, genetically speaking, pure materials. Their progeny will be found to be neither white nor black but intermediate between them, being slate-blue birds with feathers shading into blue-black upon the neck and

back. If these blue hybrids are mated with one another their offspring will be of three kinds—white, black, and blue—and if sufficiently large numbers of eggs are hatched the proportions will approximate to the ratio 1 : 1 : 2. Exactly similar results would follow if the original father had been a black Andalusian cock and the original mother a white hen. One thing which this shows us is that the sperm and egg, though so different in size, contribute equally to the constitution of the fertilized egg. We also learn that though the hereditary properties of both the parents seemingly disappear in the individual resulting from the combination of a particular sperm and a particular egg, they are really there but somehow hidden. In addition we find that when the parental contributions reappear they do so in definite *numerical proportions*.

Mendel's Hypothesis.—These conclusions were proved true of animals at the beginning of the present century, but they were discovered to hold good in plants nearly half a century earlier by an Austrian Abbot, Mendel (1858–65), contemporary with Darwin. Mendel first formulated the Principle of Segregation which stands in the field of genetics for the Atomic Theory in chemistry. The experimental fact which Mendel and several of his contemporaries had discovered that, when plants of different pure stocks are crossed and the offspring mated *inter se*, the pure parental types reappear in definite numerical proportions in the second crossbred generation. In seeking for a more general rule, Mendel started with two assumptions which are in keeping with observations of hereditary transmission and of the nature of fertilization:

- (a) the two parents contribute equally to the hereditary constitution of the offspring; and

- (b) there is no reason to suppose that the chance of any kind of gamete fertilizing any other kind (of the opposite sex) is influenced by anything but the numerical proportions in which they are produced.

If we take these two conclusions as granted, all the quantitative results follow from the laws of chance on the hypothesis that there are particles of hereditary combination, contributed by both parents, and so distributed among the gametes that any particular gamete contains one member—either the paternal or the maternal—of a corresponding pair. Mendel called these particles or atoms of heredity.

In the last chapter we have acquainted ourselves with material entities in the sperm and egg which do behave like Mendel's units, and the student will find it more easy to envisage what is implied by the Principle of Segregation, when we have seen how the behaviour of the chromosomes bears on the interpretation of such experiments as we have last described. But for the sake of historical perspective we shall insert a brief account of Mendel's own researches. The student may find it helpful to return to this after gaining the clearer insight which the study of the chromosomes affords us.

Mendel's hypothesis was greatly in advance of his time. His doctrine assumed the principle that fertilization is the combination of two gametes. This had not then been shown to be true of animals. He also postulated the existence of material entities for which at that time no microscopic evidence was available, because he worked long before the facts of mitosis and reduction, set forth in Chapter VII, began to be understood. When three Continental workers, de Vries, Correns and Tschermak independently redis-

covered his principles in the opening years of the twentieth century and unearthed his papers in an obscure horticultural journal, knowledge of the microscopic bodies known as the chromosomes was already sufficient to confirm the essential truth of his conclusions.

In his original work Mendel chiefly employed the common pea. This possesses two advantages which recommend it for such experimentation, namely, that its flowers are capable of self-fertilization (i.e. the pistil can be pollinated from the stamens of the same flower) and that it has a number of well-marked varieties distinguished by tangible characteristics, such as the shape (round or wrinkled) and colour (green or yellow) of the seeds, or the stature (tall or dwarf) of the shoot, etc. A single example will be easier to see how Mendel was led to the fundamental genetic principle which he discovered.

As a type of Mendelian experiment we shall consider the results of crossing a variety of pea having a dwarf shoot, from a stock breeding true to this feature, with an individual from another variety characterized by a tall shoot, likewise of pure pedigree. When pollen from flowers of the one is transferred to the stigma of the other, the same result always occurs. Every seed produced in consequence of such a union gives rise to a tall plant, whichever way the cross is made with respect to the sex of the parents. But if these seeds are allowed to germinate and grow into plants, the results of self-fertilizing the flowers of the first generation (technically the F.₁ or first filial generation of the cross), or, alternatively, crossing them with other F.₁ plants, is entirely different from the effect of crossing two of the parental pedigree tall plants. Instead of obtaining only tall plants true to type, it is found that three-quarters of the seed

produced (F.2 generation) give rise to tall plants, and one-quarter to dwarfs like one of the original parents. Further breeding shows that two-thirds of the F.2 tall individuals breed in the same way, throwing dwarfs in the same ratio. The remainder breed true to type like the original tall parent when self-fertilized, as do the dwarfs of the F.2 generation, which, when self-fertilized, or crossed *inter se*, have only dwarf offspring.

The first clue to Mendel's line of reasoning is that the hereditary constitution of the tall individual in the F.1 generation differs from that of the tall parents in so far as it is capable of giving rise to dwarf offspring. It differs presumably in producing gametes characterized by the possession of some material (Mendel called it, without discussing its nature, a factor) responsible for the production of the dwarf condition. We notice also that in the F.2 generation the proportions of pure tall and pure dwarf plants are identical, that is to say, one-quarter have the factor for tallness only and one-quarter the factor for dwarfness only, so that neither of the gametes from which an individual of either type originates contains the alternate factor. In addition we must bear in mind that the F.1 tall plants behave in a similar manner whether the factor for dwarfness is borne by the maternal or paternal gametes (ovules and pollen grains). Let us therefore suppose that each F.1 tall plant produces in equal quantities gametes bearing the tall and dwarf factors respectively—but never both—and further that there is an equal chance of any pollen grain fertilizing an ovule with the same or an alternative factor to that which it bears. It follows that the number of individuals produced in the F.2 generation containing both factors for the tall and dwarf conditions will be twice the number containing only the tall

or only the dwarf factor. For T may fertilize T or D, giving TT or DT; and D may fertilize D or T, giving DD or DT. This, of course, satisfies the conditions, and is an adequate account of the facts so far. It is the essence of Mendel's hypothesis, which states that characters distinguishing different hereditary strains depend upon factors which are inherited from both parents and *segregate* in the formation of the gametes, so that one-half contain the paternal and one-half the maternal factor.

The assumptions advanced may not involve every conceivable possibility, and the truth of the factorial hypothesis must stand or fall, like all other hypotheses, with its capacity to yield verifiable consequences. Consequences of a verifiable nature which can at once be subjected to test are exemplified by crossing back the F₁ impure tall plants with (a) the pure tall parents and (b) the dwarf plants—which are all pure. Using as before letters to denote the material factors at work, the pure breeding tall plants and dwarfs have the constitution TT, DD on the hypothesis outlined, since their character depends on factors inherited from both parents: the impure plants F₁ have the constitution TD or DT. By crossing TD with TT we should get two types of offspring TT and TD, equal numbers of pure and impure tall plants. Also by crossing TD with DD, we get two types of offspring TD and DD, equal numbers of impure tall and pure dwarf. Mendel tested and verified these and other implications; and all subsequent inquiry has confirmed the anticipations raised.

He was thus led to this conclusion. Hereditary differences are dependent upon separate particles derived from both parents, remaining distinct throughout the entire life-cycle, and finally separating in the formation of the gametes, so that with respect to any single pair of them one-half of the

gametes contain the particle derived from one parent and the other half contain the particle contributed by the alternate parent. This is Mendel's law of *genetic segregation*.

For the sake of convenience we may here introduce some necessary technical terms. An individual which like the "impure" F.₁ tall plants receives dissimilar factors from its parents is said to be *heterozygous* in respect of those factors in contradistinction to the *homozygous* (e.g. pure dwarf or pure tall) type. The character which appears to predominate, if its material forerunner is present in the fertilized egg, is said to be *dominant* in contradistinction to the *recessive* character, which is only manifest when both the gametes contribute its material forerunner.

Dominance is not a universal phenomenon. For instance, if we cross individuals from pure stocks of the red and white varieties of the flowering plant popularly known as *four o'clock* or botanically as *Mirabilis jalapa*, the F.₁ generation bear only pink flowers. If these F.₁ heterozygotes are selfed or crossed *inter se*, the F.₂ generation is composed of reds, pinks, and whites, in the proportion 1 : 2 : 1. This would correspond to the 3 : 1 ratio if the heterozygotes were similar to one or the other type of homozygote. The *blue* hybrid Andalusian fowl produced by crossing black and splashed white birds is analogous. Mating of Blue Andalusian fowls results in producing black and white offspring. Hence, if we wish to obtain blue individuals it is more profitable to mate blacks with whites. This gives us a heterozygous generation of blues only. The effect of crossing the blue heterozygotes among themselves is to raise a progeny of blacks, blues, and whites in the ratio of 1 : 2 : 1. In these examples the heterozygote is intermediate between the parental homozygous types. In the inheritance of the white colour of Leghorn fowls, we encounter an instance of what may be called in-

complete dominance; for, if mated with an individual of a coloured strain, the heterozygous individuals are white with a few coloured tail feathers. Statistical analysis in fact shows that dominance is never absolutely complete. Whatever be the degree of resemblance between the F.1 generation of a cross between pure stocks and the parental types, the factors remain distinct and recombine to produce pure parental types again in the F.2 generation.

An analogy will help the student to appreciate the question of dominance in its true perspective. Sodium and potassium yield colourless salts with most common acids, but the permanganates of both are purple in solution. The salts of copper are generally of a bluish or greenish tint in solution. In the one case the anion, in the other case the kation is the dominant factor in determining the physical property of colour. In neither case does the other component behave in any reaction with less characteristic efficacy on account of its presence being seemingly masked. So in the process of hereditary transmission the recessive factor is just as important as the dominant factor. It is only in its bodily expression that the two are differentiated.

It must not be imagined that every clear-cut characteristic which distinguishes two related forms need depend on only one factor difference. Mendel was particularly fortunate in hitting upon a form in which there exist a number of strains differing with respect to single pairs of unit factors. Had he studied, for example, the inheritance of the "walnut" type of comb which occurs in the Malay breeds of domestic fowl (Fig. 86), he would have had a more difficult problem. The "rose" comb of Wyandottes and the "pea" comb of the Indian Game breeds are each dominant to the single comb of the Leghorn, Sussex, and Rhode Island breeds. The "walnut" comb can be produced by crossing individuals

with the rose and pea types of comb. A pure individual with a walnut comb crossed with an individual from a single comb breed would give an F.₂ with walnut, rose, pea, and single combs all represented, because the walnut type differs from the single comb in respect of two pairs of factors, namely, those responsible when present alone for the pea and rose types. In the crosses which have been previously discussed, character differences in which only one pair of factors are involved have been deliberately selected for the sake of simplicity. In studying inheritance the geneticist often meets with apparently well-defined characters distinguishing two races of animals or plants which present a multiplicity of factorial differences. It can generally be shown that such apparent exceptions to the law of genetic segregation fall into line when the data are fully analysed.

The important point which emerges is that the original parental types in a cross between pure-bred parents reappear in their original purity, and in definite numerical proportions. To emphasize the latter a table of some of Mendel's crosses is given below:

MENDEL'S DATA

<i>Structure</i>	<i>Property</i>	<i>Dominant</i>	<i>Recessive</i>	<i>Ratio in F.₂</i>
Seed	Form	5,474 round	1,850 wrinkled	2·96 : 1
Reserve material in Cotyledons	Colour	6,022 yellow	2,001 grey	3·01 : 1
Seed-Coats . .	Form	822 inflated	299 wrinkled	2·95 : 1
Seed-Coats . .	Colour	705 grey	224 white	3·15 : 1
Unripe pods . .	Colour	428 green	152 yellow	2·82 : 1
Flowers	Position	651 axial	207 terminal	3·14 : 1
Stem	Length	787 tall	277 dwarf	2·84 : 1
		14,949	5,010	2·98 : 1 or 3 : 1

Side by side with this the reader may compare the following table showing the consistency of Mendel's observations in one of these crosses with those of later investigators:

<i>Investigator</i>	<i>Yellow Per cent</i>		<i>Green Per cent</i>		<i>Total</i>
	No.	%	No.	%	
Mendel, 1865	6,022	(75·05)	2,001	(24·95)	8,023
Correns, 1900	1,394	(75·47)	453	(24·53)	1,847
Tschermak, 1900	3,580	(75·05)	1,190	(24·95)	4,770
Hurst, 1904	1,310	(74·64)	445	(25·36)	1,755
Bateson, 1905	11,902	(75·30)	3,903	(24·70)	15,806
Lock, 1905	1,438	(73·67)	514	(26·33)	1,952
Darbishire, 1909	109,090	(75·09)	36,186	(24·91)	145,246
Totals	134,707	(75·09)	44,692	(24·91)	179,399

It must be remembered that the constant numerical proportions with which Mendel's first law, the law of segregation, deals are statistical fictions. Ultimately they depend on the experience known as the Law of the Constancy of Great Numbers, and our conclusions must bear the scrutiny of the mathematical requirements of the theory of error which is founded on it. If the fixed ratio is 3 : 1, the assumptions made are (a) that, when two kinds of egg or sperm are formed by a heterozygous individual, there should be an equal chance of any egg being fertilized by either of two sorts of sperm (that carrying the maternal and that carrying the paternal factor); (b) there is an equal chance that any sperm will fertilize one or the other type of egg. On this assumption the 3 : 1 ratio follows, if one of the parental characters is dominant. But since the assumption itself involves the idea of *chance* the conclusion is subject to the laws of chance. Obviously we cannot get a 3 : 1 ratio from a litter of three kittens. In experiments on inheritance in a common South African species of bean weevil, Dr. Skaife

crossed the dominant black form with a red recessive mutant, and obtained in the second crossbred generation 347 black and 119 red individuals. For this number of individuals the 3 : 1 ratio requires two classes differing from 349.5 and 116.5 by a "probable error" of approximately 6. That is to say, it is as likely as not that the actual figures will exceed or fall short of these numbers by 6. The observed figures differed by much less than the probable error. An exposition of the methods used in determining the probable error of Mendelian ratios lies outside the scope of this book.

Mendel's investigations followed up what happens when two different pairs of characters, each dependent on a separate pair of factors, are involved in a cross between pure-bred parents. The actual results of a cross between a strain of peas with green wrinkled seeds and yellow round seeds or of peas with green round and yellow wrinkled seed respectively will be understood by referring to Fig. 82. The ratios of the double dominant, the two classes of single dominants and the double recessives which Mendel obtained in all his crosses was 9 : 3 : 3 : 1, as should occur if the yellow-green factors and the round-wrinkled factors behave quite independently of one another. Mendel formulated this result as a generalization sometimes known as Mendel's Second Law. It is not, however, a law in the same sense as Mendel's First Law, of *segregation*, which we have deduced above, for it is only applicable to certain cases, and as we shall see later, the exceptions are of more theoretical interest than the rule. Here again an analogy from chemistry will help. The fundamental law of chemical combination is the law of constant proportions. The law of multiple proportions is no more than a statement of certain experiences that the pioneers of chemistry encountered in dealing with some of

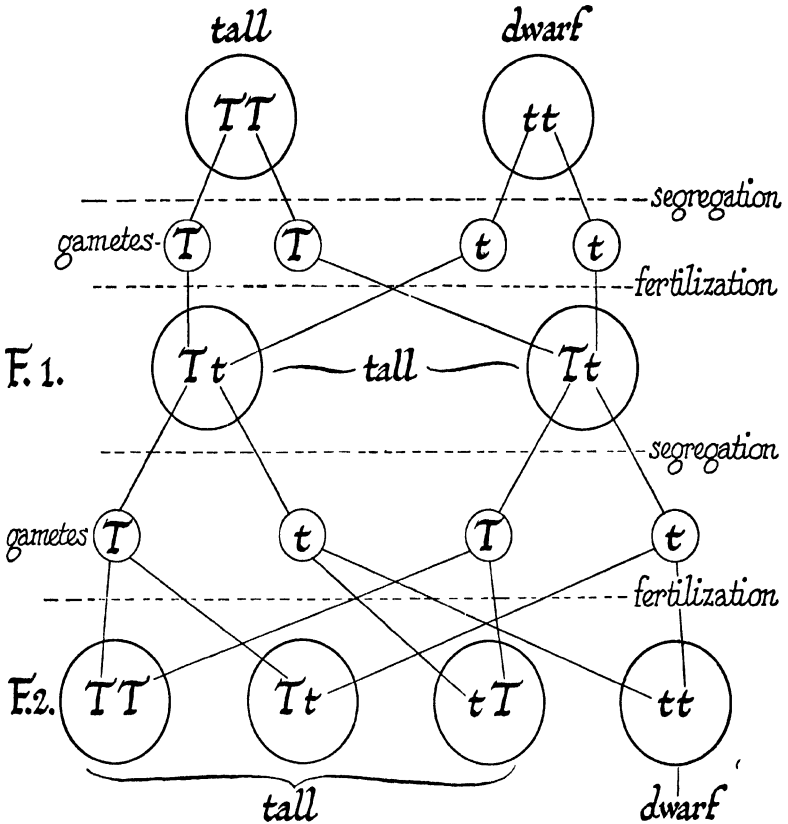

FIG. 81—MENDEL'S HYPOTHESIS

Each cell of a pure tall pea has two *particles* which are responsible for the difference between it and a dwarf one. Each cell of a pure dwarf pea has two *particles* which are responsible for the difference between it and a tall one. Mendel called these particles "factors." In the formation of the gametes, the members of each pair segregate. So each gamete contains only one member of this pair, T in the case of the tall plant, and t in the case of the dwarf plant. Fertilization yields only one kind of fertilized egg cell (Tt). This develops into a tall plant. For this reason T is said to be *dominant*, and t *recessive*. At each cell division of the developing plant, the factors divide as well. So every ordinary cell of the hybrid contains the Tt pair of dissimilar factors. In the formation of the gametes of the hybrid, however, segregation again occurs. Hence gametes containing T and ones containing t are produced in equal numbers. Random fertilization yields three classes of offspring—25 per cent pure tall (TT), 50 per cent impure tall (Tt), and 25 per cent pure dwarf (tt).

the compounds that were first investigated. Had they started with the higher hydrocarbons, they would have encountered no such simple relations. Both the law of multiple proportions and the second law of Mendel are historically important, because they helped to suggest hypotheses which, once stated, were broad enough to take in other possibilities. We shall leave a consideration of the 9 : 3 : 3 : 1 ratio of Mendel's original experiments till a later stage, and now approach the problem of hybridization from a different point of view.

The Chromosome Hypothesis.—Mendel spoke of *factors* which determine the characters which organisms display under appropriate environmental influences. All that is meant by heredity must refer to the contributions which the sperm and the egg make to the new individual. Can we go farther and identify within the sperm or egg the material particles which enter the gametes after innumerable cell divisions? Can we detect the existence of anything which behaves as our "factors" have been seen to behave?

Hybridization experiments lead us to conclude that the particles of heredity are present in the fertilized egg in duplicate, and that they segregate before the formation of the gametes into maternal and paternal components, one member of each pair and one only being present in each gamete. We now know that the number of chromosomes of any species of animals or plants is twice the number present in the gametes. In many animals (and plants) from the most diverse phyla, the chromosome complex of a species has a definite configuration as well as a definite number. Among the chromosomes it is possible to distinguish pairs of different sizes and shapes (e.g. Fig. 76), and the maintenance of this constant configuration implies that when reduction takes place one member of each pair passes into

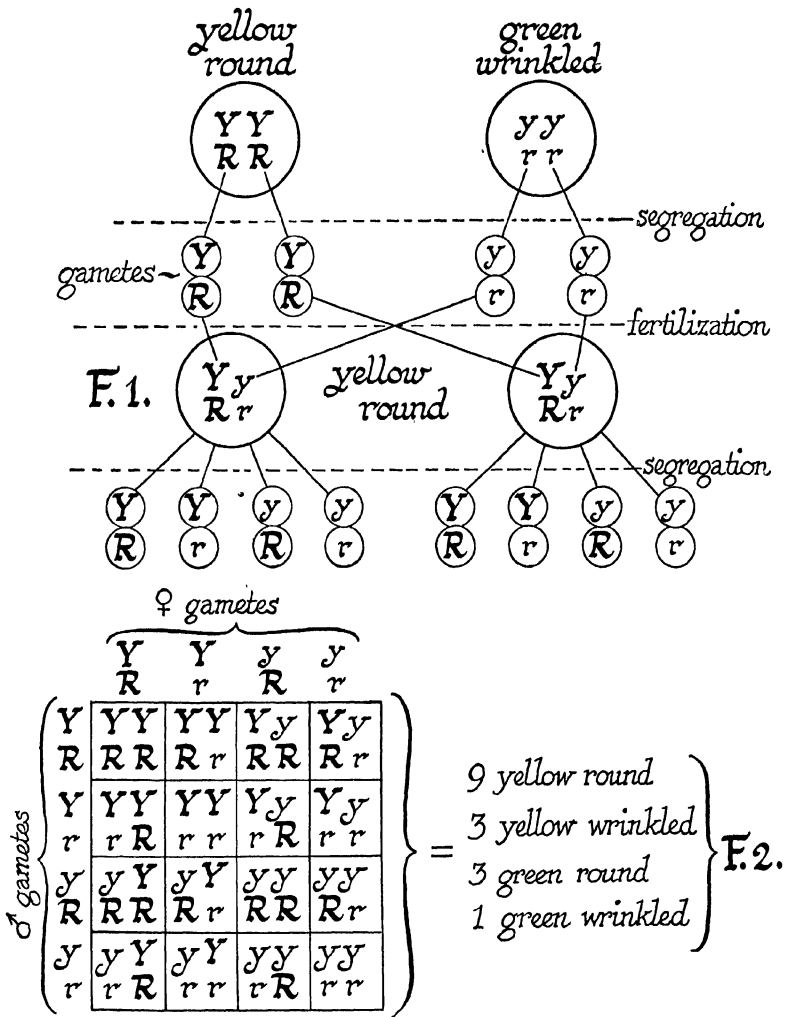

FIG. 82.—INDEPENDENT ASSORTMENT OF TWO PAIRS OF FACTORS

Hybrids represented by the genetic formula $YyRr$ can be produced by crossing the double dominant with the double recessive, or alternatively by crossing $YYrr$ with $yyRR$. The F_1 hybrid produced the four classes of gametes shown in equal numbers. This is because the assortment of factors in segregation is random in this case, i.e. it is just as likely that Y will go into the same gamete as r , as that Y will go into the same gamete as R . The results of random fertilization of the four classes of female gametes by the four classes of male gametes, are shown in the chessboard diagram,

each gamete (p. 178). In other words, the chromosomes are present in the fertilized egg in pairs, and they segregate in

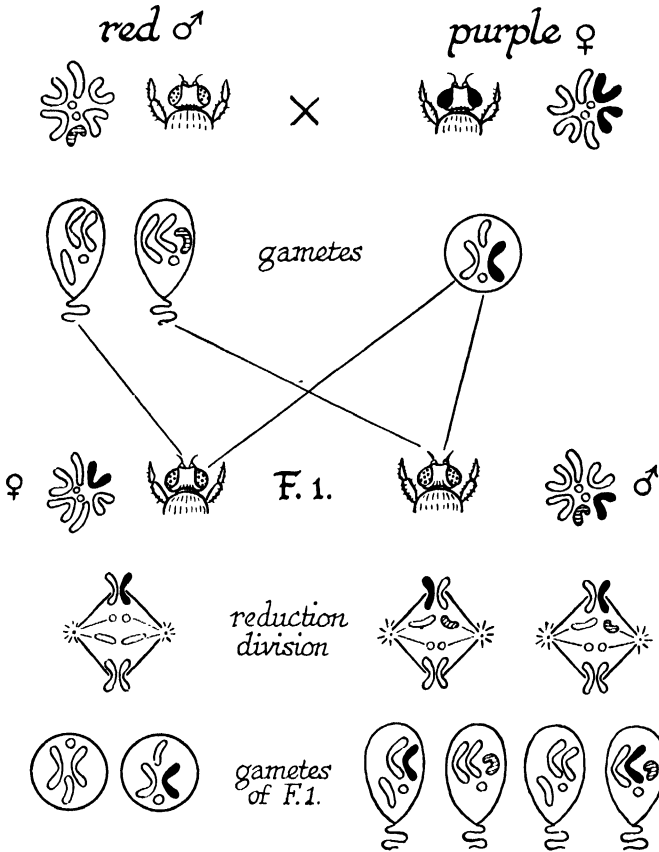

FIG. 83a

Diagrammatic representation of the first generation of a cross between the red-eyed wild type of the fruit fly and the purple-eyed mutant. The Y chromosome is shaded, and the chromosome bearing the mutant gene is shown in black.

the formation of the gametes into paternal and maternal components, only one member of each pair being represented

in each gamete. The identification of the chromosomes as the material basis of hybrid segregation immensely simplifies

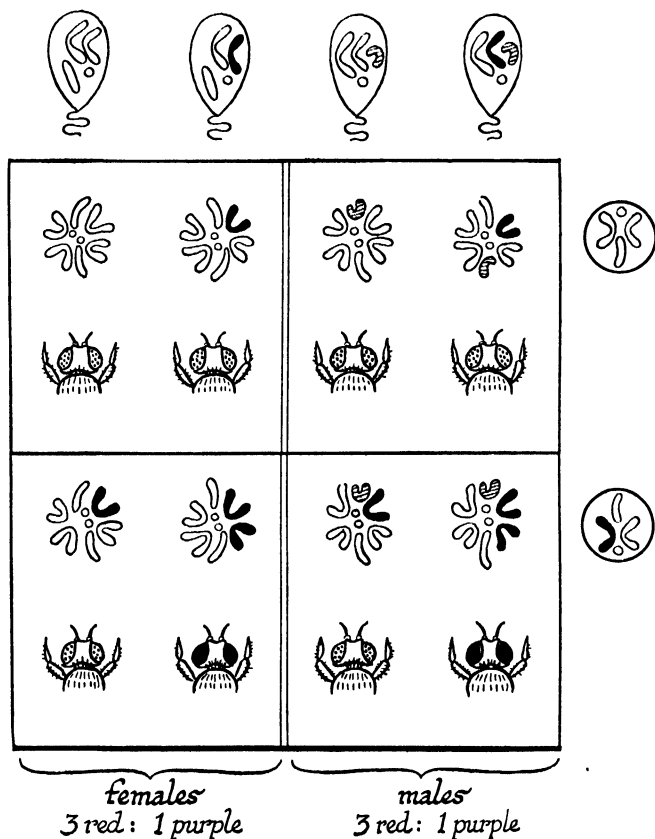

FIG. 83b

Continuation of Fig. 83a, showing the numerical consequences of mating the first cross-bred generation of flies *inter se*.

the deeper study of genetical phenomena. The most striking advances which have been made of recent years in the study of inheritance are the outcome of discovering this correspondence.

The application of Mendel's principles to animals was first made (1902) by Bateson and Cuenot independently. In the same year Sutton's work showed the correspondence between the behaviour of chromosomes and the material entities which Mendel had postulated as the basis of bi-parental inheritance. In 1911 Morgan, Muller, and Bridges at Columbia University, New York, began a series of investigations on *Drosophila melanogaster*, the fruit fly or banana fly. This little creature has almost every conceivable advantage for the purposes of genetical investigation. It is prolific. It passes through its entire life cycle in little over a week. It is eminently viable. It is easily cultured, and can be fed on rotting banana skins. It has only four pairs of chromosomes, all recognizably different. With *Drosophila* one can do more in a year than could be achieved with cattle in several centuries.

In the Columbia cultures more than eight hundred mutants or sports have appeared, and these mutants or sports, when mated with their like, breed true to type. Thus the interrelation of the mutant characters in their mode of inheritance has been studied with a thoroughness that has no parallel in genetical investigation. To illustrate the more concrete interpretation which the chromosome hypothesis affords, let us take a cross between one of the mutants of *Drosophila* and the pure wild type. The normal, i.e. wild type, fruit fly has red eyes. One variety which has appeared as a sport is distinguished by its purple eyes. When a purple-eyed mutant is crossed to a wild type individual of pure stock all the F₁ generation are red-eyed (Fig. 83a). These red-eyed individuals, when mated among themselves, produce offspring of which one-quarter are purple-eyed and three-quarters are red-eyed. If we mate the hybrids with purple-

eyed mutants, half of their offspring are purple-eyed and half are red-eyed.

Let us now suppose that the purple-eyed form originally arose because a sudden change took place in one pair of chromosomes. The individuals of the first filial generation (F.1) of our original cross will receive one chromosome of this pair from the purple-eyed parent and the other chromosome of the same pair from the wild type parent. So the first filial generation will consist of individuals which possess one pair of chromosomes the two constituents of which are not the same, i.e. a pair of which one member has undergone the change referred to and one member has not. From the result it is evident that an individual will not be purple-eyed unless both members of this particular pair have undergone the change. When reduction (p. 202) occurs in the germ cells of the cross-bred flies, a member of this pair carrying the purple-eyed gene will go to one pole and to the other pole an unmodified chromosome of the same pair. So this pair of chromosomes will be represented in one-half of the ripe sperm of the male hybrids by a member that has undergone the change and in the other half by a member that has not.

The same will be true of the eggs produced by hybrid females. If fertilization occurs at random, a sperm which possesses the mutant chromosome will have an equal chance of fertilizing an egg which has it or an egg which lacks it. For every sperm which has the mutant chromosome there will be one in which this particular pair is represented by an unmodified chromosome. Sperms of this type will also have an equal chance to fertilize an egg which has the mutant chromosome or an egg which has not. For every fertilized egg which gets a mutant chromosome both from its mother and from its father, there will be one which gets a mutant

chromosome from neither, one which gets a mutant chromosome only from its mother, and one which gets a mutant chromosome only from its father. Since an individual has purple eyes only if it gets the mutant chromosome from both parents, this makes the proportion of purple-eyed individuals in the F₂ one-quarter. With the aid of the accompanying diagrams you can deduce for yourself the consequences of other types of cross (cf. Figs. 83*a* and *b*).

Consider now a cross in which two mutant characters are involved. Wild fruit flies are grey in colour and the wings extend beyond the tip of the abdomen. Among the sports of *Drosophila* are two respectively distinguished by dark body colour and a vestigial condition of the wings. As a matter of fact, there are several mutants of *Drosophila* which have a dark body colour. The one we shall deal with here is called *ebony*. When either of these sports are crossed to pure wild type flies, the first crossbred generation are wild type. Mated *inter se*, the hybrids in either case yield progeny one-quarter of which are of the mutant type. Both mutants are therefore recessive to the respective wild types.

When the *ebony* mutant is crossed to the vestigial-winged type (for brevity "vestigial") the double hybrids of the first generation are also uniformly wild type (Fig. 84). If sufficient offspring are bred from crosses between these double hybrids, approximately one-sixteenth show both mutant characters, three-sixteenths are *ebony*, three-sixteenths are vestigial, and nine-sixteenths wild type. Figs. 84 and 85 show how this numerical result follows from the simple assumption that the change which started the *ebony* condition occurred on a different pair of chromosomes from that on which the change which originated the vestigial

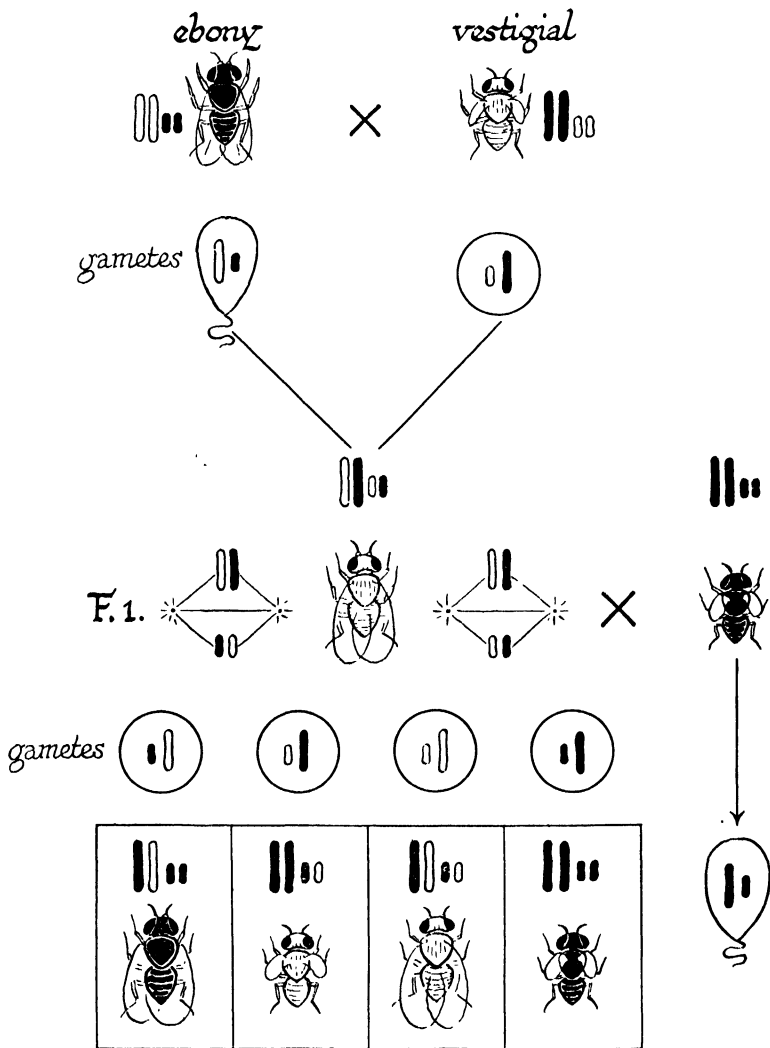

FIG. 84—CROSS BETWEEN THE “EBONY” AND “VESTIGIAL” MUTANTS OF THE BANANA FLY

The F.1 flies are crossed back to the double recessive type.

type occurred. In the reduction division of the germ cells of the F_1 generation there will be two different configurations according as the mutant members of each pair go to the same or opposite poles, and the numerical recombina-

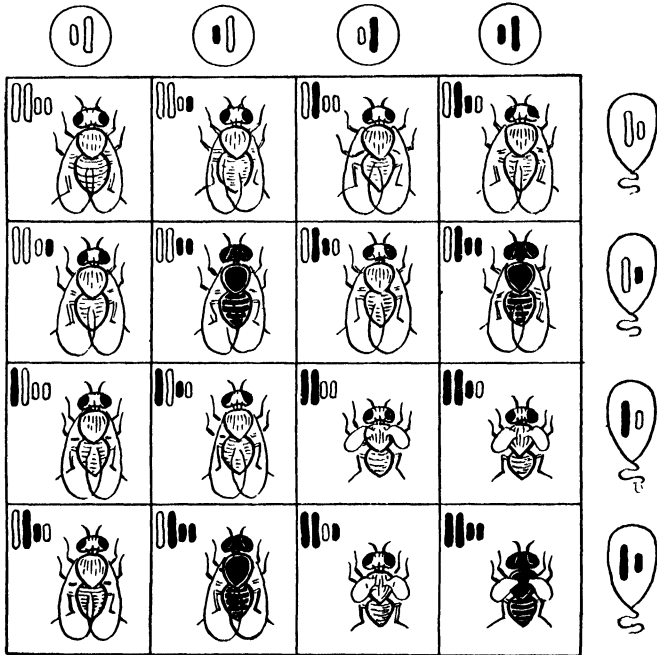

FIG. 85—RESULT OF MATING FIRST HYBRID GENERATION OF THE EBONY-VESTIGIAL CROSS OF FIG. 84 *inter se* (cf. text)

tions can be simply deduced by using a chessboard diagram to show that for every set of four different types of eggs fertilized by one of the four different types of sperm there will be a corresponding quartette fertilized by each of the remaining three types of sperm. If the double hybrid flies are bred with the new type having both mutant characters, the four possible combinations will appear in the progeny in equal proportions (Fig. 85).

This gives you the clue to the inheritance of the walnut comb of fowls. In poultry there are a large number of types of comb. The inheritance of four of them has been mentioned (Fig. 86). These are the rose comb of the Hamburgs and Wyandottes, the pea comb of the Cochins, the walnut of the Malays, and the single comb of the Leghorns and other

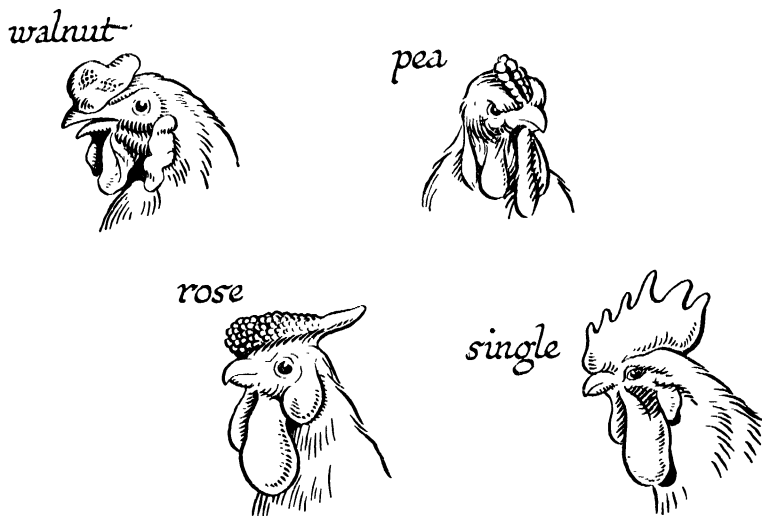

FIG. 86—FOUR DIFFERENT TYPES OF COMB IN THE DOMESTIC FOWL

Mediterranean breeds. The difference between pea and single or between rose and single affects one pair of chromosomes only. That is to say, rose by single gives an F.1 all rose and an F.2 of rose and single in the ratio of 3 : 1. Similarly with pea and single, pea being dominant. If pure-bred walnut-combed fowls are crossed with singles, the F.1 are all walnut type, the F.2 are walnut, rose, pea, and single in the proportions 9 : 3 : 3 : 1. The same result follows a cross between pure rose and pure pea. The single-

combed condition may be taken as the wild type, and the walnut type has arisen by mutant changes affecting two pairs of chromosomes. A change affecting one pair by itself produces the pea condition, and a change affecting the other pair by itself produces the rose condition. Here, it is to be noted, both mutant changes are dominant, i.e. the mutant character is exhibited if only a single member of the modified pair of chromosomes involved is present. You can illustrate this result for yourself with the aid of a diagram like Figs. 84 or 85.

The numerical results of experiments like those of Mendel thus receive a simple explanation on the assumption that the chromosomes are the seat of those changes which lead to the appearance of individuals with new heritable properties. Further experiments have made it possible to show: (1) that the material particle or *gene* responsible for the appearance of a new heritable property can be identified with a particular chromosome; and (2) that it can be identified with a definite position or *locus* on a particular chromosome.

In everything about which we have concerned ourselves so far it is a matter of complete indifference whether the character with which we are dealing is introduced from the maternal or paternal side. We also know that one pair of chromosomes is unequally mated in one sex. So any change which started on this pair is not symmetrically distributed among the sexes. In *Drosophila* (Fig. 79) the female has one pair of chromosomes (the first pair or XX) represented in the male by one element (X) of similar dimensions and another (Y) of different shape. Thus only half the sperms will carry an X chromosome. Among the mutants of *Drosophila* there is a large class—more than a hundred—which do not behave like those with purple eyes, vestigial wings, or

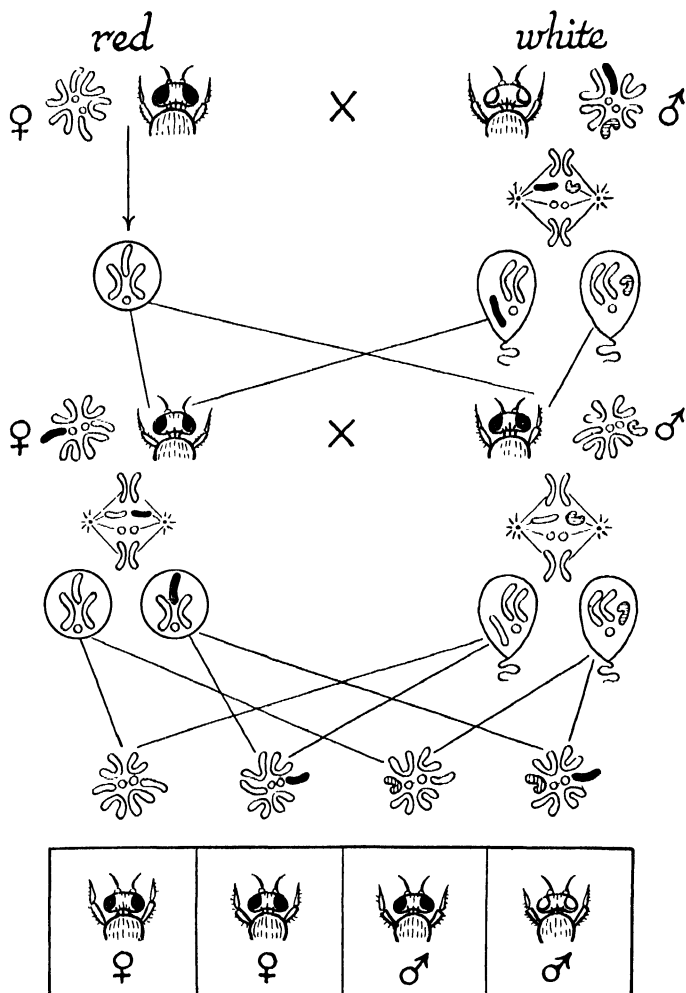

FIG. 87—SEX-LINKED INHERITANCE IN DROSOPHILA

The male of the mutant stock with white eyes mated with a wild type red-eyed female gives an F₁ all-red-eyed; in the F₂ only males are white-eyed. The X chromosome bearing the mutant factor is shown in black, and the Y chromosome is shaded.

ebony body colour. Crosses with wild type give different results according as the mutant character is introduced from the maternal or paternal side.

One example of this class has white instead of red eyes. Crossed to pure-bred wild type (red-eyed) females, white-eyed males produce offspring all of which are wild type, and when the hybrids are mated *inter se* one-quarter of their progeny are white-eyed (Fig 88). The only anomaly is that all the F₂ white-eyed flies are males. When white-eyed females are crossed to pure stock wild type males, the result is more remarkable. Only the female offspring of the first generation are red-eyed. The males are white-eyed. When these crossbred flies are mated *inter se* one-quarter of their progeny are white-eyed males, one-quarter white-eyed females, one-quarter red-eyed males, and one-quarter red-eyed females. We can interpret this result if we assume that the mutant gene which is responsible for white eyes is given on the X chromosome, and that it can override the effect of all the other chromosomes unless it is paired off with another X chromosome from wild stock. If a mutant X chromosome is present in the male there can be no X chromosome to pair with it. So the mutant condition will always be exhibited. The mutant condition will not be exhibited by the female unless both members of the X pair carry the mutant gene.

The phenomenon of "sex-linked inheritance," as this asymmetrical type of transmission is sometimes called, was first discovered by Doncaster (1906) in moths. In Lepidoptera the male is the XX type and the female XY or XO. In the currant or magpie moth *Abraxas*, there is a pale-winged (lacticolor) mutant in contradistinction to the dark-winged (grossulariata) type. Doncaster set out to find why females

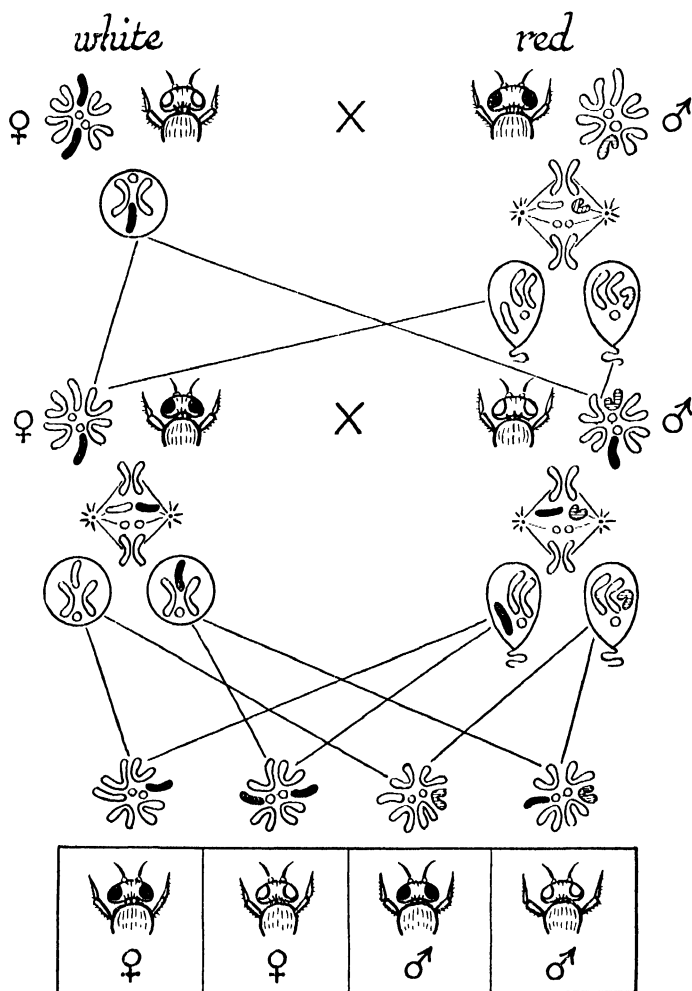

FIG. 88—SEX-LINKED INHERITANCE IN DROSOPHILA

The reciprocal cross to that shown in Fig. 87. When pure red-eyed males are crossed to white-eyed females the male offspring are white-eyed, and in the F₂ the red-eyed and white-eyed types are present in equal numbers in both sexes.

of the lacticolor variety are much commoner than males. On breeding he found that dark-winged males crossed to pale females have only dark-winged offspring, which give dark-winged and pale moths in the ratio 3 : 1 when mated *inter se*. All the pale moths of this cross are females. In the reciprocal cross only the males are of the dark type, and the F₂ is composed of dark and pale, males and females, in equal proportions. Bearing in mind the difference (p. 181) between the chromosomes of moths and *Drosophila* you will have no difficulty in applying the methods of Figs. 87–88 to interpret this result. An analogous type of sex-linked inheritance occurs in birds (canaries, poultry, etc.), as, for instance, in the dominant X-borne mutant gene responsible for the barring of the plumage in the Plymouth Rock breed.

Agreement between genetical experiment and microscopic observation is also illustrated by the phenomenon of *non-disjunction* described by Bridges in connexion with several sex-linked mutant characters of which our original mutant character (white-eye colour) will serve as an example. There appeared among the white-eyed mutant stock of *Drosophila* certain strains of which the females, when crossed to normal red-eyed males, gave a certain proportion of red-eyed males and white-eyed females, in addition to the usual red-eyed females and white-eyed males alone. When the white-eyed female offspring of such abnormal matings were crossed back to red-eyed males they, in their turn, gave all four classes—red-eyed males and females, white-eyed males and females. The white-eyed females behaved like their mothers, giving abnormal results in all cases. Certain of the red-eyed females gave normal and others abnormal results in crossing. Of the male progeny the red-eyed individuals were normal, whereas only half the white-eyed individuals were normal,

the remainder begetting daughters whose progeny was exceptional. Bridges found that in the abnormal white-eyed F.₁ females the chromosome complex of the dividing body-cells was also abnormal—it showed a Y element in addition to the XX pair.

Microscopic observation shows that in rare circumstances the X chromosomes fail to separate when reduction occurs. So the ripe egg may contain either two X chromosomes or none at all. If we represent the sperms of a red male as X' of Y, two additional types of individuals will result from fertilization by a Y or X' sperm respectively, an XXY or white female, and X'O or red male. This accounts for the exceptional individuals in the F.₁, and accords with the facts observed. According to whether the X elements segregate with respect to one another or the Y chromosome, the F.₁ white females will have four types of eggs—XX, Y, XY, X. If these are fertilized by a Y sperm (which does not influence red-eye colour) we get four types—(a) XXY white females, which will obviously behave in the same way, thus agreeing with breeding experience; (b) YY—individuals with this constitution cannot live; (c) XYY—white males which should produce XY sperms so that in crossing with normal white females daughters of the XXY type, producing exceptional progeny, would result; (d) XY—normal white males. When the same four classes of eggs are fertilized by an X' sperm carrying the red factor, four red types of offspring would result, as follows: (a) X'XX—triploid (X) female which usually dies; (b) X'Y—normal red males; (c) X'YX—red females with abnormal offspring; (d) X'X—normal red females. Thus the non-disjunction of the X chromosome in the formation of the eggs of some of the females of the parental white-eyed stock accounts for the entire series

of exceptional genetic phenomena which occur in these strains.

The Chromosome Map.—Such evidence can leave very little doubt about the conclusion that the behaviour of the chromosomes provides the material basis of the numerical proportions found in breeding experiments. There is now abundant evidence of the same kind derived from the study of inheritance in widely different types of animals and plants pointing to the same conclusion. Other experiments have made it possible to locate the changes which are responsible for particular mutant characters on a definite region of a particular chromosome.

The experimental results which lead to this conclusion may first be illustrated by what happens in crosses which involve more than one sex-linked mutant character. There is a yellow-bodied mutant of the fruit fly which behaves, when crossed to wild stock, in a manner analogous to the white-eyed form. That is to say, the yellow females crossed to pure wild stock males give yellow males and grey females, and yellow males mated to pure wild type females give all grey offspring. If we cross a yellow female with white eyes with a pure stock wild type male, the female offspring are wild type, but the males are yellow with white eyes, as we should expect (Fig. 89). When these are interbred an unexpected result occurs. A small but definite proportion of yellow individuals with red eyes and grey individuals with white eyes occurs. Since the two properties are separable we can only conclude that the same part of the chromosome is not involved in whatever is responsible for the yellow mutant on the one hand and the white-eyed mutant on the other. The numerical proportions in this case are approximately as follows;

			<i>Per cent</i>
FEMALES:	Wild type	24·725
	Yellow-white	24·725
	Grey-white	0·275
	Yellow-red	0·275
MALES:	Wild type	24·725
	Yellow-white	24·725
	Grey-white	0·275
	Yellow-red	0·275

We can also make a cross involving these two characters in a different way, as when we mate a yellow male and a white-eyed female. The first generation consists of white-eyed males and wild type females. When bred *inter se* these give offspring of all four types:

			<i>Per cent</i>
FEMALES:	Wild type	25
	White-eyed	25
MALES:	Yellow	24·725
	White	24·725
	Yellow-white	0·275
	Wild type	0·275

Inspection of the figures for the males in these two crosses shows that the extent (1·1 per cent) to which the yellow and white mutant genes get *detached*, when they are introduced from the *same* parent, is numerically equivalent to the extent (1·1 per cent) to which they tend to *come together*, when they are introduced in the first place from *different* parents. In a fixed proportion of reduction divisions the two points or *loci*, A and B, where the mutant genes are respectively located, become interchanged in the two members of the X pair of chromosomes (Fig. 90). This is in agreement with microscopic observation. In the pairing (*synapsis*) before the reduction division, corresponding chromosomes become twisted, and since the split takes place longitudinally, appear-

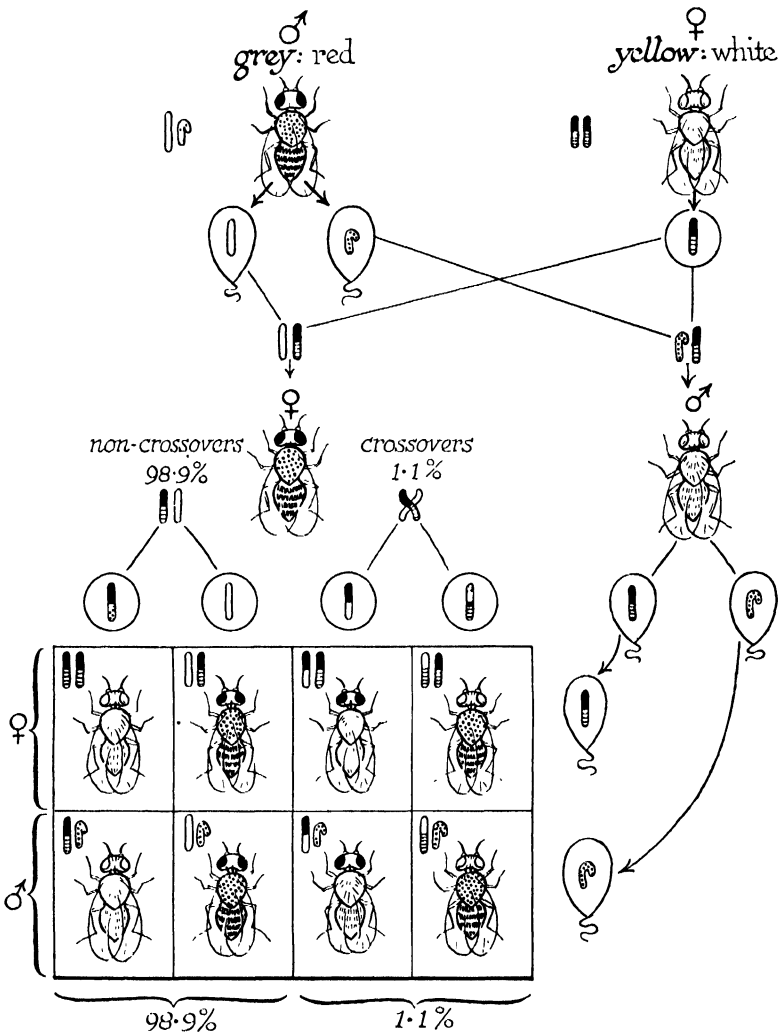

FIG. 89—CROSSING OVER BETWEEN TWO SEX-LINKED MUTANT FACTORS

The part of the X chromosome containing the gene for yellow body is shown in black and the part containing the gene for white eyes is shaded. The normal X chromosome is left white and the Y chromosome is hooked and stippled.

ances suggest that a crossing over of corresponding segments occurs. Closely neighbouring regions are less likely to get interchanged than regions farther apart, so if the gene has a definite locus on the chromosome, we should expect that genes located in closely adjacent parts would tend to stick together more often than genes whose loci lie farther apart.

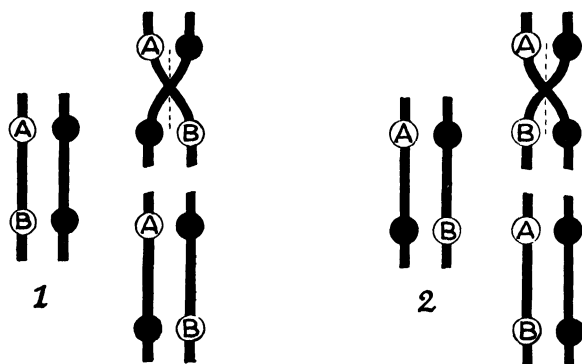

FIG. 90—DIAGRAM TO EXPLAIN CROSSING OVER BETWEEN TWO LOCI ON A CHROMOSOME

- (1) In the cross between yellow, white-eyed female and wild-type male.
- (2) In the cross between yellow male and white-eyed female.

The consequences of this conclusion can best be seen with a diagram (Fig. 93). If A B C are three points on the length of a chromosome, and B is intermediate between A and C, crossing over between the points A and C may take place in one of two ways. The length on which C is located may be displaced with reference to A carrying B with it, or the length on which C is located may be displaced with reference to A not carrying B with it. The first case involves the crossing over of the loci of A and B. The second involves transposition of the loci of B and C. Hence if the three points are located in the order stated the number

of cases in which the loci of A and C are transposed will be the *sum* of the number of cases in which A and B cross over and B and C cross over. If the order of A B C is not given, the amount of crossing over between A and C may be the *sum or difference* of the cross over A-B and B-C.

Let us now see how this applies to the example just given. Crossing over takes place between the locus of yellow and the locus of white in 1·1 per cent of the reduction divisions in the formation of the eggs. There is another sex-linked mutant characterized by possession of wings which do not extend beyond the tip of the abdomen. It is referred to as *miniature*. In yellow miniature matings which produce a very large generation of flies, the cross-over percentage (cross-over value or C.O.V.) is found to be 34·3, and in the white miniature cross the C.O.V. is 33·2. The difference 1·1 corresponds to the cross-over value for yellow and white. Thus the locus of white lies between the locus of yellow and miniature 1·1 units of length from the former and 33·2 units from the latter. This relation holds good for all the sex-linked mutant genes of *Drosophila*. So it is possible to construct, as Morgan and his collaborators have done, a map (Fig. 94) of the X-chromosome.

Thus far we have confined our attention to one group of mutant characters which have their origin in changes which occur at definite loci on the X or first pair of chromosomes in *Drosophila*. Now *Drosophila* has four pairs of chromosomes, all of which have been mapped out on the same principle. All that we have learned about the other chromosomes so far is that the genes for vestigial, ebony, and purple eye are not on the first (X) pair, and that ebony and vestigial are not on the same pair. Besides ebony there is another dark-coloured mutant which is referred to as

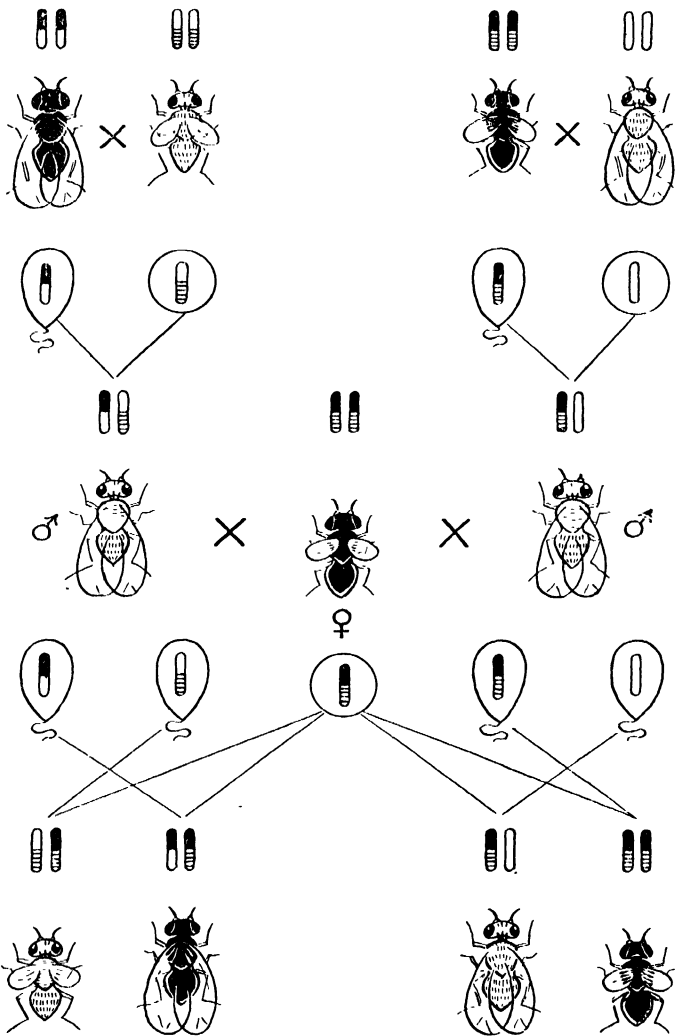

FIG. 91—LINKAGE IN A NON-SEX-LINKED CROSS

Effect of back-crossing to the double recessive female, the male offspring of a black X vestigial mating. The region of a chromosome containing a black gene is shown in black, the part containing a vestigial gene is shaded, and the parts containing the genes for grey and long are left white. On the left the black and vestigial genes entered from opposite parents, and on the right they came together. In mating the males from either cross with the double recessive female, the original linkages appear unaltered in the offspring. Compare Fig. 92.

black. When a "black" fly with vestigial wings is crossed back to the wild parent stock, the F.₁ individuals are grey with long wings as in the ebony vestigial cross (Fig. 91, right). If the F.₁ males are mated with females of the black vestigial type, the entire progeny are either grey with long wings or black with vestigial wings (1 : 1). A different result is obtained in the F.₂ generation of a cross between a black mutant with normal long wings and a grey fly with vestigial wings (Fig. 91, left). As before, the hybrid progeny are grey with long wings. If these F.₁ males are crossed back to the black vestigial females, half the offspring are grey with vestigial wings and half of them are black with long wings. The results of both crosses can be interpreted as before, if we assume that we are dealing with mutant genes located on the *same* pair of chromosomes.

This conclusion is reinforced by further experiments. If instead of crossing back the F.₁ males to the double recessive females, we make the reciprocal mating of the F.₁ females to the double recessive male type, the result is slightly different. What happens when both the recessive genes (black and vestigial) are brought in from the same parent, is that the back cross of the F.₁ females to double mutant males produces 41·5 per cent black vestigial and 41·5 per cent grey long, together with 8·5 per cent black long and 8·5 per cent grey vestigial. If the F.₁ females of a cross in which only one recessive gene is introduced by each parent (Fig. 92) are crossed back to the double recessive male, the progeny, instead of being 50 per cent black long and 50 per cent grey vestigial, are 41·5 per cent black long and 41·5 per cent grey vestigial, together with 8·5 per cent black vestigial and 8·5 per cent grey long. The numerical results can be explained by saying

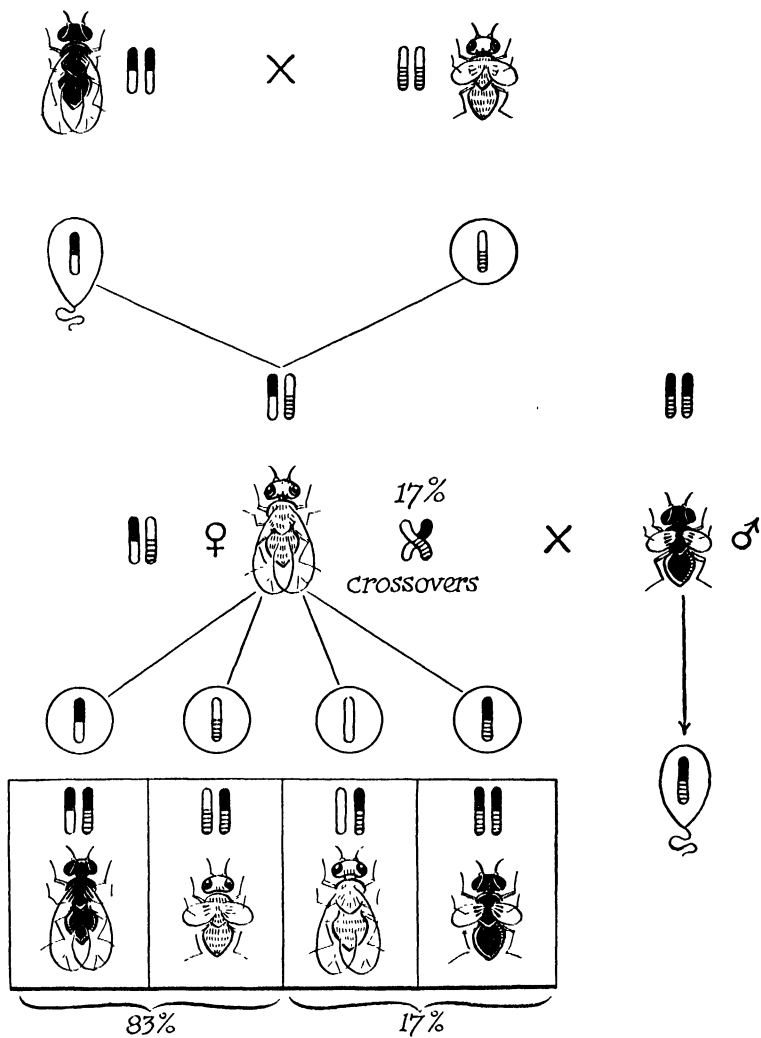

FIG. 92—CROSSING OVER IN THE BLACK-VESTIGIAL CROSS

Here the *female* F₁ of a black X vestigial mating are crossed with the double recessive *male*. The original linkages are broken by crossing over in the formation of 17 per cent of the eggs. Chromosome conventions as in Fig. 91.

that in approximately 17 per cent of reduction divisions in the female a crossing over occurs between the two parts of the chromosome on which the two mutant genes respectively occur.

This conclusion can be tested by the method already

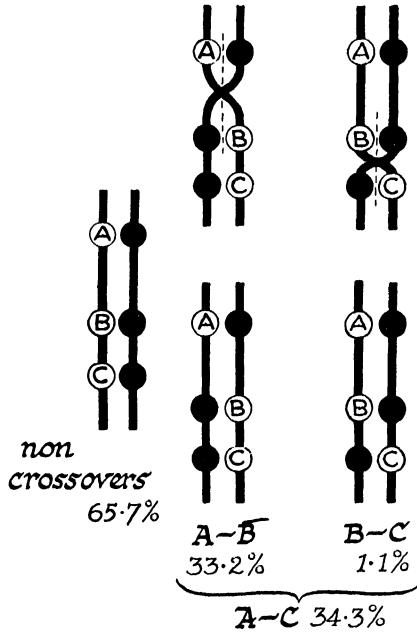

FIG. 93—LINEAR ARRANGEMENT OF THE GENES

applied to white eye, yellow body, and miniature wing mutants. The mutant with purple eyes is a simple recessive to the normal red-eyed condition. The mutant with the bent-up "curved wing" is a simple recessive to the normal long-winged condition. In a cross between individuals involving the vestigial and curved-wing characters the cross-over percentage was 8.2 based on a generation of 1,861 flies. The cross-over value for the purple and curved genes was

19.9 based on a generation of 61,361 flies. The expected cross-over between vestigial and purple genes would therefore be $19.9 \pm 8.2^* = 28.1$ or 11.7. In an actual experiment in which 15,210 flies were reared, the cross-over value between purple and vestigial proved to be 11.8. The cross-over value for black and purple is 6.2, based on a generation of 51,957 flies. The expected cross-over value for the black vestigial cross would therefore be $6.2 \pm 11.8 = 18$ or 5.6. In an actual experiment, based on 23,731 flies, the value 17.8 was obtained. To add yet another case in which the interrupted wing vein character, known as "plexus," was investigated, the cross-over value for the purple and plexus factors was 47.7, based on 350 flies. The expected value for plexus-black would thus be 47.7 ± 6.2 , i.e. 53.9 or 41.5. In an actual experiment, involving 2,460 flies, the cross-over percentage was found to be 41.9. So we can arrange another group of mutant genes in a definite order on one of the remaining three pairs of the chromosomes of the fruit fly. The locus of purple lies between the loci of black and vestigial about twelve units of length from the latter and six from the former.

Experiments up to date have shown that all the mutant genes of *Drosophila* fall into four groups (Fig. 94). Members of the same group tend to stick together—completely in the male, and with a definite amount of crossing over in the female. Members of different groups behave in a manner analogous to the ebony-vestigial cross, i.e. they show "free assortment" in segregation. Thus the number of *linkage* groups corresponds to the number of pairs of chromosomes,

* The sign \pm in this context means that the expected cross-over value exceeds (+) or falls short (-) of the preceding figure by the amount stated.

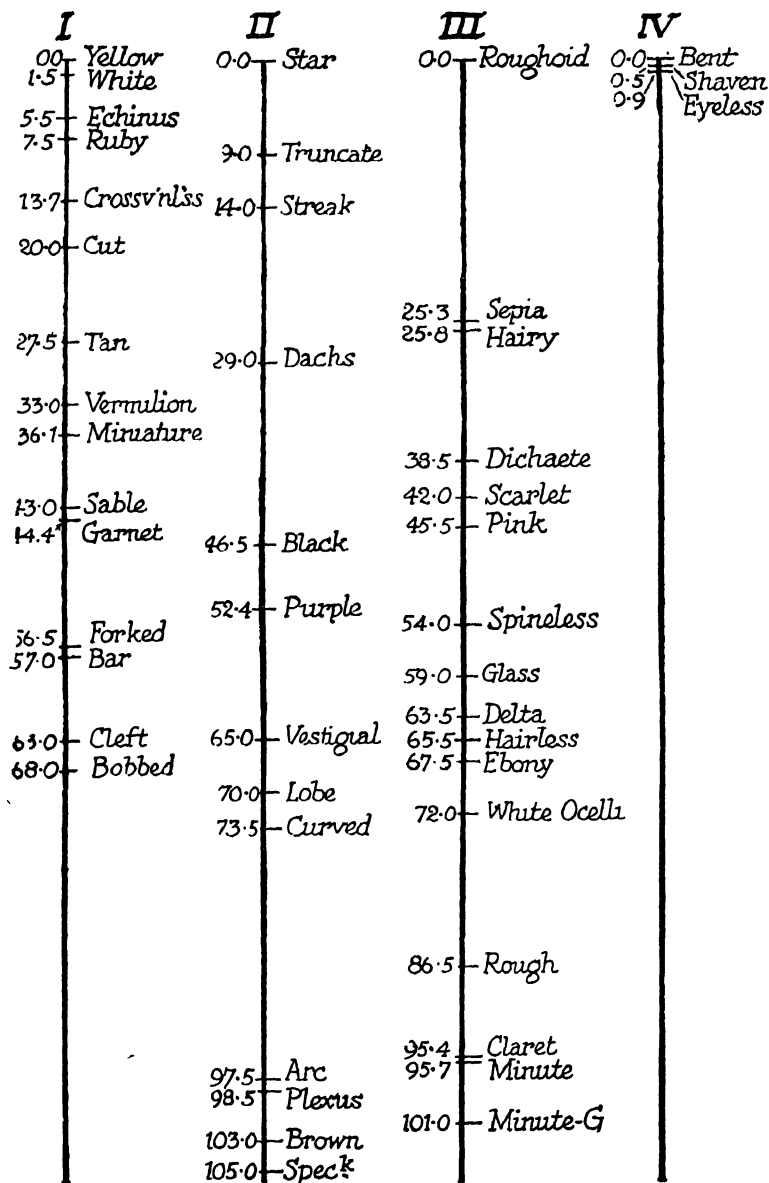

FIG. 94.—MAP OF SOME OF THE MUTANT GENES OF DROSOPHILA

and of these four groups one, the smallest, can be identified with the small "fourth" pair of chromosomes in *Drosophila* on account of abnormal genetical results obtained in crossing flies in which one member of this pair of chromosomes was found to be absent. Recently Punnett has shown the existence of seven linkage groups in the sweet pea which has seven pairs of chromosomes. So the arrangement of the genes in linear series has been shown to hold good for the sweet pea. We may conclude that the results obtained with experiments on the fruit fly are of general applicability.

The Universal Validity of the Principle of Segregation.— We have now to turn to the consideration of a question of some importance in connexion with the problems which we shall study in the second part of this book, namely whether the Principle of Segregation applies to all the heritable properties of the organism. When Mendel's principles were first rescued from obscurity, few, if any, biologists would have been so bold as to assert that they apply to all types of heredity, and the majority were only willing to concede grudgingly a restricted validity to the Law of Segregation. Many continued to speak as if there were two sorts of inheritance, Mendelian and non-Mendelian. Every year since the beginning of this century has witnessed a wider extension of the principle which Mendel first announced.

At one time a great deal of confusion arose through the use of the misleading term "unit *character*." A single clear-cut anatomical *difference* may involve one or many genes. There is no relation between the magnitude of the one and the extent of the other. The inheritance of the walnut type of comb in the domestic fowl illustrates a clear-cut character difference which involves two mutant genes. A character difference which involves two mutant genes on different

pairs of chromosomes leads to nine instead of four distinct types in the F.₂ generation, and the analysis of this result would not be at all obvious at first sight. If three dominant or recessive genes on different pairs of chromosomes determine a single character difference, the F.₂ individuals would fall into one class with all three dominant characters, three classes with two dominant characters, three classes with one dominant character, and one class with no dominant characters in the ratio 27 : 9 : 9 : 9 : 3 : 3 : 3 : 1. If neither member of any of the three pairs of characters show dominance the number of classes will be twenty-seven instead of eight.

So extremely complicated cases may arise, when only a few genes are involved in the inheritance of some discrete anatomical or physiological difference distinguishing two strains. If only four genes on different pairs of chromosomes come into play, and none is dominant to its alternative, the number of classes in the F.₂ is 81. Even so, we have only exhausted a small fraction of problems that present difficulty at first sight. The successful analysis of such difficult cases justifies the confidence which Mendel's principle now enjoys.

Numerical proportions which arise through crossing hybrids depend partly on dominance, partly on the number of genes involved, and partly on the "interaction" of genes. Two simple cases of the interaction of genes may be cited. On crossing a black and a red guinea pig, the F.₁ individuals are of the mouse grey type known to breeders as agouti. The F.₂ individuals are agoutis, blacks, and reds in the ratio 9 : 3 : 4. This at once suggests that the red strain carries a dominant gene which modifies black, but does not modify red, so that the F.₂ reds are composed of two classes, one which mated to black gives agouti and one which mated

to black gives black. An example which specially bears on the species problem is the case of two strains of sweet peas, both white and pure for white when inbred, but giving an F.₁ of coloured individuals and an F.₂ of 9 : 7 coloured to white when crossed. If strain A carries a gene absent in strain B, and strain B carries a gene absent in strain A, if both are located on different pairs of chromosomes, both having arisen in a coloured stock, both tending to make the colour white, and both recessive, the result necessarily follows from the fact that out of every sixteen three will have A in duplicate, three will have B in duplicate, and one will have both A and B in duplicate, making seven whites.

An entirely different type of complication arises when a gene affects the viability of the offspring. Such genes are classed together under the general term *lethals*. An immense number of cases of this kind have been thoroughly investigated with the most rigorous quantitative treatment. We need only take a single example, that of a sex-linked lethal in *Drosophila*. Some females of *Drosophila* have an excessive proportion of female offspring, in fact, a 2 : 1, instead of a 1 : 1 sex ratio. This is explicable on the assumption that such females bear on one of their sex chromosomes a gene which, if not compensated by a normal sex chromosome, prevents the individual from surviving to maturity. As the male has only one sex chromosome, every male which inherits a lethal-bearing X chromosome from its mother dies. The hypothesis is tested rigorously by mating such females to white-eyed males, when the disturbances in the ratios of white-eyed and red-eyed individuals conform to the assumption that one maternal chromosome carries something which prevents the survival of her male offspring arising from eggs possessing it.

The most difficult, and for long the most insoluble problem which arises in the study of inheritance was the transmission of characters which normally show a good deal of variability with reference to environment. In discussing hereditary properties in what has gone before we have assumed that the bodily expression of the gene has been clear-cut, and the environmental condition necessary to its appearance a normal concomitant of the conditions of life. When this is so, our problem is greatly simplified, and it is by the scrutiny of such simple cases that we gain knowledge which enables us to investigate the more intricate. To clarify this distinction, let us revert to the case of Mendel's experiments with tall and dwarf peas. The F₂ tall individuals are not all of the same size, nor are the dwarfs. Each has a certain range of variability with respect to the local conditions in which the individual seed germinates. Nevertheless, they are distinct groups. Given proper conditions, the smallest tall is recognizably larger than the largest dwarf. In dealing with size characteristics, however, hereditary differences may not be so nicely defined. Often they can only be described in statistical terms. Two inbred stocks may differ by some average that is characteristic of the progeny of individuals reared under identical conditions, but it may be quite impossible to distinguish the individuals themselves.

This makes ordinary experimental procedure impossible. But the problem is simplified if the organism is hermaphrodite and self-fertilizing, as are many plants. If we take beans from a mixed collection of the same species but not of the same parentage, and weigh them, we can arrange them in groups according as they fall within certain limits. On counting the number of beans in each group or class, we can plot a curve of which the ordinates represent the numbers

in a class (class frequency) and the abscissæ correspond to the mean value of each class. In general the curve will have the shape indicated in Fig. 95. If we select individual beans of different sizes, and allow them to germinate and seed by self-fertilization, we find, as was first shown by Johansen

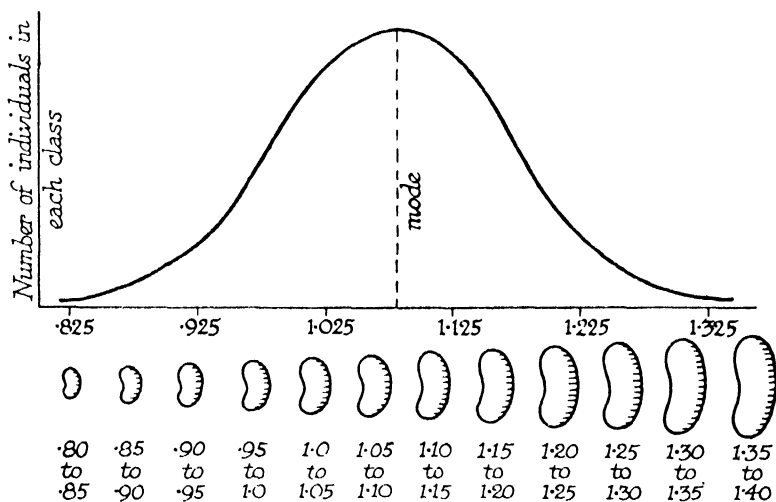

FIG. 95—NORMAL FREQUENCY CURVE ILLUSTRATED BY VARIABILITY IN WEIGHT OF BEANS

(1909), that the frequency curves for the progeny of some are well nigh identical in form with those of the original mixed population. Others, however, will have curves whose most fashionable value or *mode* corresponds to a higher or lower class than that of the mixed population. If we take any of the offspring of a bean whose progeny show a high or low modal value and allow it in turn to germinate and seed, we find that the modal class of its grandchildren will be the same as that of their parent. Thus we can have two stocks of beans distinguished only by the fact that they regu-

larly produce offspring whose frequency curves for the size character in question display a constant difference of the modal class value. When equal numbers of individuals from both stocks are mixed the two series might so completely overlap that the mixed population would yield a frequency curve with only one peak.

Let us now see how we might test whether the theory of the gene applies to heritable properties of this type. Unless sex-linked factors are involved in a cross between parents of two different pure-bred strains, all the individuals of the F.1 must be genetically alike. Any differences that exist among them *inter se* will be due to external agencies alone. The differences between individuals of the F.2 will always be the result, on the other hand, of both genetic differences and bodily variability, and there can never be more genetic types in any succeeding generation than appear in the F.2. Hence, if the Principle of Segregation applies to cases like height, weight, girth, growth-rate, etc., cases, that is, where the character in question is a very variable one, any cross between individuals of pure strains differing with respect to the modal value of the character must always conform to a simple rule: maximum variability in the F.2 and minimum variability in the F.1. The test is one which has been satisfactorily applied to many cases.

The mathematical treatment of this problem when one factor difference is concerned can be set forth without recourse to elaborate statistical treatment. Let us take the case of two parents of stocks whose progeny give the curves P.1 and P.2, which are supposed to be based on the same number of individuals, let us say 1,000. The two series overlap but their modes are different. For the sake of simplicity let the modal value for the F.1 curve be taken as

intermediate, and the F.1 curve in Fig. 96 be plotted for the same number of individuals as the P.1 and P.2. Now the F.2 generation will consist of three genetic types, the two parental types and the F.1 type, and for each individual of

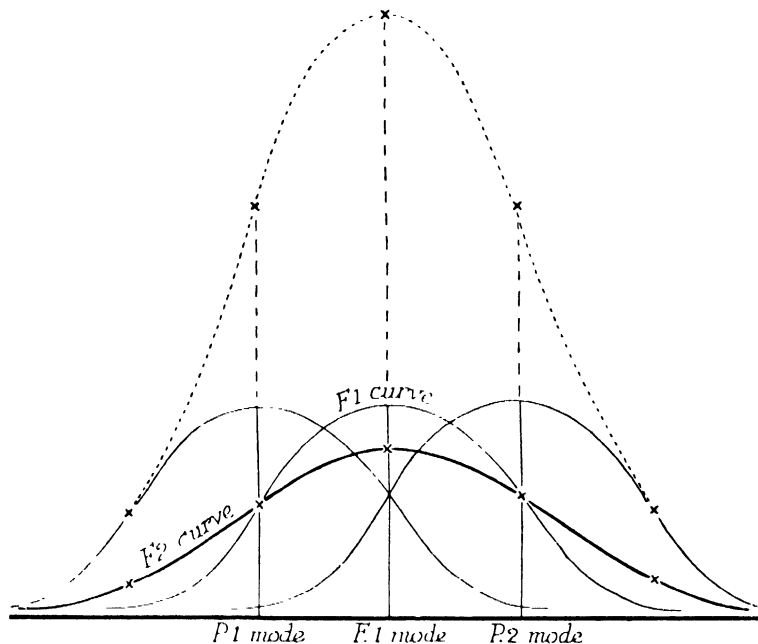

FIG. 96—CURVES TO ILLUSTRATE MAXIMUM VARIABILITY IN THE SECOND GENERATION (see text)

the parental types there will be two of the F.1 on the Principle of Segregation. Let us, therefore, add each ordinate of the parental curves to twice the value of the corresponding ordinates of the F.1. The new dotted curve will be based on 4,000 individuals. To reduce this to comparable dimensions with the P.1 and P.2 curves we must divide each ordinate by 4. This gives us the flat curve of the F.2. The flatness of this curve shows the greater variability of the

F.2, and affords a mathematical test of the validity of the Principle of Segregation as applied to highly variable characters. A few applications of this method of analysis to animals (number of tail feathers in pigeons, e.g.) have been made, and it has been extensively tested in plant breeding.

Application of Genetics to Human Ecology.—In the absence of definite knowledge about hereditary transmission the improvement of stock and seed-producing crops was accomplished by inbreeding and by artificial selection. Individuals with the selected characteristic were propagated by repeated mating of close relatives having the same characteristic. If this is carried on for many generations pure lines of homozygous individuals can be established. What could only be achieved by a long process of selection and inbreeding can now be brought about by systematic testing in two or three generations. The difference between the two methods can be illustrated by taking an example analogous to comb inheritance in poultry (p. 194 and Fig. 86).

In rabbits two varieties, Blue Bevan and Chocolate Havana, are distinguished by the slate and reddish brown colour of the fur. If pure individuals of both types are crossed, the hybrid is black. When the black hybrids are mated with one another four colour types of offspring are produced, namely black, blue, chocolate, and a fourth whose pale silvery coat is called "lilac." The fact that there are four types shows that we are dealing with two mutant genes. One recessive gene (b) makes black fur slate-blue, the other (c) makes black fur reddish brown, both together make black fur lilac. The F₁ hybrids receive b from their blue and c from their chocolate parents respectively. They have neither in duplicate. So if b and c are assumed to be recessive, the F₁ hybrids should be black. All the possible genetic types

which may occur may be represented in the letter symbols thus:

Black	BB	CC	BB	Cc
				Bb	CC	Bb	Cc
Blue	bb	CC	bb	Cc
Chocolate	BB	cc	Bb	cc
Lilac			bb	cc

Suppose now that black rabbits had been produced for the first time by crossing the Blue Bevrán and Chocolate Havana. The fancier or furrier of the old school would first mate the F₁ black hybrids *inter se*. About 9 out of every 16 of their offspring would be black and these would include all the four "genotypes" indicated above. There will therefore be 10 types of possible matings of black litter mates as indicated in the ensuing table.

	BB CC	BB Cc	Bb CC	Bb Cc
BB CC	(i)	(ii)	(iii)	(iv)
BB Cc	(v) = (ii)	(vi)	(vii)	(viii)
Bb CC	(ix) = (iii)	(x) = (vii)	(xi)	(xii)
Bb Cc	(xiii) = (iv)	(xiv) = (viii)	(xv) = (xii)	(xvi)

Of these ten types only one BB CC × BB CC will yield offspring which will infallibly breed true to type by continued interbreeding. If he relies on inbreeding to get a pure stock the breeder has to go on breeding black brother to black sister, rejecting parents which throw blue, chocolate, or lilac offspring, till one of the stocks has been observed to produce no throw-backs for several generations. After about twenty

generations this result will usually have been achieved. Selective inbreeding is an exceedingly wasteful way of getting it, because there is a simple way of deciding to which genotype an F₂ black hybrid belongs. By making a chess board diagram (see Fig. 82) you will see that when mated to lilac (bb cc),

BB CC gives progeny all black

BB Cc gives progeny 50 per cent black and 50 per cent chocolate

Bb CC gives progeny 50 per cent black and 50 per cent blue

Bb Cc gives progeny 25 per cent black, 25 per cent chocolate, 25 per cent blue, and 25 per cent lilac.

So if each F₂ hybrid black is mated once to a lilac individual the production of an all-black litter makes it almost certain that it is a pure black (BB CC). The odds are at least 127 to 1 in a single litter of seven and 4,095 to 1 if two successive all black litters of seven are reared. At one step we can therefore determine which of the F₂ hybrids are pure stock, and so achieve the result required in the second generation from the original cross.

You will also see that there is no need to inbreed twenty generations of lilac rabbits to get a pure stock. All lilac rabbits must be pure, since they are double recessives. If we had started, knowing only the black and lilac colour varieties, we should, of course, get the same result in the F₁ and F₂ of a cross between lilac and pure black. Some of our blue and chocolates would be impure. If we wanted to build up pure stocks of either, we could test the blues and chocolates for further use by mating to lilac, when

BB cc would give all chocolate

Bb cc would give 50 per cent chocolate and 50 per cent lilac

bb CC would give all blue

bb Cc would give 50 per cent blue and 50 per cent lilac.

This is an exceedingly simple example of the practical application of genetic principles. The fact that thirteen genes which affect the growth of the pollen tube are now known to be involved in the phenomenon of self-sterility in cherries will help you to get a picture of the scope of modern genetical research. Just as he can combine the genes of varieties with pea and rose comb to produce a pure walnut and single comb stock of poultry, or the genes for blue and chocolate to get a pure stock of black and lilac rabbits, the modern geneticist can combine the genes responsible for high resistance to a parasite (e.g. virus or rust) and for high yield of fruit, or for high yield and high baking quality of grain.

EXAMPLES ON CHAPTER VII

1. A purple-eyed mutant of *Drosophila* crossed to pure wild stock which has red eyes, always gives offspring all red-eyed. In one experiment the hybrids were mated *inter se* and gave offspring 107 red-eyed and 38 purple-eyed. Interpret this with the aid of a diagram. How would you test the genetic constitution of the red-eyed animals?

2. A fruit fly with vestigial wings and ebony body colour is crossed to wild type. The F₁ flies are back crossed to the double recessive (ebony-vestigial) and the result is:

wild type 32
 ebony (normal wing) 29
 vestigial (grey body colour) 30
 ebony vestigial 31

Interpret this result with the aid of a diagram. What would be the result of mating the wild type in the last experiment *inter se*?

3. All the F₁ generation of a cross between a fowl with single and a fowl with walnut comb (pure bred) have walnut combs. Back crosses of walnut to single gives the following:

walnut comb 73
 rose comb 71
 pea comb 74
 single comb 75

Interpret this result by means of a diagram. What would be the result of mating those with walnut combs *inter se*?

4. The white plumage of leghorn poultry is dominant to coloured, feathered shanks is dominant to clean, and pea comb is dominant to single. What would be the result of back crossing the F.₁ of a pure white, feathered, bird with a pea comb and a black, clean, bird with a single comb to the triple recessive?

5. A race of black rabbits mated to lilac gives black hybrids which, when mated to their lilac parents, yield black, blue, chocolate, and lilac offspring in approximately equal numbers. Four black offspring of black *hybrid* parents behaved as follows. Buck A crossed with a lilac female had one surviving offspring which was lilac. When crossed with Doe B, the same buck sired three successive litters, including in all 13 black and 3 blue offspring. With Doe C it also sired three litters including in all 6 chocolate and 13 black offspring. With Doe D it sired only black offspring in four successive matings. Interpret these data, giving the genetic constitution of the four individuals.

6. A yellow male mutant of *Drosophila* crossed to wild type (grey) females always gives grey offspring. A yellow female mutant crossed to pure-bred wild type male has offspring half of which are grey females and half yellow males. Interpret this result with the aid of a diagram. What will result if flies from each of the F.₁ are mated *inter se*?

7. Barred plumage is a sex-linked character of the Plymouth Rock breed dominant to the black of the Ancona breed. A black Ancona hen is crossed with a Plymouth Rock cock and the F.₁ males are crossed back to the mother, the F.₁ females being crossed back to the father. What are the results obtained? What would be the result of an analogous experiment in which the reciprocal cross was the starting point in the parental generation.

8. White eye is a sex-linked recessive in *Drosophila*. White-eyed males are crossed to wild type females and the F.₁ flies are mated *inter se*. What is the result in the F.₂? How would you test the constitution of each of F.₂ females without the use of white-eyed males?

9. Interpret the following experiment on *Drosophila* hybrids with the aid of a chromosome diagram:

Pure stock sable male by pure stock wild type female gave only wild type offspring. These hybrids when mated *inter se* gave offspring as follows:

wild type males 146	sable males 155
wild type females 305	sable females 0

What results would you expect in the reciprocal cross?

10. Interpret the following experiments with the aid of a diagram: A pure wild stock of male *Drosophila* was crossed to the mutant white-eyed stock, and its progeny when mated *inter se* yielded a generation composed of:

white-eyed females 76	white-eyed males 73
wild type females 69	wild type males 68

With another white-eyed female the same type of experiment was carried out and the second generation was composed of:

white-eyed females 97	white-eyed males 46
wild type females 91	wild type males 93

11. Construct a diagrammatic solution of the following problem:

In *Drosophila* vermilion eyes are referred to a sex-linked recessive mutant from the red-eyed wild stock. Certain vermilion-eyed females have vermilion-eyed male and female and red-eyed male and female offspring when crossed to wild type. These females have a Y chromosome in addition to the normal XX group. How would you test their offspring in a cross with red-eyed males to detect differences in genetic constitution of outwardly similar individuals?

12. Yellow (body colour), vermilion (eye colour) and sable (body colour) are sex-linked mutants of *Drosophila*. A yellow-vermilion male is crossed to a wild type female, and the female offspring crossed to a wild type male. The result is:

wild type females 120
yellow vermilion males 38
wild type males 42
yellow males 21
vermilion males 23

A vermilion male is crossed to a sable female and the female offspring crossed to wild type males. The result is:

wild type females 144
vermilion males 64
sable males 62
vermilion sable males 8
wild type males 6

What would be the result of crossing the female offspring of a sable-yellow female and a wild type male to wild type males?

13. Two dark-bodied strains of *Drosophila* were homozygous for vestigial (i.e. both strains were vestigial). When crossed together these strains gave vestigial wing and grey body (wild type). Each of these strains was then crossed to wild type and the F₁ males back-crossed to their own double recessive parent. The results were as follows:

Strain A.

dark body 23
 vestigial 21
 dark body vestigial 20
 wild type 25

Strain B.

dark body 0
 vestigial 0
 wild type 75
 dark body vestigial 81

Interpret these results with the aid of a diagram.

14. A laboratory worker forgot to label new culture bottles of dark-body and vestigial used in the previous examples. In order to rectify this, males from each were crossed to wild type females and the F₁ males were then crossed back to respective double recessives. The temperature regulation of the incubator went out of order, and the temperature rose to a very high level, killing the parent flies. One yielded 12 W.T. and 10 others all double recessive. The second yielded two flies only, both of which were dark-bodied with normal wings.

Use this information to identify your unlabelled cultures, giving reasons. Supposing these flies had been dark-bodied with vestigial wings could he have labelled his bottles? Give reasons.

15. Illustrate the principle of the linear alignment of the genes by means of the following experiments on *Drosophila* mutants.
 (a) Female offspring of vestigial by black back-crossed to the double recessive male gave:

vestigial 416	wild type 87
black 421	black vestigial 91

(b) Female offspring of vestigial-purple back-crossed to the double recessive male gave:

vestigial 336	wild type 44
purple 325	purple vestigial 42

(c) Female offspring of black-purple back-crossed to the double mutant male offspring gave:

black 464	wild type 28
purple 488	black purple 32

16. In a cross between the yellow-bodied mutant and a male of the vermilion-eyed mutant stock of *Drosophila*, the F₂ generation produced by mating the hybrids *inter se* was as follows:

yellow females 103	wild type males 36
wild type females 98	vermilion-eyed yellow-bodied males 33
vermilion males 66	
yellow males 64	

Explain this result with a diagram, and determine the probable percentage of the following types:

wild type male and female;
 vermilion, yellow male and female;
 vermilion male and female;

in the F₂ generation of the cross between a wild type female and a vermilion-eyed yellow-bodied male.

17. A black purple vestigial female was crossed to a wild type male, and the F₁ females were crossed back to black purple vestigial males. The following results were obtained:

black purple vestigial 105	
wild type 104	
black 6	
purple vestigial 8	
black purple 15	
vestigial 17	
black vestigial 1	} (double crossover)
purple 1	

Interpret this by means of a diagram. Note the small number of double cross-overs.

18. In a series of linkage crossovers of the X chromosome yellow was found to be 36 units (% crossover between yellow and minia-

ture) from miniature, white was found to be 36 units from miniature and yellow was found to be 1 unit from white. The numbers on which this was based were small. The experiment as it stands yields no information as to the order of yellow, white, and miniature. Female offspring of yellow males and white miniature females were crossed to wild type males. The following was the result:

wild type females 105
 white miniature males 37
 yellow males 34
 wild type males 1
 yellow white miniature males 1
 yellow miniature males 20
 white males 19
 white yellow males 0
 miniature males 0

What is the order of genes concerned? What conclusions could you draw if there had been no yellow white miniature, no wild type, no miniature, and two yellow whites?

19. A purple vestigial strain in *Drosophila* was crossed to wild type, and the offspring were found to be all wild type. The F₁ females were mated singly with single purple vestigial males and two cultures gave the following result:

<i>Culture I</i>	<i>Culture II</i>
purple vestigial 80	purple vestigial 57
wild type 82	wild type 104
purple 11	purple 11
vestigial 9	vestigial 25

Interpret these results with the aid of a diagram, and state what experiments you would set up to prove your hypothesis. You may assume that animals suitable for mating were retained in both cultures.

PART II
HOW ANIMALS DIFFER

CHAPTER IX

THE DIVERSITY OF ANIMAL LIFE

BROADLY speaking, we can study animals from two points of view. We may concentrate our attention on the living machine as a going concern, and investigate the relation of its parts to one another and the relation of its processes to the properties of non-living systems. We may also be interested in the differences between different kinds of animals, and investigate how these differences have arisen. So far we have been chiefly concerned with the first. We shall now devote ourselves to the second.

Though no two animals of the same sex are exactly alike, it is a matter of common observation that some are much more alike than others, and that individuals which are very much alike inter-breed and preserve their common characteristics. Barriers to inter-breeding may be natural or artificial. Assemblages of individuals which preserve common characteristics which distinguish them from other animals by breeding among their own kind are called *species*, when nature supplies the barriers. When they are segregated by human interference they are called *breeds*, *strains*, *races*, *domestic varieties*, or *pure lines*. From what we have learned in the previous chapter we know that pure lines or domestic varieties exist because of the occasional occurrence of mutations; and because of the combination of mutant characters which breed true to type by hybridization and by subsequent selection of homozygous individuals.

A laboratory or a flower garden is a part of nature. So if mutations can occur in a laboratory or in a flower garden, they

presumably occur when there are no human beings in their vicinity. On the whole those that live longer or produce more offspring will survive. As species spread over a larger area natural conditions in different regions will favour the survival of some mutant combinations rather than of others. In the course of time what was once a single species will have broken up into several, which will do the same again. Intermediate types will die out. The differences among the progeny of ancestors which were once recognized as a single species will become more sharply defined, and the gaps will obscure their common family resemblance. Thus climate and the changing contours of the earth's surface during prolonged periods of time continually impose on living organisms a process comparable to the selection of new domestic strains.

Though it has been accepted generally by scientific workers for less than three-quarters of a century, the doctrine of evolution, which is the belief that species change in this way and that the immense variety of living animals have a common ancestry, is not essentially new. It was foreshadowed in the writings of the Greek materialists. Before its credentials could be established, obstacles due to ignorance about the elementary facts of birth and parenthood, the grades of structural similarity among different types of animals, the history of past life on earth and the present distribution of living creatures in different parts of the world had to be got out of the way by laborious observations of countless investigators. That all animals reproduce sexually, that animals can be arranged in groups which exhibit greater or less degrees of family likeness, that animals which are totally unlike any living ones existed on earth millions of years before Man, and that different geographical regions have their own characteristic faunas, are facts known to

almost any literate adult in the Western world of to-day. Three hundred years ago nobody knew them; and it was possible for educated people to accept beliefs which now appear to be fantastic. According to the painstaking Biblical researches of Archbishop Ussher who wrote at the end of the seventeenth century, the solar system did not exist on September 27, 4004 B.C., and the human male was created by the Trinity on October 4th of the same momentous year at eight o'clock in the morning.

The Principle of Biogenesis.—In the brief statement of evolution given on the preceding page we have taken for granted the fact that *like begets like* in accordance with the universal characteristics of sexual reproduction explained in the first chapter of this book. This is quite a modern belief, tentatively put forward by Harvey three hundred years ago. Before the introduction of simple microscopes at the beginning of the seventeenth century people had no knowledge about how any small animals or about how the majority of marine ones produce offspring. The prevailing view was that of Aristotle, whose authority has probably been responsible for more delusions and superstitions than that of any single member of the human species with the possible exception of Plato. Aristotle took the dramatic view of sex, that is to say, that animals reproduce sexually if they copulate or associate in pairs. Other animals were at liberty to reproduce according to the fancy or prejudice of those who wrote about them. Here is a representative specimen of Aristotle's *Natural History*:

Some of them are produced from similar animals, as phalangia and spiders from phalangia and spiders. . . . Others do not originate in animals of the same species, but their production is spontaneous, for some of them spring from the dew which falls from plants. . . .

Some originate in rotten mud and dung. . . . Butterflies are produced from caterpillars and these originate in the leaves of green plants, especially the raphanus which some persons call crambe. . . . The gnats originate in ascarides (thread-worms) and the ascarides originate in the mud of wells and running waters that flow over an earthy bottom. At first the decaying mud acquires a white colour, which afterwards becomes black, and finally red. . . .

Such transformations were still the subject of current belief at the time of the Renaissance. The following passage from Gerard's *Herball* (1594) is representative of its time:

But what our eyes have seene; and the hands have touched we shall declare. There is a small Island in Lancashire called the Pile of Foulders, wherein are found the broken pieces of old and bruised ships, some whereof have beene cast thither by shipwracke, and also the trunks and bodies with the branches of old and rotten trees, cast up there likewise, whereon is found a certain spume or froth that in time breedith unto certain shells, in shape like those of the Muskle, but sharper pointed, and of whitish colour, wherein is contained a thing in forme like lace of silke finely woven as it were together, of a whitish colour, one end whereof is fastened unto the inside of the shell, even as the fish of Oisters and Muskels are: the other end is made fast unto the belly of a rude masse or lumpe, which in time commeth to the shape of a Bird; when it is perfectly formed the shell gapeth open, and the first thing that appeareth is the foresaid lace or string; next come the legs of the bird hanging out, and as it groweth greater it openeth the shell by degrees, til at length it is all come forth, and hangeth onely by the bill: in short space after it cometh to full maturitic and falleth into the sea, where it gathereth feathers, and groweth to a fowle bigger than a Mallard and less than a goose having blacke legs and bill or beak, and feathers blacke and white, spotted in such manner as is our magpie. . . . For the truth hereof if any doubt, may it please them to repaire unto me, and I shall satisfie them by the testimonie of good witnesses. . . . The bordes and rotten planks whereon are found these shels breeding the Barnakle are taken up on a small Island adjoyning Lancashire, halfe a mile from the main land, called the Pile of Foulders. They spawn as it were in March and April; the Geese are formed in May and June, and come to fulnesse of feathers in the month after. And thus having through God's assistance discoursed

somewhat at large of Grasses, Herbs, Shrubs, trees and Mosses, and certain Excrescences of the earth, with other things moe, incident to the historie thereof, we conclude and end our present Volume, with this Wonder of England. For the which God's Name be ever honoured and praised.

According to the Aristotelean view which lingered on till the beginning of the eighteenth century, there was no *one* process of natural generation such as we take for granted when we discuss the common ancestry of animals to-day.



FIG. 97—FIGURE OF THE BARNACLE AND GOOSE IN GERARD'S *Herball* (1594)

Hence the first step towards the modern theory of evolution was the recognition of *biogenesis*, i.e. the rule that *like begets like*. The discovery of spermatozoa with the first microscopes at the end of the seventeenth century brought about a complete revolution in the history of man's knowledge of the universe. A practical result of this was the recognition of sexuality in plants, and hence the production of new hybrid varieties by artificial pollination. The successes of commercial horticulturalists and seed merchants stimulated stock-breeders to new efforts, which resulted in great improvements of cattle and sheep.

Micro-organisms.—The invention of the microscope also

revealed a world of organisms quite unlike any previously known. Stelluti (1630), who was one of the earliest microscopists, refers to them in the following words:

I have used the microscope to examine bees and all their parts. I have also figured separately all members thus discovered by me to my no less joy than marvel, since they are unknown to Aristotle and to every other naturalist.

Some organisms of microscopic dimensions are recognizably like animals of visible size with bodies built up of cells. A few, such as the *Rotifera* or wheel animalculæ of fresh waters are not like any familiar animals in other ways. Many micro-organisms included in what we now call the *Protista* do not correspond to what we should ordinarily describe by the terms animal or plant. *Paramœcium*, which is one of them, has been mentioned already in Chapter I.

Paramœcium.—How *Paramœcium* propagates its kind has been described already but nothing has been said about the way it feeds or about its behaviour. On the under side of the cigar-shaped body, which is about one-third of a millimetre long and therefore just visible to the eye, there is a groove covered with cilia in perpetual motion like the cilia which cover the rest of the surface. This groove (Fig. 99) leads into a funnel directed backwards towards the pointed end of the body. The funnel terminates in a small area called the *mouth*, where the outermost and more resistant layer of the body is incomplete. Solid particles of organic debris or smaller micro-organisms are washed backwards to the mouth and are engulfed in a film of water by the viscous interior. These solid particles with their surrounding film of water are called *food vacuoles*. Food vacuoles circulate around the body, and are more or less completely absorbed.

Eventually any *non-assimilable* matter is ejected from a temporary opening at a fixed spot behind the mouth on the undermost surface.

Paramœcium also exhibits a process which may be called excretion. Its chemical nature is not understood. So it is not certain that it is at all comparable to the *nitrogenous* excretory function of our own kidneys. In the viscous interior near the extremities of the upper surface there are two pulsating reservoirs of clear fluid called *contractile vacuoles*. The contractile vacuoles are connected with radiating canals of clear fluid in the surrounding substance or *endoplasm*. The radiating canals and the central vacuole pulsate alternately, and the latter seems to discharge the fluid accumulated therein through the peripheral pellicle of more resistant *ectoplasm*.

Paramœcium is constantly on the move, swimming by the lashing motion of its cilia with its blunt end foremost. The cilia do not move simultaneously. A wave of motion progresses along the axis of the body, as in the motion of cilia on the gill of the mussel. The appearance is like stalks of wheat when a breeze sweeps over a field. In response to certain changes in its surroundings Paramœcium may abandon this indiscriminate and continuous locomotion. The principal types of response which it shows may be called *browsing* and *avoidance* reactions.

The browsing reaction is a feeding response. The favourite food of Paramœcium is bacteria which are apt to stick together in clumps. When it comes up against such a clump, it becomes still. All the cilia cease to beat except those inside the food groove. The cilia around the mouth create a vigorous food current which sucks in bacteria. When the meal is finished it gets on the move. The effective stimulus is

contact. Paramœcium will browse without effect, if it comes up against a piece of cotton.

The avoidance reaction takes place when Paramœcium swims into strong light, collides with a surface, or gets into the neighbourhood of a hot object or a harmful chemical reagent. Its first reaction is to stop dead. It then turns sharply through an angle of indefinite dimensions and goes off again in a straight line. It will repeat this several times, if necessary, till its line of motion takes it out of danger, i.e. out of the field of the effective stimulus.

Inside the body of Paramœcium there are two permanent objects which take up nuclear stains. The smaller or *micronucleus* divides by mitosis during reproduction and is comparable to the nucleus of animal or plant cells. Sometimes two Paramœcia come together side by side. When this process of *conjugation* occurs each *micronucleus* divides three times. The process involves reduction of the chromosomes to half the normal number. Six of the eight products degenerate. Of the two persisting one remains behind and the other migrates. In each conjugant the migratory nucleus fuses with the one which stays at home. The two Paramœcia then separate, each with a new micronucleus of which only half the chromosome content originally belonged to. This process of conjugation reproduces two essential features of *Sexuality*, i.e. nuclear reduction and restitution of the diploid number of chromosomes by nuclear fusion. It is not correct to call it sexual *reproduction*, because it does not of itself lead to the production of a new individual, and is equally comparable to the reciprocal copulation of two earthworms.

Amœba.—The term *Protista* proposed by Haeckel (1834–1919) includes a various assemblage of minute forms of

living matter, such as the bacteria. Some of the Protista have been customarily grouped together, on account of their active locomotion and absence of assimilatory pigments, as *Protozoa* or primitive animals. Such are for instance *Paramœcium* and the ciliary parasites like *Opalina* and *Balantidium* which abound in the rectum of the frog. Some Protozoa secrete shells of siliceous or calcareous material. They are respec-

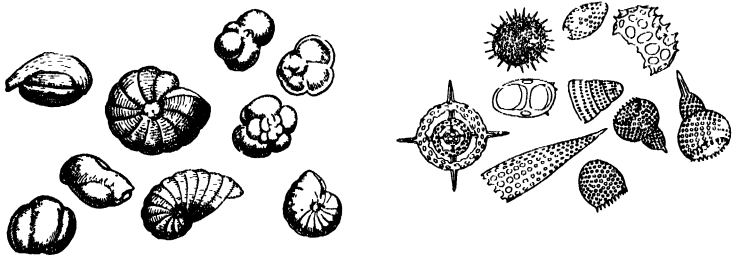

FIG. 98—SHELLS OF RADIOLARIA AND FORAMINIFERA

Some Protista which live freely in water surround themselves by siliceous (the Radiolaria) or calcareous (the Foraminifera) shells of microscopic dimensions, or just large enough to be visible to the eye. The Chalk has mainly been formed by deposits of Foraminifera, whose dead shells accumulated on the sea bottom.

tively denoted by the terms Radiolaria and Foraminifera. Both of these have left abundant fossil remains, and the Foraminifera are largely responsible for the laying down of the chalk strata. A common object of the microfauna of muddy water, the *Amœba*, first described by Rosenel of Nurnberg in 1755, is closely related to Protozoa with shells.

Freshwater *Amœbæ* can usually be found in the muddy bottoms of ditches and ponds. They may attain a size just visible to the naked eye. Under the microscope they appear as masses of translucent granular material, the shape of which is constantly changing. The body substance or *protoplast* is constantly flowing out in processes called *pseudo-*

podia. As new pseudopodia are formed old ones are withdrawn, and by this streaming out of the cell substance Amœba both creeps over the surface to which it is attached and engulfs the food which it is constantly taking in. This food consists of smaller organisms and organic debris. What is called the *contractile* vacuole of Amœba is not a fixture like those of Paramœcium. It is a clear spherical fluid vesicle, which enlarges and bursts, discharging its contents to the exterior. So soon as it has burst another begins to form.

There are several reasons for keeping a separate niche for microorganisms such as Paramœcium, Amœba or Euglena. One is that the body of what we ordinarily call an animal is divided up into cells, and these cells are not all alike. They form different systems of tissues and organs performing different work. So when we speak of reproduction we mean the net result of a process of *repeated* cell division. Where no such differentiation exists the clear outlines of the division between animals and plants breaks down. Before there was a separate assemblage for organisms which are not divided into cells, botanists and zoologists competed for the privilege of classifying many of them as primitive plants or primitive animals. The same creature was classified as a flagellate by a zoologist and as an alga by a botanist. Another would be catalogued among animals under the heading Mycetozoa in one text-book and as a fungus under the heading Myxomycetes in another.

Amœba reproduces like Paramœcium by binary fission. This process involves the division of a structure within the body substance which stains like the nucleus of the cells of animal bodies, and behaves in division like a nucleus. In short, Amœba is essentially like one of the colourless cells in the blood of the frog or Man. The white blood corpuscle is

however, part of a whole animal, whereas *Amœba* is a complete independent organism. Many writers speak of the Protozoa as unicellular organisms on this account. As

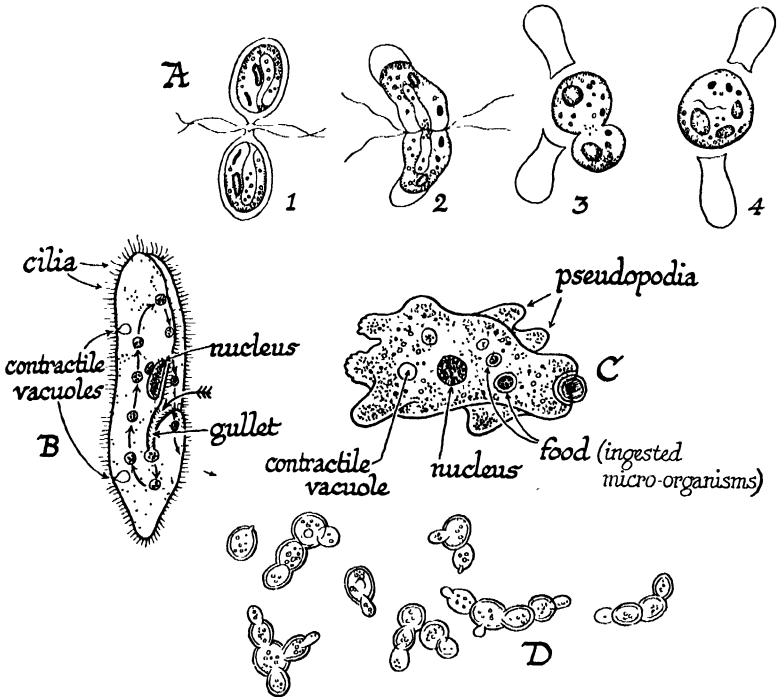

FIG. 99—TYPES OF MICRO-ORGANISMS

- (A) A green form, called *Chlamydomonas*, which progresses by the aid of two long cilia called flagella: four stages in the conjugation of similar gametes.
- (B) *Paramecium*. Food particles in clear droplets are seen travelling round the body from the "gullet" to the place where fæces are discharged at a temporary opening in the surface. The "contractile vacuoles" get rid of surplus water which has entered the organism by osmosis.
- (C) *Amœba*, which progresses by a flowing motion in which temporary lobes of the body are pushed out. This specimen is in the act of enclosing another Protist to form a food vacuole in which digestion will take place.
- (D) Yeast. Successive stages of budding are seen, leading to the formation of chains of cells.

Dobell has pointed out, it is more consistent to refer to them as non-cellular, since the term cell was first given to the parts of a whole plant or animal.

Euglena.—Many motile Protista do not move by pseudopodia like *Amœba* and are not uniformly covered with fine cilia like *Paramœcium*. They have a tuft of one or more very long cilia (*flagella*) at one or both ends of a more or less spindle-shaped or pea-shaped body. A large proportion of these flagellate types have *chlorophyll* and can build up sugar from carbon dioxide and water in sunlight. They move about as animals do and feed like green plants.

A representative type common in stagnant water is *Euglena viridis*, a pear-shaped micro-organism generally about a third as long as *Paramœcium*. It has a single long cilium attached to the blunt end near the short gullet and mouth. There is an excretory vacuole in the neighbourhood of the latter. The rest of the interior of the body is largely taken up with the nucleus and the *chloroplasts*—rod-like tracts of protoplasm containing *chlorophyll*. The only known method of reproduction is fission.

Euglena can take solid food like an animal or manufacture carbohydrate in sunlight like a plant. It can also stretch itself like an animal because its body is not bounded by a cellulose wall like that of a plant cell. Another green flagellate called *Chlamydomonas* has more definite plant characteristics. The ellipsoidal body is only slightly pointed at one end, where its *two* flagella are attached and its two contractile vacuoles are located. It has no gullet and cannot take solid food. It cannot stretch itself, because the whole body is enclosed in a cellulose capsule.

Reproduction occurs by repeated fusion inside the cellulose capsule. Normally four individuals are produced.

Each secretes a coat of cellulose and develops a pair of flagella. They then escape from the ruptured parental capsule. Sometimes more numerous (8-64) individuals are formed. These small ones then proceed to associate in pairs by contact at the end where the cilia come off. The details of conjugation vary among species assigned to the family in which *Chlamydomonas* is placed. The cilia are shed, and the cellulose capsule breaks down at the point of fusion. The naked bodies of the conjugants may fuse before or after escaping from the common ruptured capsule. In some species the conjugants are of equal size. In others smaller conjugants derived by more repeated divisions of a single individual always unite with larger ones. The process of fusion is *complete*, and is followed by the secretion of a thick cellulose capsule. No cilia are produced. After a short rest four ciliated individuals are produced inside it by the ordinary process of internal fusion.

This is not strictly comparable to the *exchange* of nuclei by conjugation in *Paramœcium*, and is more like the fusion of true gametes in ordinary animals and plants. Gametes produced by flagellates and by certain parasitic Protozoa show every gradation between complete equality (*isogamy*) at one extreme and differentiation of the type characteristic of sexual production in animals or flowerless plants. Thus in some species the larger of the two conjugants has no flagellum and is *non-motile* like an egg.

Naturally a clear appreciation of their structure did not emerge until after the Cell Theory of Schleiden and Schwann (1834-9) had been established. The comparison between the body of a Protist and a cell of the body of a typical animal or plant was first made by Barry (1843) and von Siebold (1845). Up till that time Protista had been classified under

the term Infusoria (now retained for the ciliate Protozoa only) along with a number of minute organisms, among which may be mentioned the Rotifera, or wheel animalculæ, which abound in fresh water. The Rotifers, first seen by Leeuwenhoek (1677), who also described numerous Protozoa, are, in spite of their small size, animals of fairly complex organization, with tissues and organs formed of separate cells. Till the advent of the Cell doctrine there were numerous biologists who attributed to the Protozoa an elaboration of internal organs analogous to those of a typical animal.

Controversy concerning the propagation of the Protista continued from their discovery by Leeuwenhoek until nearly the end of the nineteenth century. In 1718 Joblot showed that hay infusions can be sterilized by boiling against infection with Infusoria. From 1765 onwards, in a series of researches, Spallanzani continued this work, improving the technique of Joblot by boiling his cultures in hermetically sealed flasks, so that the surrounding air was sterilized. On the basis of his experiments Spallanzani asserted the doctrine of Biogenesis as applicable to the micro-organisms. But the study of minuter forms of life—the *bacteria*—after the improvements of microscopic apparatus in the first half of the nineteenth century reopened the question. For while better microscopic equipment permitted more detailed study of the life histories of the Protozoa and thus firmly established the principle that like begets like for the Infusoria, it led to the recognition of smaller organisms which are far more resistant to heat.

Pasteur's name has pre-eminence in connection with the identification of the bacteria as the agents of putrefactive processes, and it was his work which first placed on a firm basis the universal truth of the doctrine of Biogenesis. The

reality of spontaneous generation was reaffirmed by a French zoologist Pouchet, in 1858, in a paper communicated to the Académie des Sciences under the title "Note on Vegetable and Animal proto-organisms spontaneously generated in artificial air and oxygen gas." In a series of researches published in the three succeeding years Pasteur took up the challenge. Pasteur began with the microscopic study of atmospheric air. He passed air continuously through plugs of cotton wool, and showed that by adding the deposited dust to sterile media, cultures of bacteria could be obtained. He then showed that the most putrescible fluids remained uninfected if kept out of range of atmospheric dusts. After Pasteur's work the question was again reopened by Bastian during the seventies. Bastian in particular dwelt upon the fact that mere boiling for short periods does not suffice to destroy all bacterial organisms, but the later investigations of Tyndall and of Dallinger and Drysdale led to the recognition of stages in the life cycle of bacteria that are more resistant to heat than is the motile form. Since that time the issue has not been raised. The possibility that ultra-microscopic organisms are spontaneously generated is not absolutely disproved, but there is no reason to believe in it.

The Principle of Unity of Type.—When the common features of reproduction had been elucidated, there were still many obstacles to be overcome before it was plausible to speculate with profit about the diversity of animal types in nature. Any citizen of a large city in America or Europe can now visit public museums and zoological gardens, where he can get a world view of animal life. It is a commonplace that cats, tigers, leopards, and lions, or that dogs, wolves, and jackals have a family likeness, and it is also a common-

place that cats and dogs resemble each other more than they resemble rabbits and guinea pigs. Hence it is not difficult for anybody nowadays to grasp the possibility of arranging the animal kingdom in grades of family resemblance. Indeed it is hard to understand that any civilized people could have failed to recognize it. The perspective of the mediterranean world of Aristotle was quite different. Very few people had any knowledge of animals other than those which inhabit a limited geographical region. The physicians of antiquity pigeon-holed plants with alleged medicinal properties, but there was no social impetus for systematic classification of animal life in ancient times, and even if there had been the means of transport available it would have led to a very limited view of the ways in which animals resemble or differ from one another. Four hundred years ago the faunas of America were still unknown. Two hundred years ago little was known about the faunas of tropical Asia, and nothing was known about the faunas of tropical Africa or of the Australian region. Systematic classification of animals, and with it correct beliefs about the degrees of family likeness which animals display, has been the result of expanding communications and more rapid transport during the last century.

The first attempt to make a complete survey of available information concerning animal life is included in the *Systema Naturæ* of Linnæus. This was published in the middle of the eighteenth century. From the practice of contemporary botanists Linnæus adopted the convention of arranging animals in different grades of resemblance. Species are grouped in genera, genera in families, families in order, families in classes. Each species has a christian name and a surname. The surname is the name of the genus in which it is placed and is put first. Families of genera which resemble

one another most closely, like the Patrician families of Rome, take the suffix *-idæ*. Thus human beings of whatever nationality, "race," or creed are representatives of the species *Homo sapiens*, of the family *Hominidæ*, of the genus *Homo*. In modern classifications of animals the Hominidæ include various fossil types such as *Pithecanthropus*, the Ape-man of Java, and are placed with monkeys in the order Primates of the class *Mammalia*. To-day it is customary to assemble classes in larger groups called phyla. Mammals are placed with birds and fishes in the phylum Vertebrata.

The system of Linnæus divided the animal kingdom into six classes, Mammalia, Aves, Amphibia, Pisces, Insecta, and Vermes. The first, second, and fourth correspond closely with the modern groups of the same name. In addition to the Amphibia of present-day zoologists, the Amphibia of Linnæus includes reptiles and several fishes such as the sturgeon and shark. Linnæus' class "Insecta" corresponds to the phylum which we call the Arthropoda. Linnæus divided his Insecta into seven orders, in one of which, the "Aptera," he placed along with true wingless insects, in the modern usage of the term, all other Arthropods, namely, Crustacea, Arachnida, and Myriapoda (see p. 273). The names of the remaining orders of Linnæus' "Insecta" are retained in classifications of insects still in use (Coleoptera—beetles; Lepidoptera—butterflies; Diptera—houseflies and gnats; Hymenoptera—bees, ants, etc.). In the sixth class, Vermes, Linnæus placed all animals other than Vertebrates and Arthropods.

The classification of Linnæus (from *Syst. Nat.*, 12th ed., 1766) including a complete list of genera was as follows:*

* The student will find no difficulty in identifying the names from museum specimens.

Class I. MAMMALIA

Order 1. *Primates*

Genera: *Homo*, *Simia*, *Lenur*, *Vespertilio*.

Order 2. *Bruta*

Genera: *Elephas*, *Trichecus*, *Bradypus*, *Myrmecophaga*, *Manis*, *Dasybus*.

Order 3. *Feræ*

Genera: *Phoca*, *Canis*, *Felis*, *Viverra*, *Mustela*, *Ursus*, *Didelphys*, *Talpa*, *Sorex*, *Erinaceus*.

Order 4. *Glires*

Genera: *Hystrix*, *Lepus*, *Castor*, *Mus*, *Sciurus*, *Noctilio*.

Order 5. *Pecora*

Genera: *Camelus*, *Moschus*, *Cervus*, *Capra*, *Ovis*, *Bos*.

Order 6. *Belluæ*

Genera: *Equus*, *Hippopotamus*, *Sus*, *Rhinoceros*.

Order 7. *Cete*

Genera: *Monodon*, *Balæna*, *Physeter*, *Delphinus*.

Class II. AVES

Order 1. *Accipitres*

Genera: *Vultur*, *Falco*, *Strix*, *Lanius*.

Order 2. *Picæ*

Genera: (a) *Trochilus*, *Certhia*, *Upupa*, *Buphaga*, *Sitta*, *Oriolus*, *Coracias*, *Gracula*, *Corvus*, *Paradisea*; (b) *Ramphastos*, *Trogon*, *Psittacus*, *Crotophaga*, *Picus*, *Yunx*, *Cuculus*, *Bucco*; (c) *Buceros*, *Alcedo*, *Merops*, *Todos*.

Order 3. *Anseres*

Genera: (a) *Anas*, *Mergus*, *Phæthon*, *Plotus*; (b) *Rhyncops*, *Diomedea*, *Alca*, *Procellaria*, *Pelecanus*, *Larus*, *Sterna*, *Colymbus*.

Order 4. *Grallæ*

Genera: (a) *Phænicopterus*, *Platalea*, *Palamedea*, *Mycteria*, *Tantalus*, *Ardea*, *Recurvirostra*, *Scolopax*, *Tringa*, *Fulica*, *Parra*, *Rallus*, *Psophia*, *Cancroma*; (b) *Hematopus*, *Charadrius*, *Otis*, *Struthio*.

Order 5. *Gallinæ*

Genera: *Didus*, *Pavo*, *Meleagris*, *Crax*, *Phasianus*,
Tetrao, *Numida*.

Order 6. *Passeres*

Genera: (a) *Loxia*, *Fringilla*, *Emberiza*; (b) *Caprimulgus*, *Hirundo*, *Pipra*; (c) *Turdus*, *Ampelis*,
Tanagra, *Muscicapa*; (d) *Parus*, *Motacilla*,
Alauda, *Sturnus*, *Columba*.

Class III. AMPHIBIA

Order 1. *Reptilia*

Genera: *Testudo*, *Draco*, *Lacerta*, *Rana*.

Order 2. *Serpentes*

Genera: *Crotalus*, *Boa*, *Coluber*, *Anguis*, *Amphisbæna*, *Cæcilia*.

Order 3. *Nantes*

Genera: *Petromyzon*, *Raja*, *Squalus*, *Chimæra*,
Lophius, *Accipenser*, *Cyclopterus*, *Balistes*, *Ostracion*,
Tetrodon, *Diodon*, *Centriscus*, *Syngnathus*,
Pegasus.

Class IV. PISCES

Order 1. *Apodes*

Genera: *Muræna*, *Gymnotus*, *Trichurus*, *Anarrhichas*,
Ammodytes, *Ophidium*, *Stromateus*, *Xiphias*.

Order 2. *Jugulares*

Genera: *Callionymus*, *Uranoscopus*, *Trachinus*,
Gadus, *Blennius*.

Order 3. *Thoracici*

Genera: *Cepola*, *Echeneis*, *Coryphæna*, *Gobius*,
Cottus, *Scorpæna*, *Zeus*, *Pleuronectes*, *Chaetodon*,
Sparus, *Labrus*, *Sciæna*, *Perca*, *Gasterosteus*,
Scomber, *Mullus*, *Trigla*.

Order 4. *Abdominales*

Genera: *Cobitis*, *Amia*, *Silurus*, *Zeuthis*, *Loricaria*,
Salmo, *Fistularia*, *Esox*, *Elops*, *Argentina*,
Atherina, *Mugil*, *Mormyrus*, *Exocætus*, *Polynemus*,
Clupea, *Cyprinus*.

Class V. INSECTA

Order 1. *Coleoptera*

Genera: (a) *Scarabæus*, *Lucanus*, *Dermestes*, *Hister*, *Byrrhus*, *Gyrinus*, *Attelabus*, *Curculio*, *Silpha*, *Coccinella*; (b) *Bruchus*, *Cassida*, *Plinus*, *Chrysomela*, *Hispa*, *Melæ*, *Tenebrio*, *Lampyrus*, *Mordella*, *Staphylinus*; (c) *Cerambyx*, *Leptura*, *Cantharis*, *Elater*, *Cicindela*, *Buprestis*, *Dytiscus*, *Carabus*, *Necydalis*, *Forficula*.

Order 2. *Hemiptera*

Genera: *Blatta*, *Mantis*, *Gryllus*, *Fulgora*, *Cicada*, *Notonecta*, *Nepa*, *Cimex*, *Aphis*, *Chermes*, *Coccus*, *Thrips*.

Order 3. *Lepidoptera*

Genera: *Papilio*, *Sphinx*, *Phalæna*.

Order 4. *Neuroptera*

Genera: *Libellula*, *Ephemera*, *Myrmeleon*, *Phryganea*, *Hemerobius*, *Panorpa*, *Raphidia*.

Order 5. *Hymenoptera*

Genera: *Cynips*, *Tenthredo*, *Sirex*, *Ichneumon*, *Sphex*, *Chrysis*, *Vespa*, *Apis*, *Formica*, *Mutilla*.

Order 6. *Diptera*

Genera: *Æstrus*, *Tipula*, *Musca*, *Tabanus*, *Culex*, *Empis*, *Corops*, *Asilus*, *Bombylius*, *Hippobosca*.

Order 7. *Aptera*

Genera: (a) Pedibus sex; capite a thorace discreta: *Lepisma*, *Podura*, *Termes*, *Pediculus*, *Pulex*.
 (b) Pedibus 8-14; capite thoraceque unitis: *Acarus*, *Phalangium*, *Aranea*, *Scorpio*, *Cancer*, *Monoculus*, *Oniscus*.
 (c) Pedibus pluribus; capite a thorace discreto: *Scolopendra*, *Julus*.

Class VI. VERMES

Order 1. *Intestina*

Genera: (a) Pertusa laterali poro: *Lumbricus*, *Sipunculus*, *Fasciola*.
 (b) Imperforata poro laterali nullo: *Gordius*, *Ascaris*, *Hirudo*, *Myxine*.

Order 2. *Mollusca*

- Genera: (a) Ore supero; basi se affigens: *Actinia*, *Ascidia*.
 (b) Ore antico; corpore pertuso laterali foraminulo: *Limax*, *Aplysia*, *Doris*, *Tethis*.
 (c) Ore antico; corpore tentaculis antice cincto: *Holothuria*, *Terebella*.
 (d) Ore antico; corpore brachiato: *Triton*, *Sepia*, *Clio*, *Lernæa*, *Scyllæa*.
 (e) Ore antico; corpore pedato: *Aphrodita*, *Nereis*.
 (f) Ore infero centrali: *Medusa*, *Asterias*, *Echinus*.

Order 3. *Testacea*

- Genera: (a) Multivalvia: *Chiton*, *Lepas*, *Pholas*.
 (b) Bivalvia (= *Conchæ*): *Mya*, *Solen*, *Tellina*, *Cardium*, *Mactra*, *Donax*, *Venus*, *Spondylus*, *Chama*, *Arca*, *Ostrea*, *Anomia*, *Mytilus*, *Pinna*.
 (c) Univalvia spira regulari (= *Cochleæ*): *Argonauta*, *Nautilus*, *Conus*, *Cyprææ*, *Bulla*, *Voluta*, *Buccinum*, *Strombus*, *Murex*, *Trochus*, *Turbo*, *Helix*, *Nerita*, *Haliotis*.
 (d) Univalvia absque spira regulari: *Patella*, *Dentalium*, *Serpula*, *Teredo*, *Sabella*.

Order 4. *Lithophyta*

- Genera: *Tubipora*, *Madrepora*, *Millepora*, *Cellepora*.

Order 5. *Zoophyta*

- Genera: (a) Fixata: *Isis*, *Gorgonia*, *Alcyonium*, *Spongia*, *Flustra*, *Tubularia*, *Corallina*, *Sertularia*, *Vorticella*.
 (b) Locomotiva: *Hydra*, *Pennatula*, *Tænia*, *Volvox*, *Furia*, *Chaos*.

The characters of the six classes are thus given by Linnæus:

Cor biloculare, biauratum;	sanguine calido, rubro:
viviparis,	<i>Mammalibus</i>
oviparis,	<i>Avibus</i>

Cor uniloculare, uniauratum; sanguine frigido, rubro:
 pulmone arbitrario, *Amphibiis*
 branchiis externis, *Piscibus*

Cor uniloculare, inauratum; sanguine frigida, albida:
 antennatis, *Insectis*
 tentaculatis *Vermibus*

There are no positive common characteristics which unite the species placed by Linnæus in the class Amphibia other than those which all Vertebrates share. There are no common characteristics of the Vermes other than those which all animals which are neither Vertebrates or Arthropods share. There is no common family resemblance of the species put in the order Aptaera other than those which all Arthropods share with all the other orders in the fifth class of this system. There is nothing to indicate the family likeness common to the four classes which we now call Vertebrates.

In an age when the Biblical account of the Creation was generally accepted in Europe and America, common similarities, such as those embodied in the system of Linnæus, were ascribed to creative design for the requirements of particular habitats. Accordingly we find that the orders of winged insects and the class Aves are groups of which the constituent species generally pursue similar habits of life. The *Systema Naturæ* has one outstanding exception to correspondence between architecture and habitat. Though they have a fish-like shape and a fish-like habit, whales (*Cete*, or as we now say, *Cetacea*), are clearly animals whose general organization is like that of other mammals. As the study of comparative Anatomy progressed during the next century naturalists began to see that most groups united by a common architecture include some species whose mode of life is very different from that of the majority.

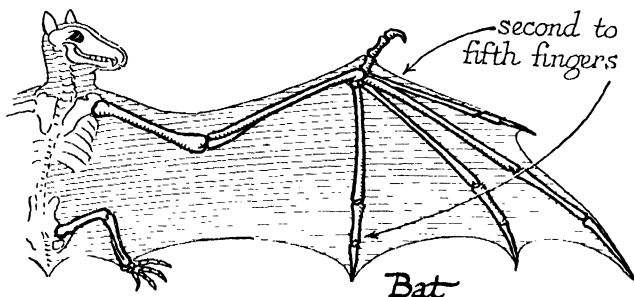
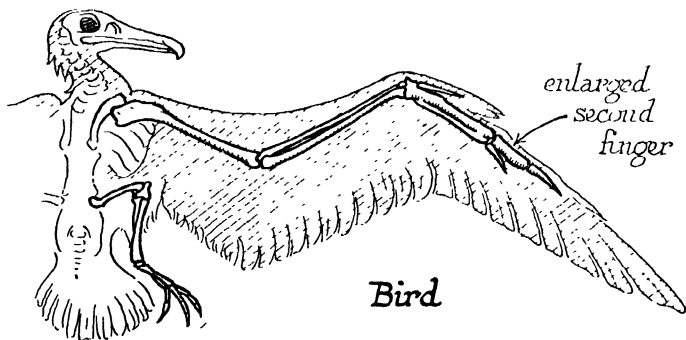
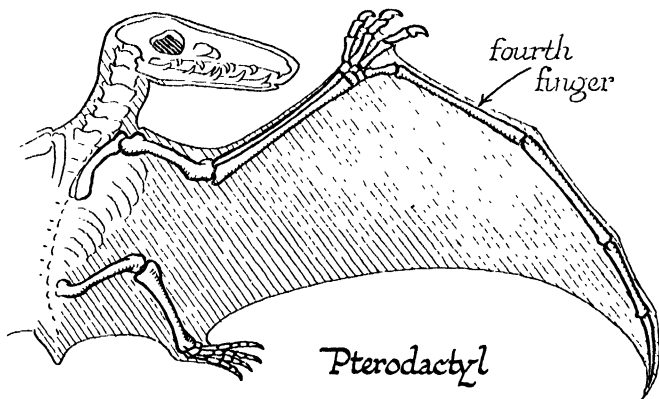

FIG. 100—VERTEBRATE WINGS

The extinct flying reptiles called Pterodactyls had a wing membrane stretched between the elongated fourth finger and the hind limb. In bats, the second to fifth fingers are long and the hind limb again helps to keep the membrane taut. Birds have feathers, which stand out stiffly on their own account, and the awkward tying up of the hind limbs with the organs of flight is thus avoided.

Another fact became clear. Though most members of many groups may share many features which distinguish them sharply from species included in others, some species occupy an intermediate position and bridge what would otherwise be wide gaps in the scheme of classification. An impressive example of this turned up when the world became acquainted with the fauna of Australia after Captain Cook's voyages. Two mammals, the Duckbill (*Platypus*)

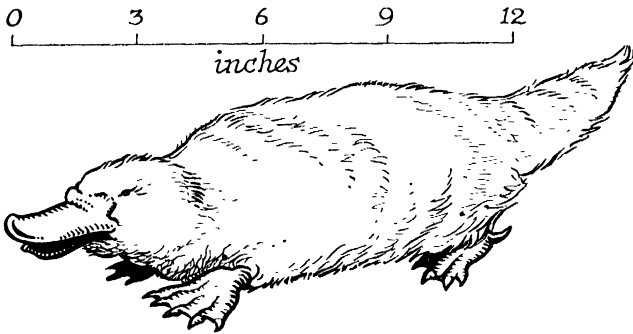

FIG. 101—THE DUCK-BILLED PLATYPUS

and the Spiny Anteater (*Echidna*) of the Australasian region lay eggs with shells like those of the birds and reptiles, and have many reptilian characteristics which no other mammals possess. Their habits are quite different, and there is nothing about their situation or the kind of life they lead to suggest that their reptilian characteristics were designed by Providence for the rigours of life in Australia. The study of such intermediate types drew attention to the fact that the animal body has vestiges of organs which, if useful at any time, have now ceased to be so. The recognition of *Unity of Type* among species which do not live the same kind of life destroyed the complacent belief that all structural differences are

the expression of creative prescience, and thus encouraged naturalists to speculate about how such differences might be produced by natural agencies.

The Principle of Succession.—The belief that different species have come into being by natural agencies presupposes that the age of the habitable earth is immensely great in comparison with the record of human history. Till the middle of the nineteenth century the Biblical account of the age of the earth was still widely accepted in countries where biological studies were advancing. Towards the end of the eighteenth century Hutton put forward the view that the stratified rocks have been laid down by the continual wearing away of the earth's surface and the deposition of sediment on the ocean bed. The progress of geology encouraged the study of fossils about which little was known before the beginning of the nineteenth century. A third obstacle to the recognition of evolution was removed when modern views about the age of the earth were tested and finally accepted. The study of geology displayed vast vistas of time with an orderly succession of organic types, and showed that the earliest members of a group are more generalized than their modern descendants.

The Principle of Geographical Distribution.—While this belief gained ground the use of new communications and encouragement given to exploration made it possible to see the relation between structure and habitat from a new perspective. In the course of their travels naturalists began to notice that similarities associated with habitat are not exclusively associated with differences of climate or soil. They are also associated with barriers to dispersal. Areas that have been separated for long periods of time by high ranges or deep oceans are more likely to have species peculiar to them.

In other words, the differences between species are connected with the time during which they have been separated from one another.

In the next four chapters we shall examine the Principle of Unity of Type, the fossil record, and the phenomena of geographical distribution in greater detail.

TOPICS FOR HOME STUDY

1. What is meant by The Principle of Biogenesis?
2. Compare the structure, behaviour and reproduction of Protists with the higher animals.
3. In what respects does the system of Linnæus (*a*) recognise (*b*) neglect the principle of Unity of Type.

CHAPTER X

THE PRINCIPLE OF UNITY OF TYPE

THE Principle of Unity of Type, which impressed itself on students of comparative anatomy during the latter half of the eighteenth and the first half of the nineteenth century, has been defined in general terms on p. 259. Our first impressions of the diversity of animal life suggest that species fall into clearly defined groups, such as insects, fishes, birds, or sea urchins, which share a common pattern of organization and a common habit of life. As we pursue our studies further we find that we can assemble them in larger units which possess common characteristics of bodily structure, and do not necessarily share the same mode of existence. We also discover species which bridge the gap between the compact classes into which most animals can be put; and so force us to notice a pattern common to classes of animals which live in different situations, get their food from different sources, and move in different ways.*

Comparison of Vertebrate and Arthropod.—To illustrate structural uniformities which are associated with difference of habit and habitat three types of Vertebrates and three representatives of the Arthropod phylum will serve our purpose. In these two groups the greatest activity and complexity of behaviour is attained. The types we shall select are respectively characterized by an aerial, an aquatic, and a

* The subject matter treated in this chapter is intended to be supplemented by laboratory dissections of Invertebrates, as directed in a practical manual, and by field work and museum study with the use of some standard works such as those of Parker and Haswell, Shipley and MacBride or Sedgwick for further reference.

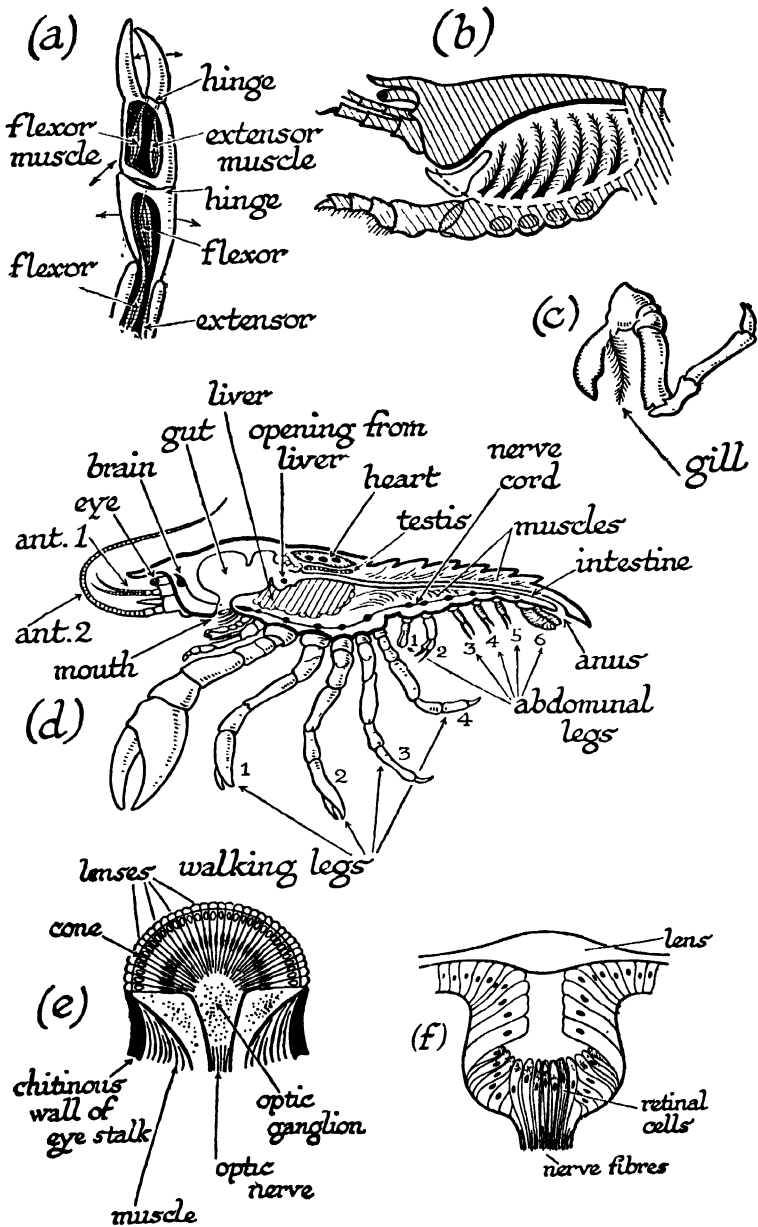

[Caption to fig. 102 at foot of page 273]

terrestrial method of existence. From the phylum Vertebrata it will be convenient to select the pigeon (*Columba livia*) as an aerial type, the dogfish (*Scyllium canicula*) as an aquatic type, and the frog or the rabbit (*Lepus cuniculus*) as a terrestrial type. As an aerial Arthropod, an insect, the cockroach (*Blatta orientalis*, the "black beetle," or *Periplaneta americana*, the large cockroach of bakehouses) is suitable because of its size and general availability, although immature individuals and the females of *B. orientalis* are wingless. As an aquatic Arthropod we shall take one of the larger crustaceans, such as the crayfish (*Astacus fluviatilis*) or the lobster (*Homarus vulgaris*). As a terrestrial flightless Arthropod we may select an Arachnid, the scorpion, because of its size. The species shown in Fig. 103 is the South African *Uroplectes insignis*, but any of the true scorpions, of which preserved specimens are easily obtainable for dissection, will serve.

Let us start with the characteristic responses of these two sets of types. The most obvious form of response is muscular activity. If we compare the wing of the pigeon, the pectoral fin of the dogfish, and the fore leg of the frog or rabbit, we notice that the innermost core of the limb of all these animals is a hard, jointed structure made of bone or cartilage. To these jointed skeletal elements the muscles are attached. The muscles are superficial to the joints; and the limb is not externally divided into clearly marked-off segments.

FIG. 102—ANATOMY OF THE CRAYFISH, ETC.

(a) Part of a walking leg with windows cut in the joints to show the muscles. Note the directions (indicated by arrows) in which each joint is able to move. (b) The gill chamber opened from the side. (c) Walking leg with gill attached. (d) Right half of a crayfish. In the heart, three of the openings which connect the heart with blood spaces can be seen. (e) Longitudinal section through the compound eye. (f) Longitudinal section through a simple Arthropodan eye.

The same remarks apply to the hind limbs of all three types and to the tail of the dogfish, which is its chief organ of propulsion. The relation of the muscles to the hard parts in our three Arthropod types is quite different. If we examine the walking legs of the cockroach, the crayfish, or the scorpion, we find that a limb of each is externally hard and is divided into very distinct segments. On cutting through the hard tubular wall of a limb, we find the muscles within the tube attached at one end to inward projections of one segment and to the internal wall of another segment at the opposite extremity (Fig. 102). The wing of the cockroach is attached at its base to muscles which pass in an analogous manner to the inner ventral surface of the hard wall of the thorax.

The trunk, like the limbs, of the three Arthropod types we are considering, is also segmented, and powerful extensor and flexor muscles attached to the hard outer shell of the body control its movements in a manner analogous to the action of muscles in the jointed limbs. In addition to the walking legs, the latter include other "appendages" used for various activities. The crayfish has nineteen pairs of appendages, thirteen being attached to the anterior unsegmented part of the body—the cephalothorax—and six to the six segments of the abdomen. The two most anterior pairs are feelers or *antennæ*. Then follow a series just behind the mouth, and these are employed for seizing and masticating the food. The most anterior pair, the *mandibles*, have powerful cutting bases. Behind these, but still on the cephalothorax, come five pairs of walking legs, of which the foremost end in the conspicuous pincers. The abdominal appendages are mostly two-branched or *biramous*, and are used in swimming or serve for the attachment and aeration of the eggs in

the female. But the first two pairs of abdominal appendages are exceptional. In the male they are employed for transferring seminal fluid to the female, while in the latter they

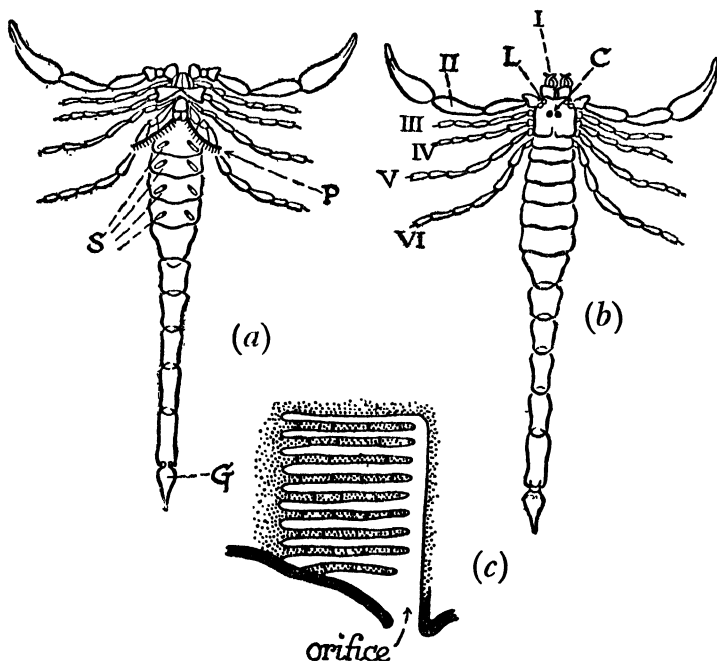

FIG. 103—THE CAPE SCORPION (*Uroplectes insignis*)

(a) Ventral view.

(b) Dorsal view.

(c) Microscopic section through book lung.

I-VI—Appendages. L—Lateral eyes (3 pairs). C—Compound eyes. P—Comb-like abdominal appendages or *pectines*. S—Openings of book lungs. G—Sting.

are small or absent. In addition to three pairs of walking legs, the cockroach has a single pair of *antennæ* or feelers and three pairs of masticatory appendages, one of which, the mandibles, have cutting bases (Fig. 104). The abdominal segments do not carry limbs, but some wingless insects, such as

the minute white *Campodea* found in soft soil under logs or stone, have small inconspicuous appendages—probably

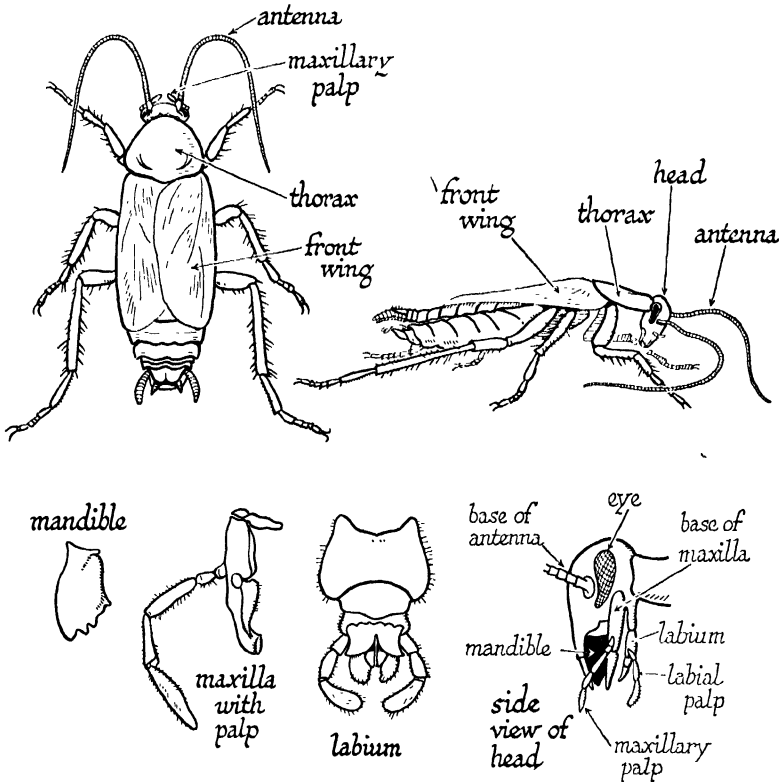

FIG. 104—THE ANATOMY OF THE COCKROACH

Above, two views of the whole animal, about $1\frac{1}{2}$ times natural size. The front wings are thickened and protect the thin hind wings which lie folded beneath them. Below, left, the mouth parts. Only one mandible and one maxilla of each pair is shown. The labium is a pair of appendages which have fused in the middle line.

quite useless—attached to the abdominal segments. The scorpion, like the spider and the tick, is a blood sucker. It has neither feelers nor masticatory mandibles like those of

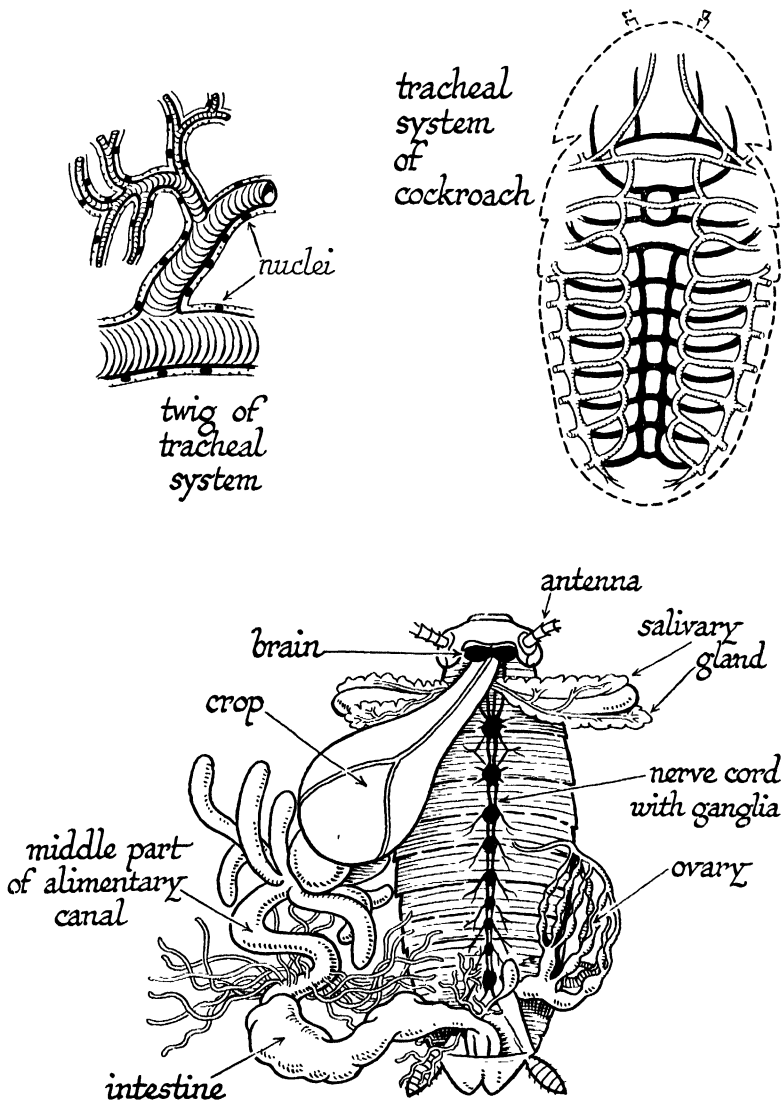

FIG. 105—THE ANATOMY OF THE COCKROACH—*continued*

the cockroach or crayfish. There are two pairs of appendages in front of the walking legs, the large pincers or *pedipalps*, used to seize the prey. In front of the mouth there is a three-jointed pair, the *chelicerae*, by which the animal attaches itself to the part from which it sucks the juices of its victim. In contradistinction to the crayfish, which has five, and the insect, which has three, the scorpion has four pairs of walking legs. Behind the last is a pair of comb-like appendages (*pectines*) whose precise significance, if any, is not known.

Bodily movement in the insect is notoriously influenced by light, and it is the light receptor which usually shows the greatest structural complexity of any of the receptor organs. To each of our Vertebrate types, the description of the eye with its cornea, iris, lens, aqueous and vitreous humour, retina (p. 64), is equally applicable. In all three the eye is movable within its orbit by the action of six very characteristic eye muscles. In all three the retinal part of the eye arises in the embryo as an outgrowth from the brain. The scorpion has two sets of eyes. There are three pairs of small eyes on either side at the anterior extremity, called the lateral eyes, and there is a single larger pair on the centre of the carapace. The lateral (*simple*) eyes consist of a biconvex thickening of the transparent cuticle lying over a group of photosensitive cells (cf. Fig. 102 *f*) which are the specialized endings of afferent fibres running back to the brain. In the central eyes these photosensitive cells are arranged in groups of about six around a central vitreous rod secreted by them, and are separated from adjacent groups by a thin layer of pigmented connective tissue cells. This subdivision of the retinal part of the eye into separate "retinulae" is carried still further in the large *compound eyes* (Fig 102 *e*) of the crayfish or of the cockroach, in which the surface of the

cuticle is divided into a number of separate facets. Between each facet and its underlying group of retinal cells there is an additional refractive "vitreous cone" secreted by a special group of cells which surround it.

There is no sharp line of demarcation between the extremely simple lateral eyes of the scorpion and the compound

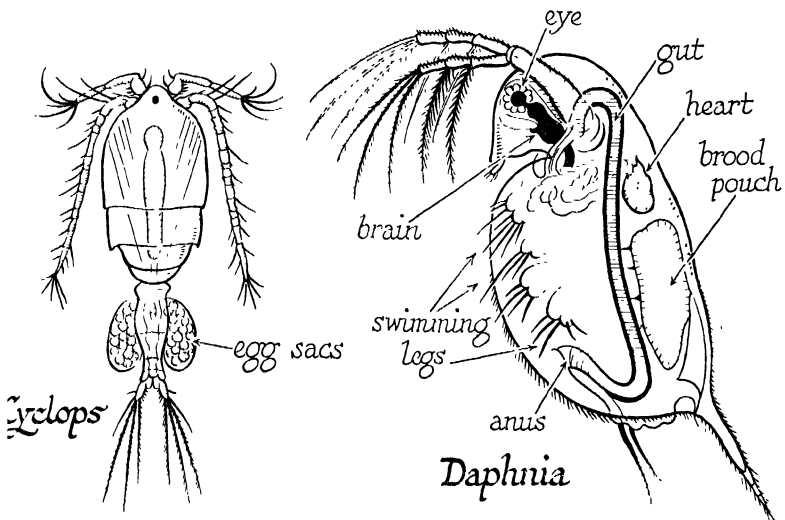

FIG. 106--TWO WATER FLEAS, MEMBERS OF THE CLASS CRUSTACEA, BOTH MAGNIFIED ABOUT 45 TIMES

eyes (Fig. 102) possessed by most of the phylum Arthropoda in which the scorpion, the cockroach, and the crayfish are placed. On the front of the head of some insects there are small eyes which are of the same type as the lateral eyes of the scorpion. Moreover, although many adult insects (such as the cockroach) do not possess these accessory simple eyes, the eyes of insect larvæ are of the simple type. Some Vertebrates have a structure of somewhat the same type as the simple eyes of some Arthropods. It is called the *pineal*

eye, and is best developed in the New Zealand lizard and in the lamprey larva. In all Vertebrates there is a median glandular body, the pineal gland, attached by a stalk to the posterior part of the dorsal surface of the fore brain. It is known to control the colour change of lampreys. In some reptiles it lies outside a small window in the top of the skull immediately beneath the epidermis, and such foramina are common in the skull of fossil reptiles and amphibia. In a few forms, such as those mentioned above, it has a structure very much like the eye of many invertebrates. From the embryological standpoint the paired eyes of Vertebrates differ from any Arthropod eye, in that the retina is developed as a cup-like outgrowth of the brain, which meets the cellular lens formed from the outer skin. The retinal elements of the Arthropod eye grow inwards in development to join the brain.

Let us next consider the linking up of the receptor and the effector, that is to say the apparatus of reflex response. In all the animals we are dealing with this involves the transmission of a nervous impulse through at *least* two fibres, one conveying it to a part of the concentrated mass of nervous tissue called the central nervous system, and one passing out from the C.N.S. by way of a nerve fibre whose cell body is present in the C.N.S. itself. The central nervous system of all our types is itself clearly demarcated into regions where the nerve cells are congregated, and regions composed exclusively of fibres running from one segment to another. In all there is a special concentration of nervous tissue at the anterior extremity of the body, where the mouth and eyes are located. Here the similarity ends. In the three Vertebrate types we have taken, the afferent fibre has its cell body (except in the case of the olfactory and optic nerves) in a

ganglion close to the junction of the nerve with the C.N.S. In the three Arthropod types the afferent nerve has its cell

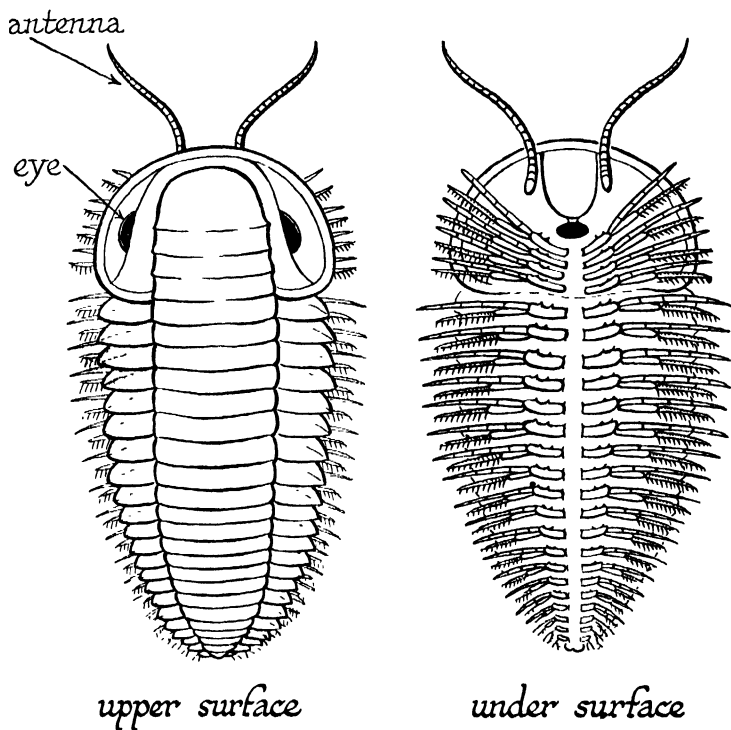

FIG. 107—TRILOBITE

The earliest representatives of the phylum Arthropoda found in the oldest sedimentary rocks are the Trilobites, a group which partake of the characteristics of all the more specialized classes which evolved later. Thus they have a single pair of feelers like insects, bifid swimming limbs like crustacea, and no specialized mandibles or biting jaws such as are present in insects and crustacea but absent in the arachnids.

body on the receptive surface. In the vertebrate types most of the large nerves are connected with the C.N.S. by *separate* afferent and efferent roots. In the Arthropod types this is not so. In the Vertebrate types the C.N.S. arises as a tubular

infolding of the outer skin of the embryo along the mid-dorsal line (Fig. 63), and is wholly dorsal to the alimentary canal. In the three Arthropod types the central nervous system (Fig. 108) lies above the alimentary canal at the anterior extremity only (brain or supracæsophageal ganglia). This part is connected by fine strands with a double cord composed of alternate thick portions (ganglia) and thin portions below the alimentary canal. In this type of C.N.S. the regions in which nerve cells and fibres occur alternate with one another, and a ganglion, or more strictly a pair of ganglia, is typically present in each distinct segment. In the Vertebrate C.N.S. the connecting fibres lie outside (white matter) the regions where nerve cells (grey matter) occur in the spinal cord.

If we now turn to those structures which are specially concerned with the distribution of the materials from which the energy of reflex response is derived, we see equally striking differences between the three Vertebrate and the three Arthropod types. In all the Vertebrate types we find three very characteristic sets of digestive glands manufacturing the same type of secretions—the gastric glands, the liver with its gall bladder, and the pancreas. No such close similarity is shown by the digestive system of the three Arthropod types, but we may note in all of them a feature which distinguishes them sharply from the Vertebrate types. For some length inwards both the hind gut and the fore gut are lined by a thin coat of *chitin*, the material of which the hard outer wall of the body is formed. The Vertebrates have in their blood a red, iron-containing pigment, hæmoglobin, which is carried by special blood cells and by combining reversibly with oxygen acts as the vehicle by which the latter is transported. Among Arthropods this function is generally

performed by the quite different pigment, hæmocyantin, which is pale blue when oxidized, and contains copper instead of iron. Reduced hæmocyantin is colourless.

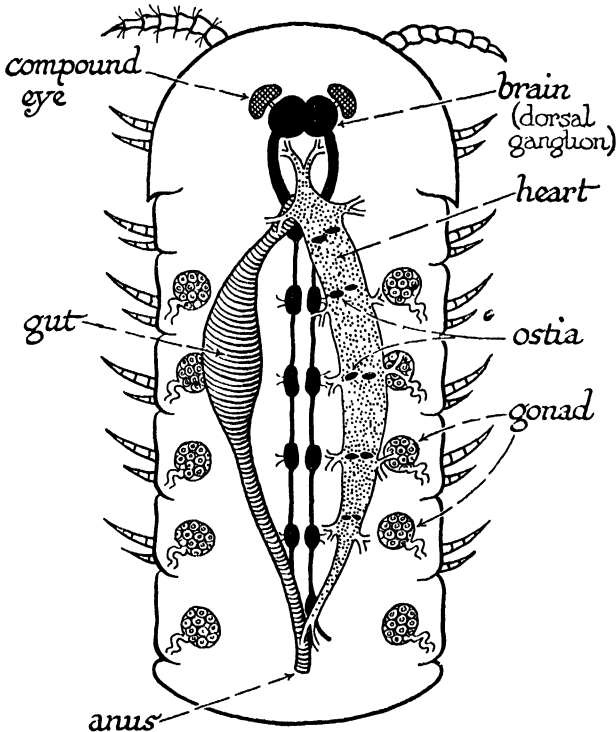

FIG. 108—DIAGRAMMATIC REPRESENTATION OF AN IDEAL ARTHROPOD

The circulatory organs of the Arthropod types exhibit an entirely unique arrangement. There is a large muscular heart lying above the alimentary canal. This heart (Fig. 108), has a paired series of valvular apertures known as *ostia* on either side of it. The heart pumps blood out to the tissues by arteries which are chiefly derived from two main trunks from the anterior and posterior end of the heart respectively.

Thence the blood percolates into the tissue spaces which communicate ultimately with the body cavity in which the heart lies. The body cavity in which the organs lie is a blood space, and the heart fills itself at each beat from the surrounding fluid which enters it via the ostia. The Vertebrate circulation, on the other hand, is a closed system of vessels. It displays certain universal features within the group even in the adult, notably the important fact that the blood from the capillary bed of the alimentary canal passes via the hepatic portal vein to the liver, through whose capillaries it must pass on its way back to the heart.

Though there are striking differences between the circulatory systems of land and water vertebrates, the main plan of the arterial system is essentially similar at an early stage of development. This we have studied already (p. 145) and have noted its relation to the methods of respiration that exist in different types of Vertebrates. No such extreme differences are correlated with the different methods of breathing which occur in different Arthropods (Figs. 102 and 105). In insects the heart generally is very thin and the arterial system is well-nigh non-existent. The insect has a system of fine tubes lined by thin cuticle with annular thickenings. These tubes are known as *tracheæ*. These tracheæ ramify throughout the entire body, ending blindly in the deepest tissues. They communicate by paired apertures (spiracles or stigmata) on either side of the body, and air is kept in circulation by rhythmical movements of the abdomen that can be easily observed in a cockroach or locust. The oxygen content of the tracheæ goes down during activity, and the carbon dioxide production goes up. If we block the spiracles the oxygen intake of an insect falls to a small fraction of its normal dimensions. Thus oxygen is brought to the tissues

directly in insects, which therefore have no need for a rapid efficient circulation.

Tracheæ are also found in centipedes and millipedes, and in spiders and ticks. They do not occur in scorpions or in the crayfish. The third, fourth, fifth, and sixth abdominal segments of the scorpion each have a pair of slit-like apertures on the ventral surface. These slits lead into sacs called book lungs, on account of the fact that the internal wall (Fig. 103) is thrown into thin plate-like projections overlapping like the leaves of a book. They offer a large surface for the diffusion of respiratory gases. Experiment shows that if the apertures of the book lungs are sealed, the oxygen consumption of the scorpion is very greatly reduced. So they are the main seat of oxygen intake, like our own lungs.

The crayfish has respiratory organs of another type. Superficial examination reveals a large space between the bases of the legs and a downward projection of the dorsal wall of the cephalothorax on either side. These lateral gill chambers, as they may be called, are open to the exterior by fairly wide apertures at the sides of the mouth. The cavity of the chamber is largely taken up by tufts of fine filaments springing from the bases of the legs and resembling a test tube brush in arrangement. These are the "gills." Water is kept constantly circulating over them by the incessant rhythmical motion of a plate-like extension of the base of the third masticatory appendage (second maxilla) which constitutes a baler, sometimes referred to by the technical term *scaphognathite*. If the baler is removed the oxygen consumption of the animal immediately sinks to negligible proportions. So we may conclude that the main surface for diffusion of oxygen from the water into the body is provided by the gill filaments.

Our survey of the physiological anatomy of terrestrial, aquatic, and aerial Vertebrates, and terrestrial, aquatic, and aerial Arthropods may be summed up as follows. In every aspect of structure the terrestrial Arthropod shares certain features of clear similarity with the aerial or aquatic Arthropod, and does not share them with the terrestrial Vertebrate. In every aspect of structure the aerial Vertebrate shares with an aquatic Vertebrate or with a terrestrial Vertebrate, certain features it does not share with an aerial Arthropod. On this basis we are justified in grouping the three Vertebrate types and the three Arthropod types in two separate assemblages based on underlying similarity *independent of the mode of life they pursue*, and we are thus forced to seek some non-teleological interpretation of the similarities which animals display.

Classifications of Lamarck and Cuvier.—A very fundamental similarity thus exists between the representatives of three great classes of Vertebrates on the one hand, and three representatives of what we now call Arthropods on the other. The recognition of this unity is foreshadowed in the classification of animals given by Lamarck (1808) fifty years after the publication of the *Systema Naturæ*. Lamarck departs so far from the anthropocentric point of view of Linnæus as to create a major assemblage, the Vertebrata, to include the four first classes of Linnæus' six divisions of the animal kingdom. Lamarck also split up Linnæus' order Insecta and adopted the two classes Arachnida and Crustacea, from which we have selected two of the types discussed above, but he included in the Arachnida a certain number of what are to-day regarded as wingless insects and the centipedes and millipedes. Below is given the classification of Lamarck:

A. INVERTEBRATA

1. "Apathetic" animals

Class I. Infusoria

Class II. Polypi (this includes Hydroids, Rotifera, Polyzoa, some Echinoderms)

Class III. Radiaria (jellyfishes, sea anemones, starfishes, and sea urchins)

Class IV. Tunicata (present group)

Class V. Vermes (non-segmented worms)

2. "Sensitive" animals

Class VI. Insecta (Linnæan orders maintained)

Class VII. Arachnida

Class VIII. Crustacea

Class IX. Annelida (segmented worms)

Class X. Cirripedia (barnacles)

Class XI. Conchifera (clams)

Class XII. Mollusca

Orders: Pteropoda; Gastropoda, Cephalopoda, Heteropoda, Trachelipoda

B. VERTEBRATA. "Intelligent" animals

Class XIII. Pisces

Class XIV. Reptilia (= Linnæus' "Amphiba")

Class XV. Aves

Class XVI. Mammalia

In the system of Lamarck we see the introduction of many terms that have been incorporated in modern schemes of classification. The outstanding positive feature is the recognition of unity of type within the Vertebrate series. While correctly recognizing the heterogeneity of Linnæus' "Insecta," Lamarck fails to grasp the fundamental similarity of the three great classes of Arthropods which he now denotes by the terms "Insecta," "Arachnida" and "Crustacea." The modern term Arthropoda was introduced by von Suboid in 1845. As the phylum is now defined arthropods are *segmented* animals in which the nervous

system has the same relations as in segmented worms (*vide infra*), i.e. a large pair of ganglia situated dorsally in the preoral segment, and connected on either side with a double chain of ganglia more or less approximated ventrally beneath the alimentary canal. The body cavity, however, is a blood space which communicates with the dorsal median heart by paired valvular ostia. With the single exception of the

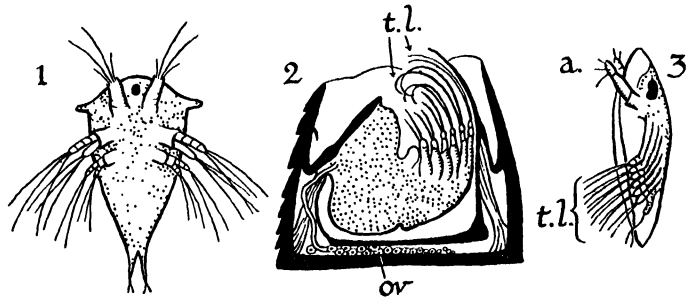

FIG. 109—THE BARNACLE

(1) The Nauplius or first larval phase with median eye and three pairs of biramous appendages, characteristic of the larvæ of many orders of Crustacea; (2) Vertical section through whole adult showing shell, plates, and six pairs of biramous jointed thoracic limbs (t.l.); (3) The Cypris or second larval phase which has in addition to the antennæ (A) and masticatory appendages, six pairs of biramous swimming limbs (t.l.)

aberrant genus, *Peripatus*, they have jointed limbs with separate muscles. The group may be divided into the following classes:

1. *Trilobita* (primitive and exclusively fossil)—Segments are alike bearing biramous (two-branched) appendages with masticatory bases, except the preoral pair which are antenniform.

2. *Crustacea*—These resemble trilobites most closely. Some segments bear biramous appendages. They have two pairs of antennæ and mandibles and are mostly marine, e.g. shrimps, lobsters, crabs, wood lice, pill bugs, water fleas.

3. *Arachnida*—No antennæ, no mandibles. Six or seven pairs of appendages in front of the genital orifice. The first pair are typically

chelate (i.e. pincers) and are called *chelicerae*. At least four of the remaining pairs are walking legs, e.g. king crabs, scorpions, spiders, mites, and ticks.

4. *Insecta (Hexapoda)*—One pair of antennæ and mandibles. Three pairs of walking legs, e.g. bugs, flies, beetles, wasps and bees, butterflies, termites.

5. *Myriapoda*—One pair of antennæ and mandibles. All segments behind the head alike and bear walking legs, e.g. centipedes and millipedes.

The majority of Arthropods belong to the two groups *Crustacea* and *Hexapoda*. Keys to the classification of these classes are given in the Appendix, pp. 389–394. The Vertebrate phylum is customarily divided at the present time into five principal classes; and an additional group, the Cyclostomes, which resemble the fishes in most essentials of their general organization (e.g. their circulatory system is of the Piscine type) but are separated from them more especially on account of the absence of any trace of jaws or limb structures.

A. WITHOUT LIMBS OR JAWS

(i) *Cyclostomes* (Lampreys and hagfish)

B. WITH FINS SUPPORTED BY FIN RAYS

(ii) *Pisces* (true fishes)

C. WITH FIVE-FINGERED LIMBS

(1) With functional aquatic respiration at some stage and undivided ventricle; no bony chest

(iii) *Amphibia* (frogs, toads, salamanders)

(2) No aquatic respiration:

(a) Ventricle incompletely divided (except in crocodiles), two aortic arches, external covering of scales

(iv) *Reptilia* (lizards, tortoises, crocodiles, snakes)

(b) Ventricle completely divided. Right aortic arch only persists; external covering of feathers

(v) *Aves* (birds)

- (c) Ventricle completely divided. Left aortic arch only persists; muscular diaphragm; three ear ossicles; external covering of hair
- (vi) *Mammalia* (kangaroo, bat, whale, dog, horse, rabbit, man)

TOPICS FOR HOME STUDY

1. Illustrate the Principle of Unity of Type by reference to Vertebrates and Arthropods which pursue different or similar habits of life.
2. Compare the structure, nutrition and respiratory mechanisms of Vertebrates and Arthropods.
3. Contrast the plan of the central and peripheral nervous system of Vertebrates and Arthropods.

CHAPTER XI

UNITY OF TYPE AMONG INVERTEBRATES

THE Principle of Unity of Type has been illustrated in the foregoing chapter by comparison of Arthropods and Vertebrates which pursue different or similar habits of life. We shall now examine it in relation to the systematic study of other groups of animals.

In Cuvier's *Le Regne Animal* (1829) the Arthropods are associated with another group, the *Annelida*, or segmented worms, in one of the major divisions of the animal kingdom, and several new groups based on Unity of Type make their appearance for the first time. Cuvier's classification was as follows:

FIRST BRANCH: ANIMALIA VERTEBRATA

Class I. MAMMALIA

Orders: *Bimana*, *Quadrumana*, *Carnivora*, *Marsupialia*, *Rodentia*, *Edentata*, *Pachydermata*, *Ruminantia*, *Cetacea*

Class II. BIRDS

Orders: *Accipitres*, *Passeres*, *Scansores*, *Gallinæ*, *Grallæ*, *Palmipedes*

Class III. REPTILIA

Orders: *Chelonia*, *Sauria*, *Ophidia*, *Batrachia*

Class IV. FISHES

Orders: (a) *Acanthopterygii*, *Abdominales*, *Subbrachi*, *Apodes*, *Lophobranchii*, *Plectognatha*; (b) *Sturiones*, *Selachii*, *Cyclostomi*

SECOND BRANCH: ANIMALIA MOLLUSCA

Class I. CEPHALOPODA

Class II. PTEROPODA

Class III. GASTROPODA

Orders: *Pulmonata*, *Nudibranchia*, *Inferobanchia*, *Heteropoda*,
Pectinibranchia, *Tubulibranchia*, *Scuti branchia*, *Cyclo-*
branchia

Class IV. ACEPHALA

Orders: *Testacea*, *Tunicata*

Class V. BRACHIOPODA

Class VI. CIRRHOPODA

THIRD BRANCH: ANIMALIA ARTICULATA

Class I. ANNELIDES

Orders: *Tubicolæ*, *Dorsibranchiæ*, *Abranchiæ*

Class II. CRUSTACEA

Orders: (a) Malacostraca: *Decapoda*, *Stomapoda*, *Amphipoda*,
Læmodipoda, *Isopoda*; (b) Entomostraca: *Branchiopoda*,
Pæcilopoda, *Trilobiteæ*

Class III. ARACHNIDES

Orders: *Pulmonariæ*, *Tracheariæ*

Class IV. INSECTA

Orders: *Myriapoda*, *Thysanura*, *Parasita*, *Suctoria*, *Coleoptera*,
Orthoptera, *Hemiptera*, *Neuroptera*, *Hymenoptera*, *Lepi-*
doptera, *Rhipiptera*, *Diptera*

FOURTH BRANCH: ANIMALIA RADIATA

Class I. ECHINODERMS

Orders: *Pedicellata*, *Apoda*

Class II. INTESTINAL WORMS

Orders: *Nematoidea*, *Parenchymatosa*

Class III. ACALEPHÆ

Orders: *Simplices*, *Hydrostaticæ*

Class IV. POLYPI (including the *Cælenterata* of modern authorities and the *Polyzoa*)

Orders: *Carnosi*, *Gelatinosi*, *Polypiarîi*

Class V. INFUSORIA

Orders: *Rotifera*, *Homogenea* (this includes the *Protozoa* of recent writers and *Protophyta*)

Though most modern authors prefer to retain the term Arthropoda because all the classes mentioned on p. 288 share many structural characteristics which distinguish them from all *Annelida*, many subsequent zoologists have followed Cuvier in making a super-phylum to include both. One reason for this is the existence of a small group of closely related genera (*Peripatus*, *Peripatopsis*, etc.) which occupy a position midway between the two groups.

The Segmented Worms.—The Annelida are externally segmented animals without limbs, but typically provided on either side in each segment with a tuft of bristles or setæ which serve for progression. The integument, which is covered externally with a thin layer of chitin, consists of an epidermis of one cell-layer together with an outer circular and inner longitudinal layer of muscles, and encloses a capacious cavity which is lined by secretory epithelium like the peritoneum of the Vertebrate. The alimentary canal runs from one end of the body to the other. The central nervous system is of the same type as that of arthropods. A large pair of ganglia, situated dorsally in the preoral segment, connect on either side with a double chain of ganglia in each segment more or less approximated ventrally beneath the alimentary canal (Fig. 110). The main trunks of the blood system are longitudinal vessels running above and below the gut and connected by annular vessels in each segment. The blood generally contains hæmoglobin. The gonads are present in several, sometimes in all, segments, in pairs, and discharge their products into the body cavity, whence they are conveyed by segmental ducts to the exterior. A paired series of segmental tubules, the *nephridia*, thought to be of an excretory character, open to the exterior and end either blindly in flame-cells like those of flat-worms (*vide*

infra) or by ciliated apertures into the body cavity. Annelids provide the most perfect examples of metameric segmenta-

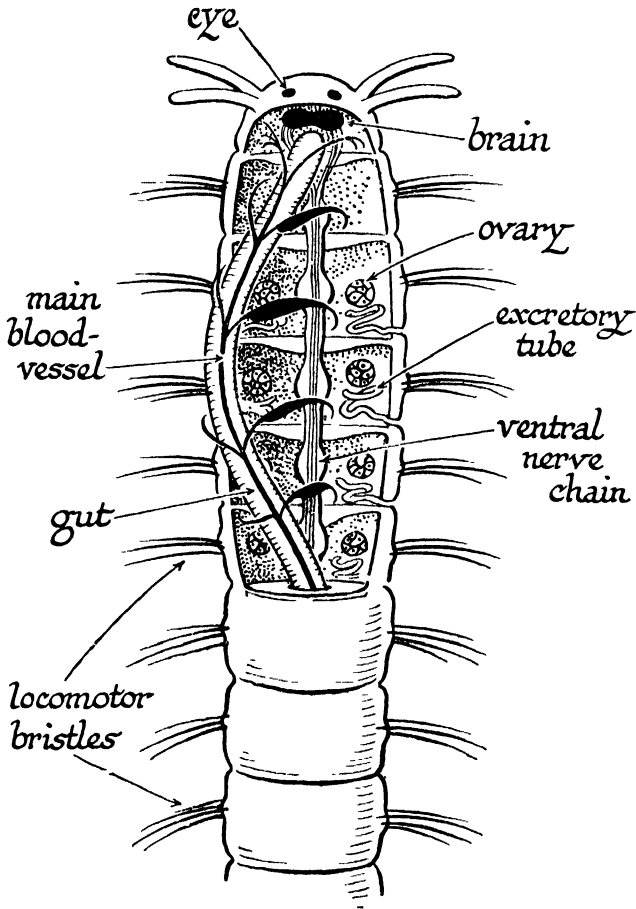

FIG. 110—DIAGRAMMATIC REPRESENTATION OF AN IDEAL POLYCHÆTE

tion, i.e. the repetition of structure along the main axis of the body, in the animal kingdom. The phylum Annelida include the marine bristle worms, the earthworms, and leeches, and are customarily classified as follows:

1. *Polychæta*—Marine worms with numerous setæ, usually projecting from cushion-like prominences on the side of the body, called parapodia. Often the preoral segment bears eyes and tentacles. The gonads are not localized, e.g. Nereis, Aphrodite, Arenicola, Bispira, Sabellaria.

2. *Oligochæta*—Earthworms and a few freshwater worms. Few bristles, no parapodia, eyes and tentacles never present. Hermaphrodite, gonads localized (i.e. restricted to certain segments), eggs laid in a cocoon, e.g. Lumbricus.

3. *Hirudinea*—Leeches. All semi-parasitic or blood-sucking. With few exceptions they have lost their setæ and the body cavity



FIG. III—PERIPATUS CAPENSIS

Drawn from life. Life size. (After Sedgwick.)

is largely replaced by connective tissue. They differ from the earthworms chiefly in possessing a sucker by which they adhere to their host or victim, and also in that each segment, corresponding to a nerve ganglion, etc., is externally divided into numerous rings, e.g. Hirudo.

To these classes must be added a number of minor groups (Echiuroidea, Myzostomida) which include very few animals.

As already stated, one aspect of the Principle of Unity of Type is the existence of isolated types which bridge the gulf between clearly defined classes or phyla. A good example of such intermediate types is *Peripatus* and a few closely allied genera of cryptozoic habit found in various parts of the

world where it is warm. In appearance *Peripatus* at the same time reminds one of a millipede and of a leech. Although it is commonly placed among the Arthropods, because it has an *ostiate* heart and a *tracheal* system, the general plan of its neuromuscular organization is essentially annelid. Externally it is not segmented, and the trunk limbs which are all alike have no joints. Internally it has a pair of excretory ducts in each segment, like a worm. The intermediate position which *Peripatus* occupies will be seen from the ensuing summary of the features which annelids share with Arthropods and the characteristics which distinguish the two groups:

1. The Annelida and Arthropoda include all animals with *both**
 - (a) Metameric segmentation.
 - (b) A central nervous system consisting of a dorsal brain and paired *ganglionated* nerve chains more or less closely approximated in the mid *ventral* line.
2. The Annelida differ from all Arthropoda (including *Peripatus*) in having—
 - (a) true intracellular centripetal *nephridia*.
 - (b) a closed vascular system.
 - (c) complete segmentation.
3. *Peripatus* agrees with Arthropods and differs from all worms in that—
 - (a) the dorsal blood vessel is ostiate.
 - (b) the body cavity is a blood space.
 - (c) it has trachea like those terrestrial Arthropods (*Query*: What is homology? *vide* pp. 382–3).
 - (d) the centro-locithal egg is meroblastic. That is to say, the storage material of the egg is concentrated at the centre, and segmentation which occurs over the whole surface does not involve the splitting of the central core of yolk.

* Contrast above with (i) Cestoda, (ii) Amphioxus.

4. *Peripatus* agrees with Annelids and differs from all other Arthropods in having—
- (a) a uniformly thin cuticle.
 - (b) a continuous sheet of circular muscle of the smooth (*plain*) type, commonly associated with slow walking movement.
 - (c) unjointed hollow limbs like parapodia.
 - (d) ciliated gonaducts.
5. All other Arthropods differ from Annelids in that—
- (a) Alternate thickening of the cuticle of body and limbs with telescopic invagination of the thickened parts provide exoskeletal attachment for discrete muscles executing localized movement.
 - (b) The segmental musculature is of striped fibres, i.e. the type characteristic of rapid localized movements.
 - (c) The appearance of localized motor activity is also associated with the presence of compound eyes in some representatives of each class.

The union of Annelids with Arthropoda as phyla within a super-phylum was adopted by the French zoologist Henri Milne-Edwards in 1855. In his classification another phylum based on Unity of Type acquires its modern boundaries. The classification of Milne-Edwards is as follows:

FIRST BRANCH: OSTEOZOARIA OR VERTEBRATA

SUB-BRANCH I. ALLANTOIDIANS

Class I. MAMMALIA

Orders: (a) Monodelphia: *Bimana*, *Quadrupana*, *Cheiroptera*, *Insectivora*, *Rodentia*, *Edentata*, *Carnivora*, *Amphibia*, *Pachydermata*, *Ruminantia*, *Cetacea*; (b) Didelphia: *Marsupialia*, *Monotremata*

Class II. BIRDS

Orders: *Rapaces*, *Passeres*, *Scansores*, *Gallinæ*, *Grallæ*, *Palmipedes*

Class III. REPTILES

Orders: *Chelonia*, *Sauria*, *Ophidia*

SUB-BRANCH 2. ANALLANTOIDIANS

Class I. BATRACHIANS

Orders: *Anura*, *Urodela*, *Perennibranchia*, *Cæciliæ*

Class II. FISHES

Section 1. *Ossei*Orders: *Acanthopterygii*, *Abdominales*, *Subbranchii*, *Apodes*,
Lophobranchii, *Plectognathi*Section 2. *Chondropterygii*Orders: *Sturiones*, *Selachii*, *Cyclostomi*

SECOND BRANCH: ENTOMOZOA OR ANNULATA

SUB-BRANCH I. ARTHROPODA

Class I. INSECTA

Orders: *Coleoptera*, *Orthoptera*, *Neuroptera*, *Hymenoptera*,
Lepidoptera, *Hemiptera*, *Diptera*, *Rhipiptera*, *Anopleura*,
Thysanura

Class II. MYRIAPODA

Orders: *Chilognatha* and *Chilopoda*

Class III. ARACHNIDA

Orders: *Pulmonaria* and *Trachearia*

Class IV. CRUSTACEA

Section 1. *Podophthalmia*Orders: *Decapoda* and *Stomapoda*Section 2. *Edriophthalmi*Orders: *Amphipoda*, *Læmodipoda*, and *Isopoda*Section 3. *Branchipoda*Orders: *Ostracoda*, *Phyllopoda*, and *Trilobitæ*Section 4. *Entomostraca*Orders: *Copepoda*, *Cladocera*, *Siphonostoma*, *Lernæida*,
*Cirripedia*Section 5. *Xiphosura**

SUB-BRANCH 2. VERMES

Class I. ANNELIDA

Class II. HELMINTHES

* To-day an order of Arachnida: it includes the King Crabs.

Class III. TURBELLARIA

Class IV. CESTOIDEA

Class V. ROTATORIA

THIRD BRANCH: MALACOOZOA OR MOLLUSCA

SUB-BRANCH 1. MOLLUSCA proper

Class I. CEPHALOPODA

Class II. PTEROPODA

Class III. GASTROPODA

Class IV. ACEPHALA (= PELECYPODA or LAMELLIBRANCHIATA)

SUB-BRANCH 2. MOLLUSCOIDEA

Class I. TUNICATA

Class II. BRYOZOA

FOURTH BRANCH: ZOOPHYTES

SUB-BRANCH 1. RADIARIA

Class I. ECHINODERMA

Class II. ACALEPHA

Class III. CORALLARIA or POLYPI

SUB-BRANCH 2. SARCODARIA

Class I. INFUSORIA

Class II. SPONGIARIA

The Mollusca.—The modern phylum *Mollusca* which corresponds to the "mollusca proper" in the preceding arrangement illustrates Unity of Type in a more sophisticated way than the examples we have already studied. Darwin refers to it when he writes:

Nothing can be easier than to define a number of characters common to all birds; but with crustaceans any such definition has hitherto been found impossible. There are crustaceans at the

opposite ends of the series which have hardly a character in common, yet the species at both ends, from being plainly allied to others and these to others and so onwards, can be recognized as unequivocally belonging to this and to no other class.

The characteristics which justify zoologists in placing the several classes assigned to it in the single phylum Mollusca cannot be summed up adequately by a few well-defined and entirely specific characteristics. Faced with the snail, the oyster, and the octopus as three molluscan types, the student may well be puzzled to see any such uniformity of structural peculiarities as we have encountered in the scorpion, the cockroach, and the crayfish as examples of the Arthropoda. Yet the unity of the group is very clear, when we study a large number of species. Thus the nautilus is clearly similar in its general organization to the octopus, and the nautilus is not such a far cry from the whelk. The snail is clearly similar to the whelk, the whelk to the limpet, and the limpet in many respects resembles a clam, like *Nucula*, that has a typical molluscan gill (*ctenidium*), though the resemblance of a snail to an oyster or mussel is not so obvious. So the zoological student who makes his first study in the field after a preliminary acquaintance with text-book definitions may be disappointed to find that the exceptions at first sight seem to be as numerous as the rules.

To-day by general agreement the group includes two of the Cuvierian classes whose names appeared in Lamarck's scheme (Cephalopoda and Gastropoda), the former including squids, octopus, etc., the latter snails, limpets, slugs. In addition it includes Lamarck's separate class "Conchifera," since usually called Lamelibranchiata (the term used in Owen's lectures, 1855) or *Pelecypoda* by some contemporary authors. These were included along with the Tunicata

that are now regarded as allied to Vertebrates in Cuvier's term Acephala. Cuvier's Pteropoda are now regarded as an order of Gastropods. Of the Brachiopoda and Cirripoda (Cirripedia) we shall speak later. They have only the most superficial resemblance to the three major classes of

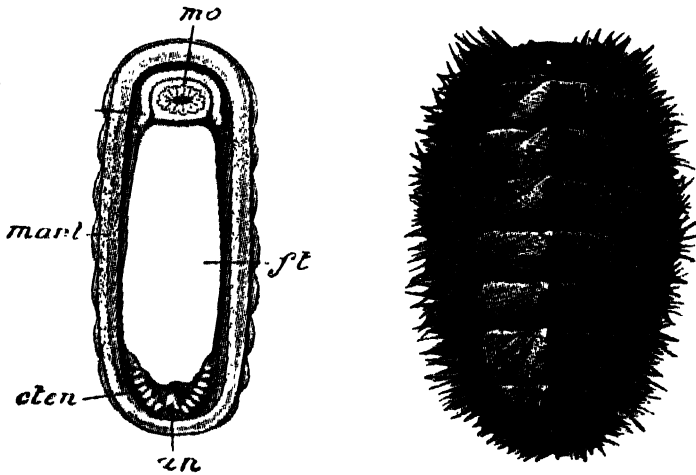

FIG. 112—CHITON

Right, from above; left, from below. *mo*—mouth; *mant*—edge of mantle; *ft*—foot; *cten*—gill; *an*—anus.

Mollusca (Cephalopoda, Gastropoda, and Lamellibranchiata). When we compare it with Linnæus' order of the same name, an assemblage which took in sea anemones, sea cucumbers, jellyfishes, most free living worms, we see that Cuvier's Mollusca was a genuine step towards the recognition of Unity of Type.

In the modern phylum Mollusca two classes have been separated from the older Gastropoda. These are the Iso-pleura, or chitons, and the Scaphopoda, or elephant-tusk-shells.

The last is a small isolated group which will not be mentioned further. *Chiton* (Fig. 112) is important because it occupies a place among the various classes of molluscs somewhat like that of *Peripatus* in the super-phylum *Annulata*, particularly in so far as it shares features common

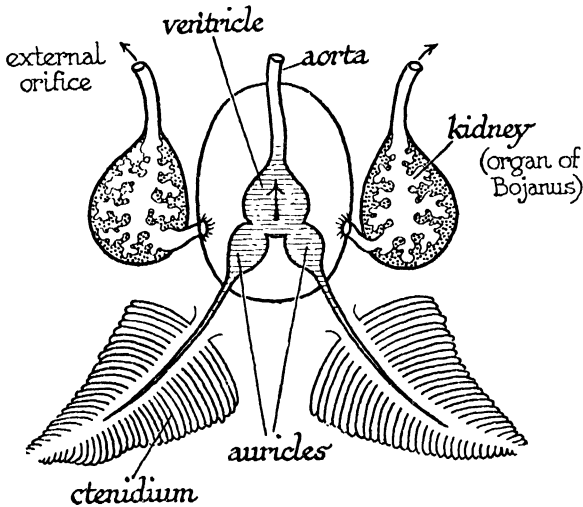

FIG. 113—GENERALIZED VIEW OF THE MOLLUSCAN VISCERAL CONSTELLATION

to the clams (Pelecypoda) and to such marine Gastropods as the limpets.

Molluscs, like Vertebrates, Arthropods, and Annelids, have a gut with mouth and anus, a well-developed C.N.S., and a circulatory system. The central nervous system is mainly concentrated in a ring of ganglia around the mouth (as in Arthropods and Annelids). The heart with at least two chambers lies in a body-cavity dorsal to the alimentary canal and communicates by a ciliated funnel with two (sometimes one or occasionally four) glandular organs, the so-

called kidneys, which also communicate with the exterior. In many Molluscs the ventral aspect of the body is thick and muscular and constitutes a creeping foot. Typically also, there grows out from the side of the body a thin fold of integument known as the mantle, bounding a depression known as the mantle-cavity, in which are suspended one or more pairs of ctenidia or "gills." The ctenidium consists of a thicker axis with a series of thin plates on either side. Blood

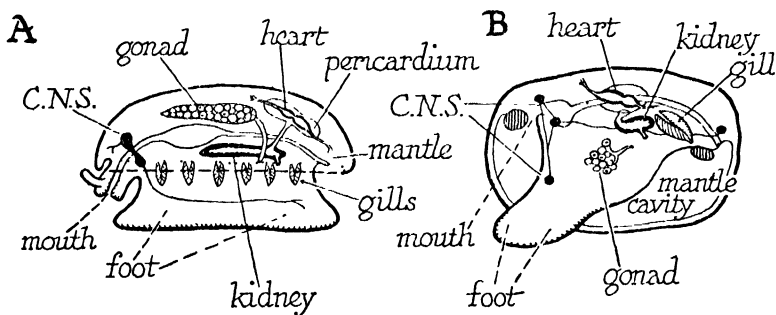

FIG. 114—UNITY OF TYPE IN MOLLUSCA

Comparison of anatomy of A. Chiton and B. a Bivalve.

passes from the more muscular "ventricular" part of the heart by arteries to the tissues, thence to the gills, and from the gills by veins returns directly to the thinner auricular portion of the heart. Thus the heart contains oxygenated blood and not de-oxygenated blood as in fishes.

This visceral constellation of organs, the chambered heart, the ctenidia which return blood to it, and the kidneys which open into the pericardium which surrounds it, is the most generalized feature of molluscan organization. It is a structural characteristic of all Cephalopods, of marine Gastropods, and of some typical Pelecypods. As drawn in Fig. 113, it is not a universal property of the phylum.

Chiton has many pairs of ctenidia, and some Cephalopods have two pairs. Most marine Gastropods have only *one* gill,

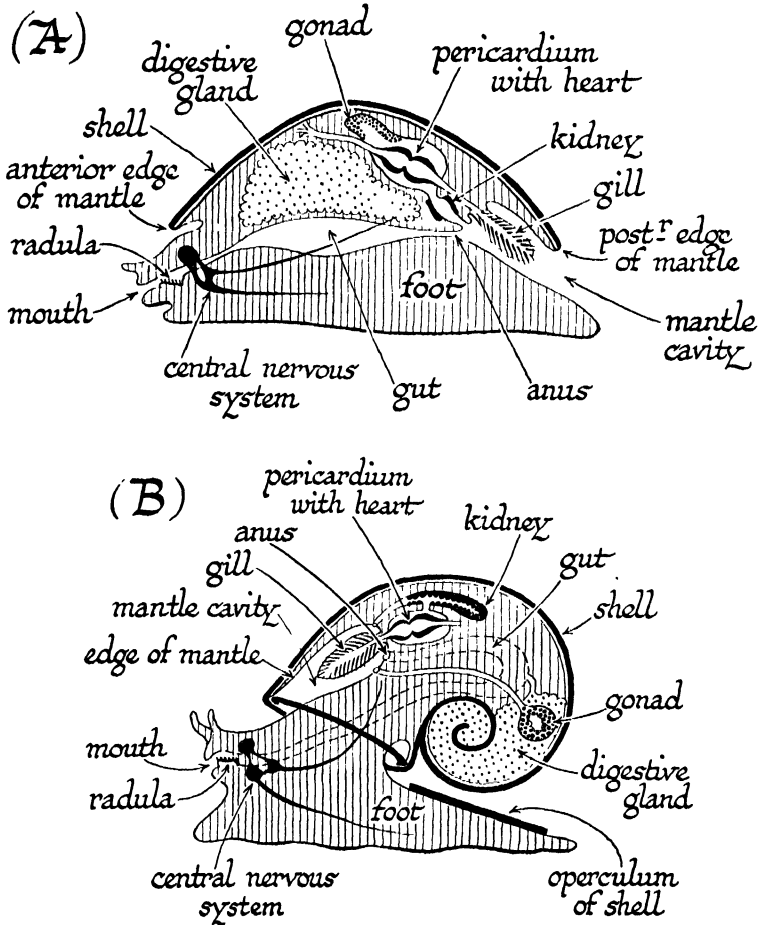

FIG. 115—(A) HYPOTHETICAL COMMON ANCESTOR OF CEPHALOPODS AND GASTROPODS, (B) SHOWING TORTION OF THE BODY IN A MODERN GASTROPOD

one auricle, and *one* kidney. The terrestrial species (e.g. snails and slugs) have lost the ctenidium altogether. Though

a few small clams (e.g. *Nucula* and *Yoldia*) have a ctenidium like that of Chiton, an octopus, or a whelk, what is called the *ctenidium* of most clams, such as the oyster, cockle, or mussel, would not be described by the same name, if it

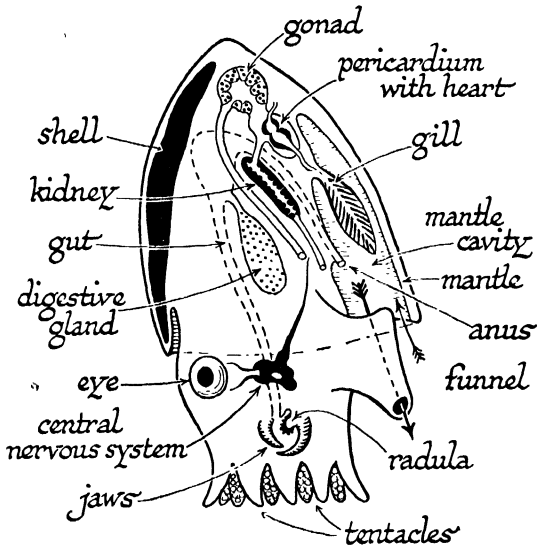

FIG. 116—CEPHALOPOD

In *Cephalopods* such as the cuttle-fish and the octopus the body has been pulled out in a dorsi-ventral direction. The foot has been made into tentacles and a funnel through which water can be shot out to propel the animal along. The shell is usually enclosed by the mantle and the radula is supplemented by horny jaws.

were not for the existence of intermediate types which connect them with *Nucula* or *Yoldia*. The typical Pelecypod gill is not a respiratory organ. As explained earlier on p. 60, it is a ciliary food strainer. The axis of the gill is fused along its entire length with the mantle groove, and the long, fine filaments which hang down like a baize curtain are reflexed.

A few marine Gastropods such as the slipper limpet

(*Crepidula*) also use their gills in this way, and in such species, as in many Pelecypods, there is a highly characteristic device called the *crystalline style* for dealing with the carbohydrate content of the diatom-diet of these animals. It is a gelatinous rod impregnated with starch-splitting enzyme and enclosed in a groove or sac of the gut. Most Gastropods, like Chiton and like all Cephalopods, take a more solid diet. They have a muscular tongue (*odontophore*) on which is mounted a characteristically molluscan structure called the *radula*. This is a ribbon of chitinous teeth for triturating their food. Many Gastropods and Cephalopods also have horny jaws.

Another characteristic feature of the group is the ciliated larva with its minute shell. It is called the *Veliger* (Fig. 117), and is sometimes preceded by a larval form which resembles the larva of marine worms, and is known as the *Trochophore* (Fig. 117). The heavily yolked eggs of the Cephalopods like the eggs of terrestrial gastropods (snails and slugs) do not hatch out as larvæ.

1. *Isopleura*.—The mantle-fold is co-extensive with the body, the mantle-cavity is shallow on either side carrying a paired series of ctenidia which hang freely. The foot is creeping and there is a distinct head, and odontophore and radula are present. A series of unpaired dorsal plates form the shell, e.g. Chiton.

2. *Pelecypoda*.—As in Chiton the mantle-fold is co-extensive with the body, but is much deeper, so that the mantle-cavity is wrapped round the foot. The two lobes of the mantle-fold secrete a bivalved shell. The head, odontophore and radula are completely absent. A pair of ctenidia are present, the axis being fused along its whole length with the mantle-ridge, and the filaments, which are very

numerous, hang downwards like a double curtain into the mantle-cavity. It is to this feature that the alternative name *Lamellibranchiata* refers. The gill of a typical clam is not obviously like that of other molluscs, but a series of forms connect the more specialized type of gill, which we have described in the case of the mussel (p. 60), characteristic of the majority of the group, with the more typical Molluscan ctenidium of the smaller clams like *Nucula*. To this class belong the oysters, mussels, cockles, etc.

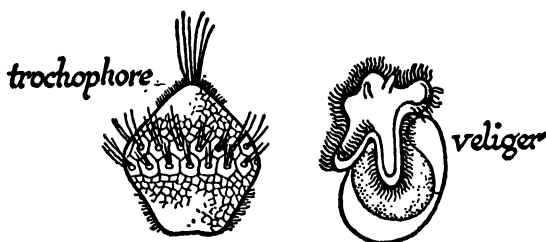

FIG. 117—CILIATED LARVÆ OF MOLLUSCS—TROCHOPHORE AND VELIGER

3. *Scaphopoda*.—The Scaphopods in general plan of organization are very much like the Lamellibranchs, but the folds of the mantle-cavity fuse below the foot and secrete a continuous cylindrical shell. The ctenidia have been lost. There is a vestigial head and odontophore but no radula, e.g. *Dentalium*.

4. *Gastropoda*.—These possess a well-developed head bearing tentacles and eyes and a creeping foot like that of *Chiton*, also an odontophore with radula. In early development the mantle-cavity is confined to the posterior region, but as development proceeds the visceral mass becomes twisted through two right angles so that eventually the mantle-cavity, anus, etc., are directed forwards. There is generally a spiral shell. In the primitive forms there are

two ctenidia, more generally one, and in some forms, e.g. snails and slugs, they have been lost. This class includes, in addition to the last-named, the whelks, limpets, and sea slugs.

5. *Cephalopoda*.—The mantle-cavity is posterior and typically contains two ctenidia. The integument below the head is drawn out into elongated prehensile processes known as arms and also into a funnel-like opening for the mantle-cavity. There is nothing exactly like the creeping foot of *Chiton*. An odontophore and radula are present. The shell is single but is usually embedded in the dorsal wall, e.g. octopus, cuttle-fish, squids, etc.

A few of the characteristic features of the Mollusca described in the preceding survey are found in *some* members of all five groups. Others are found in more than one but not in all. Scarcely any are universal. The best way to emphasize the essential unity of type on which the recognition of the phylum is based is therefore to draw up a table such as that on page 309.

Leuckart's Classification of Animals.—A system which was published in Germany in the middle of the nineteenth century, a few years earlier than that of Milne-Edwards, introduces us to two new phyla, *Echinodermata* and *Cœlenterata*, as recognized to-day. Leuckart's system which does not include a detailed division of Vertebrates is as follows:

TYPE I: CŒLENTERATA

Class I. POLYPI

Orders: *Anthozoa* and *Cyclicozoa*

Class II. ACALEPHÆ

Orders: *Discophoræ* and *Ctenophoræ*

FEATURES COMMON TO THE DIFFERENT CLASSES OF
MOLLUSCA

A	B	C	D	E
Pelecypoda and Isopleura	Gastropoda and Isopleura	Gastropoda and Pelecypoda	Cephalopoda and Gastropoda	Cephalopoda and Pelecypoda
1. Dorsal visceral mass lying over a ventral muscular foot	Ditto	Ditto	—	—
2. Lateral mantle-folds in which ctenidia lie . .	—	—	Ontogenetically there is a posterior mantle	—
3. Above gut there is a heart lying in a <i>pericardium</i> and receiving blood from the gills	Ditto (when gills present)	Ditto	Ditto	Ditto
4. Pericardium communicates with paired, capacious glandular sacs (kidneys) which discharge to the exterior nitrogenous excreta	Ditto	Ditto	Ditto	Ditto
5.	Head with odontophore and radula	—	Ditto cephalization well-developed tentacles and eyes	—
6.	Primitive Gastropoda (e.g. Limpets) and Isopleura have nemertinean C.N.S.	—	—	—
7.	—	Some marine Gastropoda and most Pelecypoda are ciliary feeders and have a Crystal-line style	—	—

TYPE 2: ECHINODERMATA

Class I. PELMATOZOA

Orders: *Cistoidea* and *Crinoidea*

Class II. ACTINOZOA

Orders: *Echinida* and *Asterida*

Class III. SCYTODERMATA

Orders: *Holothuriæ* and *Sipunculida*

TYPE 3: VERMES

Class I. ANENTERÆTI

Orders: *Cestodes* and *Acanthocephali*

Class II. APODES

Orders: *Nemertini*, *Turbellarii*, *Trematodes*, and *Hirudini*

Class III. CILIATI

Orders: *Bryozoa* and *Rotifera*

Class IV. ANNELIDES

Orders: *Nematodes*, *Lumbricini*, and *Branchiati*

TYPE 4: ARTHROPODA

Class I. CRUSTACEA

Orders: *Entomostraca* and *Malacostraca*

Class II. INSECTA

Orders: *Myriapoda*, *Arachnida* (*Accra*, Latr.), *Hexapoda*

TYPE 5: MOLLUSCA

Class I. TUNICATA

Orders: *Ascidia* and *Salpæ*

Class II. ACEPHALA

Orders: *Lamellibranchiata* and *Brachiopoda*

Class III. GASTROPODA

Orders: *Heterobranchia*, *Dermatobranchia*, *Clepbbranchia*, *Palmopoda*, and *Cyclobbranchia*

Class IV. CEPHALOPODA

TYPE 6: VERTEBRATA

Echinoderms and Cœlenterates.—The Echinodermata, which include starfishes, sea urchins, feather stars, brittle stars, and sea cucumbers, share one feature with the Cœlenterata with which they are associated in Cuvier's classification. Both show a considerable measure—in some Cœlenterates complete—of radial as opposed to bilateral symmetry. In other respects they are very different.

Arthropods and Molluscs agree with Vertebrates in having

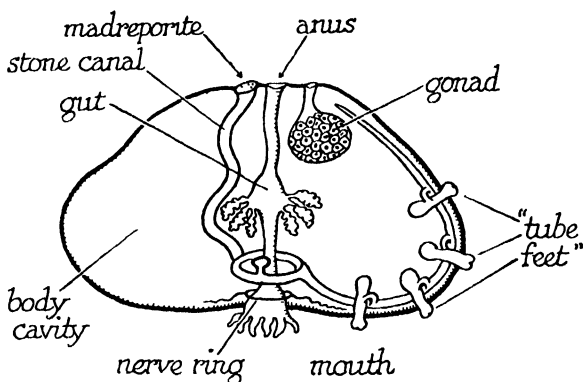

FIG. 118—DIAGRAMMATIC REPRESENTATION OF AN IDEAL ECHINODERM

a well-developed circulatory system. A rudimentary vascular system also exists in Annelids, Brachiopods, Nemertines, and in Phoronis. The Echinodermata represent a definitely lower grade of physiological organization and the classes, though differing in external form, have a close similarity in internal organization (Fig. 118). A muscular integument with a leathery external covering and outer layer of ciliated epithelium is strengthened internally with calcareous plates to which may be attached projecting spicules. It encloses a capacious body-cavity lined by secretory epithelium and developed as a pouch from the embryonic gut. The alimen-

tary canal with mouth and anus runs through this body-cavity. From grooves (typically *five*) on the external surface of the animal project a double row of hollow tentacles, each bearing a single sucker at its distal end. The cavities of these "tube feet" connect with a longitudinal vessel underlying each groove and discharging into a circular canal around the mouth. This canal communicates by a channel known as the stone canal with the exterior through a finely perforated plate, the madreporite. The gonads are arranged radially between the longitudinal canals of the tube-feet system, and communicate by short ducts directly with the exterior.

The group *Echinodermata* as defined by Leuckart included one class which is represented by a few species. The "Sipunculoidea" are a very isolated group. They have only the most superficial resemblance to any Echinoderm. With this exclusion, the existing forms are classified in five groups, all of which, except the Ophiuroidea, appear in Leuckart's scheme. These are:

1. ECHINOIDEA, e.g. sea urchins, heart and cake urchins, sand dollars
2. ASTERIOIDEA, e.g. starfishes
3. OPHIUROIDEA, e.g. brittle stars
4. HOLOTHUROIDEA, e.g. sea cucumbers
5. CRINOIDEA, e.g. feather stars

The animals with which we have dealt so far are sufficiently large to be studied by gross dissection, which the earlier anatomists combined in many cases with experiment to discover the significance of the organs they described in the economy of the organism. With the recognition of the cellular structure of animals in the thirties embryology received a new impetus. Methods for the study of minute animals by the examination of microscopic sections were

perfected, and new fields of comparative anatomy opened up. The microscopic study of tissues (histology) immensely facilitated the task of comparing the organization of the simpler and more complex types of animals, but unhappily it meant less reliance on experimental evidence. It became

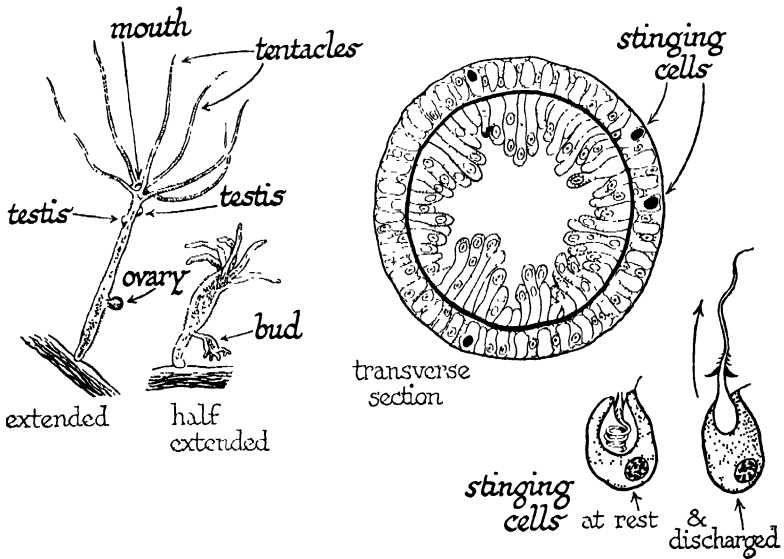

FIG. 119—HYDRA: A FRESHWATER POLYP
(The figure on the left is magnified from 10 to 20 times.)

more and more customary as time went on to recognize a nerve as a tissue which, when treated with certain reagents, stains in a particular way. The Cœlenterata afford an example of a group whose anatomical organization could not be clearly appreciated until improved microscopic technique had been brought to bear upon it.

A cursory study of the green Hydra (Fig. 119) will assist us to get a clear idea of the structural peculiarities of the Cœlenterata. This little organism which, when fully

extended, may attain about half an inch in length, is found clinging to freshwater plants. It appears to the eye as a thread of bright green hue attached at one end to some object and terminating in a tuft of delicate filaments (the tentacles) at the other. Sometimes it detaches itself and crawls by means of its tentacles which, when extended, may be twice as long as the rest of the body. When disturbed the whole animal, trunk and tentacles alike, shrinks into a swollen pear-shaped mass less than a fifth of its extended length. It seizes small water fleas by its tentacles and engulfs them through its single aperture, the mouth, seen under the microscope to be situated at the tip of a small cone separated from the rest of the trunk by the crown of tentacles. When examined in thin sections, prepared by embedding the animal in wax, as is usually done with such small forms, the body is seen to be tubular. Its wall, consisting of two clearly distinguishable layers, surrounds the cavity into which the food is thrust through the mouth. The innermost layer consists of large cells, some of which are ciliated. The outermost portion of the body wall consists of several layers of smaller cells. Some of these are like ordinary epithelial cells in other respects, but their internal surface is drawn out into long contractile processes, on which account they are called epithelio-muscular or myo-epithelial cells. Others especially abundant in the tentacles, and called stinging cells, contain ovoid vesicles like little flasks with the neck inverted. When the animal is disturbed these vesicles (nematocysts) thrust out their long filamentous necks, from the tip of which emerges a drop of a poisonous fluid. Between the epithelio-muscular cells and the innermost layer of the body there is a fine network of cells which stain like nerve tissue. This is called the *nerve net*, because experimental

evidence shows that the Cœlenterate nerve net is a form of conducting tissue.

From time to time cylindrical buds are formed on the sides of the trunk. These acquire a tuft of tentacles at the free end, and become detached to pursue an independent existence as new individuals. But in addition to this vegetative method of reproduction, true sexual reproduction occurs in Hydra. Cells of the outer layer of the body divide repeatedly, giving rise to sperms in the usual way, and the male gonad, which is seen as a prominence on any region of the trunk, is simply a mass of sperm covered by a thin pellicle of epithelial cells, which eventually becomes ruptured liberating the gametes. An ovary may be produced on the same individual. It consists of a single large ovum likewise covered by a thin epithelium on the outside of the body. The sperm penetrates the ruptured wall of the ovary. Both fertilization and early cleavage take place while the ovum is still attached to the body of the parent.

Budding occurs in many Cœlenterates and often the buds do not become detached, so that colonies are formed, as in such common rock pool zoophytes as *Obelia* and *Plumularia*. In these colonial forms the sexual organs are often developed on a special sort of bud, the *medusa*, which is more flattened in shape than the vegetative *hydroid*. The medusa is set free into the water and pursues an independent existence for a time, shedding its sexual products when they are ripe. Many colonial Cœlenterates secrete calcareous deposits around them. Such are the corals. Some, allied to Hydra, form colonies with large floats filled with gaseous products, the zooids being clustered on the underside of the float which drifts with wind and current. *Physalia*, the Portuguese man-of-war, or blue-bottle, is one of these. In one respect the

organization of Hydra is simpler than that of the larger Cœlenterata, the jellyfishes and sea anemones. It has no separate muscular system. Well-developed muscle fibres forming a continuous sheet in the outer portion of the body wall (jellyfishes) with, in addition, discrete bands in the inner portion (sea anemones) are often present in Cœlenterates. Again the gonads in the larger Cœlenterata are located in the digestive cavity. But in all they are simply proliferations of cells of the body wall, without any ducts or accessory structures. Stinging cells are always present, and the conducting tissue is of the diffuse type referred to as a nerve net. Separate afferent and efferent nerve fibres meeting in a central nervous system are never found.

The group Cœlenterata as defined by Leuckart included the sponges, which are now usually made a separate phylum, the Porifera. With this restriction the Cœlenterata may be defined as follows. They are cellular animals with one cavity, the digestive cavity, communicating with the exterior by a single aperture, the mouth. The walls of the body consist of two distinguishable layers. These two layers, the *ectoderm* and *endoderm*, are often separated by a thick gelatinous layer (*mesogloea*). In the cellular layers true muscle-fibres and conducting tissue may be differentiated, but there is never present either (a) a concentration of nervous elements to form a central nervous system, or (b) a system of reproductive ducts. The germ cells are formed superficially either from the ectoderm (Hydrozoa) or endoderm. From a physiological point of view the main feature is the absence of a mechanism of true reflex action. The majority of Cœlenterates are thus divided by modern authors:

1. *Hydrozoa*.—Gonads external, no gullet or gastric filaments, e.g. *Hydra*, *Phumularia*, *Obelia*, *Millepora*, *Physalia*.

2. *Scyphozoa*.—Gonads internal, typically with alternation of generations, but the medusoid the predominant form. The medusoid differs from the Hydrozoan medusoid, because it has internal gonads, and because it has gastric filaments provided with stinging cells which are the remains of radial partitions in the hydroid from which it is budded off along the longitudinal axis, e.g. *Aurelia*, *Halicyclstus* (sedentary), *Rhizostoma*.

3. *Actinozoa*.—Gonads internal, but individuals entirely sessile with no alternation of generations. There is a deep ectodermal gullet and the digestive cavity is divided incompletely below the gullet and completely above by radial partitions which are provided with thick longitudinal muscle bands, e.g. sea anemones and the majority of the corals.

A fourth group, the Ctenophora or comb-jellies, includes a few specialized forms with predominantly bilateral symmetry. In development of comb-jellies the body muscles are laid down at an early stage in embryonic life, as in more complex animals.

The *Porifera* or sponges formerly placed close to the Cœlenterata are only superficially like them, in so far as they represent a very low grade of physiological differentiation. They were regarded as animals by Aristotle, but they stand very much apart from all other animals, and such terms as *body*, *individual*, *colony* or the like have very little applicability to them. A sponge is a labyrinth of ciliated canals communicating by pores on the surface with the exterior. Between the canals is a gelatinous mass strengthened by horny fibres or spicules of calcareous or siliceous material, the exterior being invested in a thin epithelium in which distinct cell walls are absent. They have no nervous elements, and the reproductive organs are clusters of sperms or eggs embedded in the gelatinous coat. The sperm wriggles its way through the tissues of the sponge to the eggs embedded in them.

Vermes.—All the major phyletic divisions of animals were recognized by the middle of the nineteenth century with the exception of those groups which Leuckart placed together in “Vermes.” The main feature of systematic zoology in the second half of the nineteenth century was therefore the application of the Principle of Unity of Type to the sorting out of the constituent forms of this heterogeneous assemblage. A new concept in classification which now came into play more prominently was the attempt to express in a systematic form the ancestral relationships implied in the evolutionary doctrine, and implicit in the systematic scheme of Lamarck. The influence of this on zoological classification will be discussed later.

In a classificatory scheme put forward by Haeckel (1868) the same phyla (Haeckel’s term) as those of Leuckart were adopted, save for the textual difference that the Linnæan term “Zoophyta” replaced Cœlenterata, a practice in which Haeckel has not been followed by later writers. Haeckel’s classes, however, correspond much more closely with those of more modern taxonomists. The Tunicata are removed from the Mollusca to “Vermes.” And subsequent development has been mainly concerned with splitting up the latter into separate phyla, corresponding to its constituent classes in Haeckel’s scheme. These are notably: Annelida (p. 293), Nemathelminthes, Platyhelminthes, Rotifere (Rotatoria), Bryozoa (Polyzoa), and Tunicata.

The Flat-worms.—Like the Annelida, the *Platyhelminthes*, or flat-worms, are a well defined group. This phylum is very largely composed of parasitic forms, the life histories of which have been worked out with some difficulty in comparatively recent times. The Platyhelminthes, like the Cœlenterates, have one principal cavity, the digestive cavity communicating

with the exterior by a single aperture, the mouth. They have, however, no sign of radial symmetry. A somewhat elaborate system of generative organs which discharge their products to the exterior by gonaducts, provided with an elaborate

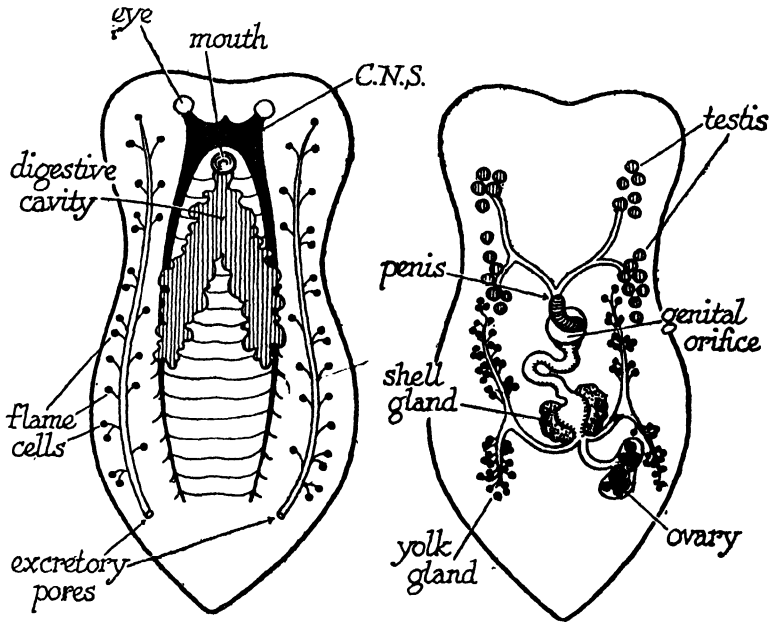

FIG. 120—DIAGRAMMATIC REPRESENTATION OF AN IDEAL FLAT-WORM Showing gut, nervous system and excretory organs on left, and reproductive organs on the right.

system of glands, constitutes the most characteristic feature of the group (Fig. 120). With one or two exceptions flat-worms are hermaphrodite. The oviduct generally receives the secretion of shell glands and a ramifying system of yolk glands which occupy a good deal of the internal space of the body. Between the muscular outer wall and the epithelium of the gut the interspaces are filled with a highly characteristic mass of vacuolated cells called parenchyma.

There is a ramifying system of intracellular tubules called the *nephridia*, communicating at one end with the exterior and ending at the other end blindly in cells with vibratile cilia which project into the lumen of the tube. They are called flame cells. In general all the Platyhelminthes are dorsoventrally compressed. A central nervous system is present and consists of a large anterior dorsal ganglion and lateral cords connected by transverse commissures below the gut. Three classes are now recognized within the group:

1. *Turbellaria*.—Free-living flat-worms in which the body is covered by a ciliated epithelium, some of the cells of which contain hyaline bodies known as rhabdites. The mouth is typically at the end of an eversible pharynx on the ventral side. They are found under rocks in fresh and marine water. A few live in mud, e.g. *Planocera*, *Planaria*, *Bipalium*.

2. *Trematoda*.—Parasitic flat-worms (flukes) in which the external epithelium after secreting a thick cuticle degenerates. The body is provided with suckers. A gut is present, e.g. *Distomum*, *Polystomum*, *Bilharzia*.

3. *Cestoda*.—The integument and reproductive organs are very similar to the Trematoda, but a digestive cavity is absent. They are all internal parasites (tape-worms), and generally the body is divided into a number of segments, each with a complete set of reproductive organs, e.g. *Tænia*.

The class *Nemertinea* in several respects show a considerable advance in structural complexity upon the flat-worms, for which reason they are elevated by some zoologists to phyletic rank. The elongated vermiform body with terminal mouth *and* anus has a rudimentary circulatory system. These features separate them from the foregoing classes. So does the peculiar eversible pharynx enclosed in a tubular sheath above the alimentary canal at the anterior end of the body. On the other hand, a clear relationship to the *Turbellaria* is seen in the ciliated epidermis, the cells of which contain

rhabdites, in the parenchymatous tissue that occupies the space between the gut and the integument, in the nephridia and nervous system. The Nemertinea occupy a very interesting position in the animal kingdom, in some respects intermediate between the Annelida and the Flat-worms, and they might well be conceived to be survivors of a group very closely related to the common stock of Annelids, Molluscs, and Arthropods.

Thread-worms.—Another group which includes species of great economic importance is the *Nemathelminthes*, or round-worms, which comprises both a large number of parasites, chiefly intestinal, and free living forms in sea water and damp soil. The majority of forms denoted by this term are included in a single class, Nematoda, and it is doubtful whether the other classes usually associated with them have any close resemblance (Nematomorpha, which occur as parasites in the intestines of insects, and Acanthocephala, gutless intestinal parasites in Vertebrates, with a hooked eversible proboscis). The Nematodes have an elongated body covered with a thin cuticle with terminal mouth and anus at the opposite extremity. They have a muscular pharynx, but the rest of the straight alimentary canal has a wall composed only of epithelium surrounded by cuticle. Between the integument and the gut is a capacious cavity in which the gonads and coiled gonaducts lie. The cavity is not lined by a secretory epithelium like the body cavity of an Annelid. The integument itself consists of a syncytium below the cuticle and a single layer of longitudinal muscles whose enormous protoplasmic processes with their nerve fibres project into the body cavity. The similarity between the body cavity (or cœlom) of segmented worms, Vertebrates, and Molluscs was a topic for much discussion and endless

speculation during the second half of the nineteenth century. The fact that the "coelom" arises in development in a different manner within the same group makes such discussion somewhat barren. To the Nematoda belong the horse thread-worm *Ascaris*, the miner's worm *Anchylostomum*, and other human parasites such as *Trichina*, *Filaria*, and *Oxyuris*, the pin-worm of children's stools. The remaining Vermes are isolated groups of little practical significance.

The *Rotifera* may be mentioned first, because they have always proved a source of attraction to amateur microscopists. For that reason they have been studied more thoroughly than most of the others. The Rotifera are minute animals found in fresh water the world over and occupy a very isolated position in the animal kingdom. Though of microscopic dimensions—the largest are only just visible to the naked eye—they have a comparatively complex organization. The body is of various shapes. Typically there is a circle of ciliated cells at the oral end. The alimentary canal is provided with mouth and anus and a gastric mill, but has no muscular wall. It lies in a capacious cavity in which nephridia with flame cells and gonads and gonaducts are also present. Both the latter open into the hind end of the gut. The C.N.S. is a circumoesophageal ring with a large bi-lobed dorsal ganglion. They are of no economic importance. Many are parthenogenetic, and like the social Hymenoptera produce their males by virgin birth and their females from fertilized eggs. Some, like the gall-flies, and a few fresh-water Crustacea, have a regular alternation of parthenogenetic and bisexual generations. The Rotifera attracted a good deal of attention at one time because of their superficial resemblance to the ciliated larvæ of Annelids, Molluscs, and Flat-worms.

The *Polyzoa* are colonial animals, which in the form of the colony and the zooids show a superficial resemblance to corals and hydroids, from which they were first separated by Vaughan Thompson. There is a circlet of tentacles round the oral end leading into the alimentary canal which is provided with an anus surrounded by a body cavity in which the gonads lie. The C.N.S. is represented by a small ganglion between mouth and anus. There is a ciliated larva somewhat like the trochophore larva of Annelids. Representatives of the group are common in rock-pools between tide marks. The Polyzoa

are of very uncertain affinities. Some authors, following Huxley, associate them with the lamp-shells or Brachiopoda which superficially resemble bivalve molluscs. Others merge both groups along with the classes Phoronidea and Sipunculoidea and certain other forms in a Phylum *Podaxonia*, or *Molluscoidea*.

The *Sipunculoidea* are vermiform organisms suggestive of Annelids. They differ, however, from the Annelida because they lack segmentation or setæ and because of the position of the anus,

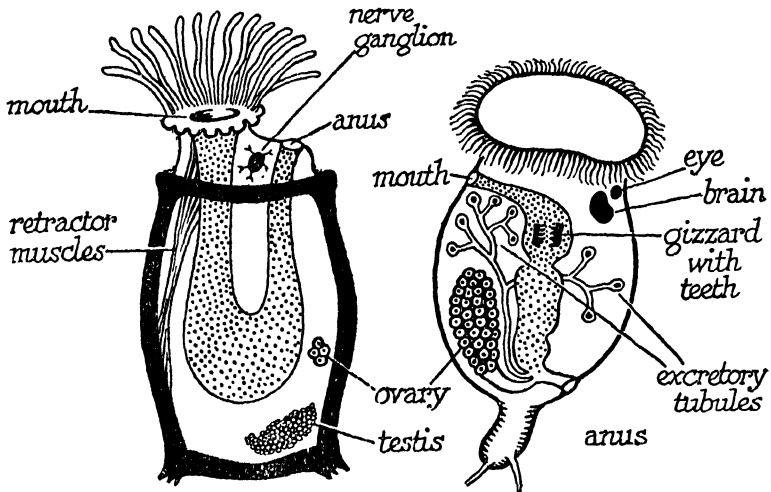

FIG. 121.—DIAGRAMMATIC REPRESENTATION OF A POLYZOAN (left) AND A ROTIFER (right)

which is dorsal and near the anterior end. Sipunculoids may be recognized by their ability to introvert the anterior extremity of the body. They are common on beaches but live inconspicuously in crevices in rocks, or burrowing in sand or mud. The body cavity contains corpuscles coloured by a red respiratory pigment, oxyhæmerythrin, which in the reduced form is colourless. The Sipunculoidea along with the Echiuroidea, now transferred to the Annelida, were placed in Haeckel's classification in a class, Gephyrea. The process of splitting up the "Vermes" into assemblages of forms based on Unity of Type is not as yet completed, that is to say, it is not one on which unanimity has been reached. If we exclude the Tunicata—about which more must be said later—the following represent a by no means exhaustive list of separate

phyla recognized by modern authors under Haeckel's *Vermes*: Annelida, Platyhelminthes, Nemertinea, Nemathelminthes, Rotifera, Brachiopoda, Polyzoa, Sipunculoidea, Phoronidea, Priapuloida, Chætognatha. But some of these terms (e.g. Polyzoa) may include forms which should be further separated.

Allies of the Vertebrates.—One class included in Haeckel's *Vermes* is a group which has had an erratic history in zoological classification, and like the barnacles, one whose present position in the animal kingdom is based more on its larval than upon its adult characteristics. The Tunicata or sea squirts were placed at one time among the Molluscs. This association has no justification in the light of what we know of either their adult or larval characters. Their present position in zoological classification, like that of the barnacles, illustrates the extension of the Principle of Unity of Type to the study of all stages in the development of an animal.

In Flat-worms, Nemathelminthes, Annelids, Molluscs, and Arthropods, there is one underlying feature of similarity in the general architecture of the body, especially in relation to the relative positions of the C.N.S. and gut, namely, the presence of a dorsal ganglion above the mouth and a pair of lateral nerve-cords, which tend to be approximated ventrally below the gut, forming a circumœsophageal ring in all except the flat-worms. In the Vertebrate phylum the C.N.S. is wholly dorsal to the gut and arises as a median tubular infolding of the ectoderm or outer skin of the embryo. This feature of organization together with certain minor points is shared by a few other forms. For this reason many authors have relegated the Vertebrata (or Craniata) to a sub-phylum of the phylum *Chordata*, which is distinguished by the above characteristics, and the presence of pharyngeal clefts and a notochord at some stages of develop-

ment. It is within this assemblage that the Tunicata are placed.

The Vertebrates, however, form a compact group, sharply distinguished in particular by (1) the head with its characteristic receptors, eye muscles, and cranial nerves; (2) the circulatory system. So this procedure does not seem more justifiable than placing the Arthropods and Annelids in one phylum. The groups that have been added for the construction of the phylum Chordata are: (1) the Cephalochorda; (2) the Urochorda or Tunicata; (3) the Hemichorda. Of these the first two are undoubtedly closely related to the stock from which Vertebrates arose. The affinities of the third are not so convincing. To avoid multiplication of phyla we shall consider these three groups under the phyletic heading *Prochordata*.

1. *Cephalochorda*.—The Cephalochorda are, of all the Prochordata, most like Vertebrates, and are represented by a single marine genus *Amphioxus*, whose distribution is world-wide. It was placed by Pallas (1788) in the Linnæan genus *Limax* among the slugs as *Limax lanceolatus*. It was lost to the zoological world again till 1834, when Costa renamed it *Branchiostoma* and recognized its affinities with the Fishes. Two years later Terrel (1836) redescribed it under its present name in *The History of British Fishes*. It appears as the sole representative of an order of fishes (*Pharyngobranchii*) in Huxley's classification, and as a separate class of Vertebrates in Haeckel's *Leptocardii*. In fact it is as distinct from the true Vertebrates or Craniata as are the sea squirts.

It is a fish-like form, burrowing in sand, and having a decided and not wholly superficial resemblance to the larval form of the lamprev. The myotomes or muscle segments are

like those of a fish, save that the segmentation extends to the anterior extremity. The spinal nerves have dorsal and ventral roots which do not unite. The Vertebrate sense organs, eye muscles, etc., are absent. The circulatory system without heart or red blood corpuscles is very poorly developed. The

Lateral view

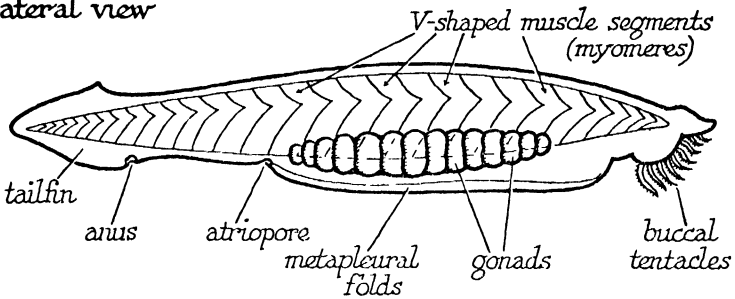

Longitudinal section

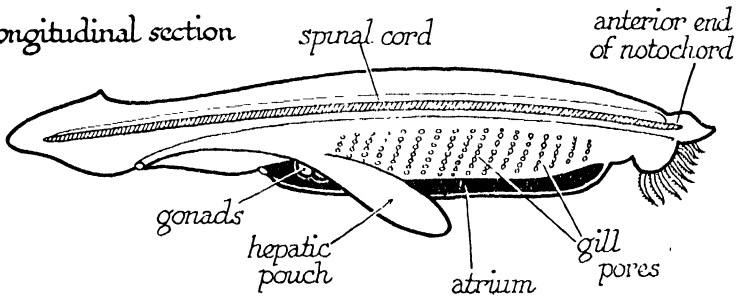

FIG. 122—AMPHIOXUS

notochord extends to the anterior extremity and is co-extensive with the whole length of the body. One peculiar feature of Amphioxus is the presence in the dorsal part of the body cavity in the pharyngeal region of a paired series of nephridia with flame cells, extraordinarily like those of Polychætes. The gut is straight and perforated for about half its length by fine pores, so that in this region of the pharynx its walls are like a sieve. The pores do not lead directly to the

exterior but into a cavity, the *atrium*, formed in development by the downgrowth of two flaps of the body wall which meet ventrally so as to constitute a closed chamber which communicates with the exterior by a mid-ventral aperture behind the pharyngeal region.

The entire internal wall of the pharynx and sides of the

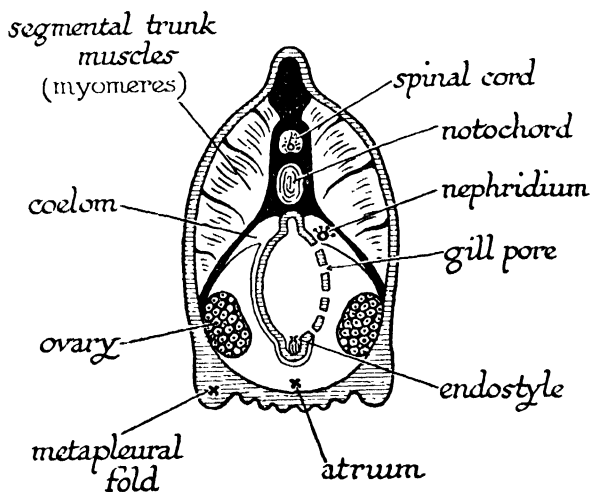

FIG. 123—AMPHIOXUS—TRANSVERSE SECTION THROUGH GILL REGION

pores are lined with ciliated epithelium, and the cilia are so arranged as to constitute a food-net very much like the gill of a clam in its operation. The lateral cilia which line the pores create a current from the mouth into the atrium. From a ventral groove or endostyle a sheet of mucus is thrown on to the sides of the pharynx by longitudinal rows of long cilia. The facial cilia which line the internal walls of the pharynx wash this sheet of slime with entangled food particles up to a dorsal groove whose cilia maintain a current backwards towards the intestine. An endostyle like that of *Amphioxus*

is present in the lamprey larva. It becomes separated off at metamorphosis to form the thyroid gland.

2. *Urochorda* (*Tunicata*).—The Urochorda or Tunicata (Fig. 124) are a more comprehensive group than the foregoing. Their association with Amphioxus dates from the researches of the Russian zoologist Kowalewsky (1866), who first elucidated the life history of the sea squirts and of Amphioxus. Tunicates agree in having a dorsal tubular C.N.S. at least at one stage in development, and an elongated well-defined notochord restricted to the tail region of the body which is of tadpole-like configuration in the larval stage. The characteristic Vertebrate sense organs are lacking in the tadpole larva, but the anterior end of the C.N.S. is enlarged to form a brain. In one group of Tunicates (Larvacea) the tadpole-like form of the body with its notochord and dorsal nerve is retained throughout life. In the largest group (Ascidiacea) the larva attaches itself at the time of metamorphosis to some surface by the head region (cf. the barnacles); the tail and notochord are absorbed; and the C.N.S. persists as a ganglion between the mouth and anus, which has shifted through 180°. The whole body is enveloped in a thick cellulose case or test. The only trace of chordate characteristics that the adult retains is the sieve-like pharynx surrounded by an atrial cavity. This structure with its endostyle is remarkably like that of Amphioxus, constituting a ciliary feeding mechanism. Some forms are solitary, others by budding give rise to colonies of individuals embedded in a common test and sometimes connected with one another by a stolon. The beautiful luminescent *Pyrosoma* forms cylindrical pelagic colonies. In a third group (Thaliacea), including two pelagic forms, *Salpa* and *Doliolum*, which are widely distributed,

the adult form is essentially very much like a simple Ascidian, but it is not sedentary. These forms have a regular alternation of sexual and asexual generations, the sexual individuals being formed as small buds from a ventral appendage known as the stolon. Both simple and colonial

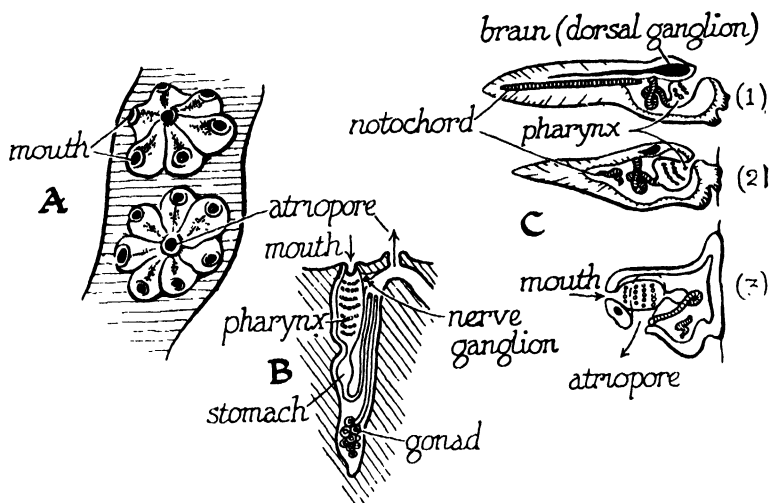

FIG. 124—TUNICATA

(A) Colonies of a sea squirt attached to a piece of weed; (B) Longitudinal section through single zooid of a colony; (C) (1) The tadpole-like larva undergoing metamorphosis (2)-(3).

Ascidians are common between tide-marks on rocky shores. The simple Ascidians (sea squirts, red-bair, etc.) are unmistakable objects. The colonial Ascidians are easily mistaken for sponges.

3. *Hemichorda*.—The Hemichorda are of much more doubtful position than the foregoing and include two groups. The Enteropneusta are typified by the burrowing marine acorn-worm, *Balanoglossus*. The acorn-worms, distinguished by the conical proboscis in front of the mouth,

followed by a thickening of the integument known as the collar, are placed near Amphioxus and the Tunicates, chiefly on account of the structure of the pharynx, which is perforated in a manner extraordinarily similar to that of Amphioxus. It communicates with an atrial cavity that is, however, dorsally and not ventrally placed. A diverticulum from the gut extending into the proboscis region has been compared to the notochord. The C.N.S. is represented by dorsal and ventral cords lying immediately under the epidermis. The acorn-worms have a free-swimming ciliated larva which strikingly resembles that of the sea cucumbers. Placed near the Enteropneusta is a group of colonial organisms (Pterobranchia) superficially like Polyzoa. The zooids have the body divided into a proboscis, collar, and trunk like the acorn-worms. These have pharyngeal clefts and a structure resembling the supposed notochord of Balanoglossus. From the collar region a ring of fine tentacles protrudes. The *chordate* characteristics of the Hemichorda were first emphasized by Bateson (1884-6), whose views have been very widely but not universally accepted by systematic zoologists.

TOPICS FOR HOME STUDY

1. Discuss the affinities of the Prochordata.
2. What are the structural peculiarities of:
 - (a) Coelenterates.
 - (b) Platyhelminthes.
 - (c) Annelids.
3. Justify the grouping of the apparently diverse Molluscan types in one phylum.
4. Illustrate the Principle of Unity of Type by reference to invertebrates.

CHAPTER XII

THE PRINCIPLE OF SUCCESSION WITH SPECIAL REFERENCE TO THE VERTEBRATE SKELETON

WE have now to turn to a third step in the Evolutionary argument. This is called the Principle of Geological Succession. From ancient times, but more especially from the end of the seventeenth century onwards, the hard remains of animals were unearched from time to time. For instance, shells of molluscs which only live in water were found far inland remote from lake, river, or sea. Such relics were attributed by the current mythology of Christian countries to the deluge that destroyed the contemporaries of the Noah family, and sceptics like Voltaire, who ventured to offer more naturalistic suggestions, were hardly more happy in their speculations. An exception must be made in favour of Xenophanes (*circa* 500 B.C.), and of the Arab physician Avicenna (*circa* A.D. 900), who recognized fossils as remains of animals formerly alive, and saw in them evidence of the existence of oceans where there is now only land. A giant fossil salamander which occurs abundantly in the Upper Miocene of Switzerland, closely related to the Japanese salamander *Cryptobranchus japonicus*, was unearched by Scheuchzer in 1726, and named *Homo diluvii testis*. The motto attached to his figure reads:

Betrübtes Beingerüst von einem alten Sünder
Erweiche Herz und Sinn der neuen Bosheitskinder.

Which is translated (*Camb. Nat. History*, viii, p. 84):

Oh, sad remains of bone, frame of poor Man of Sin,
Soften the heart and mind of recent sinful kin.

Not less grotesque is a legend, recounted by Cole, about the large fossil Foraminifer, *Nummulites*, which is found in limestones across Europe and Northern Africa into India. The medieval botanist Clusius (*circa* 1550) says that during the retreat of the Tartars before the Teuton soldiers coins were freely scattered with the object of diverting pursuit. The manœuvre was not successful; because the coins were con-

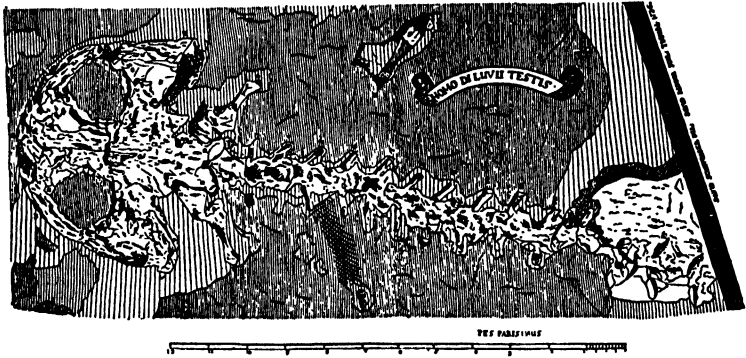

FIG. 125—THE REMAINS OF A GIANT SALAMANDER UNEARTHED IN 1726 BY SCHEUCHZER OF ZÜRICH. IT IS DESCRIBED IN HIS MONOGRAPH AS “HOMO DILUVII TESTIS” (MAN; WITNESS TO THE DELUGE)

verted into stones, i.e. *Nummulites*, by the intervention of “an obliging and sympathetic Deity.”

In modern times priority for the recognition of fossils as remains of what were once living animals is due to Steno (1699), a Danish anatomist who taught at Padua. In the early years of the nineteenth century Cuvier’s monograph on fossil remains initiated an epoch of systematic palæontology. The full effect of the researches of Cuvier’s school was not felt till the Uniformitarian doctrine, i.e. the view that successive strata have been deposited by a continuous process, had been established. This was chiefly due to the work of Lyell

(1830). The impiety of this new Geology did not escape challenge. In the minutes of a meeting of the Geological

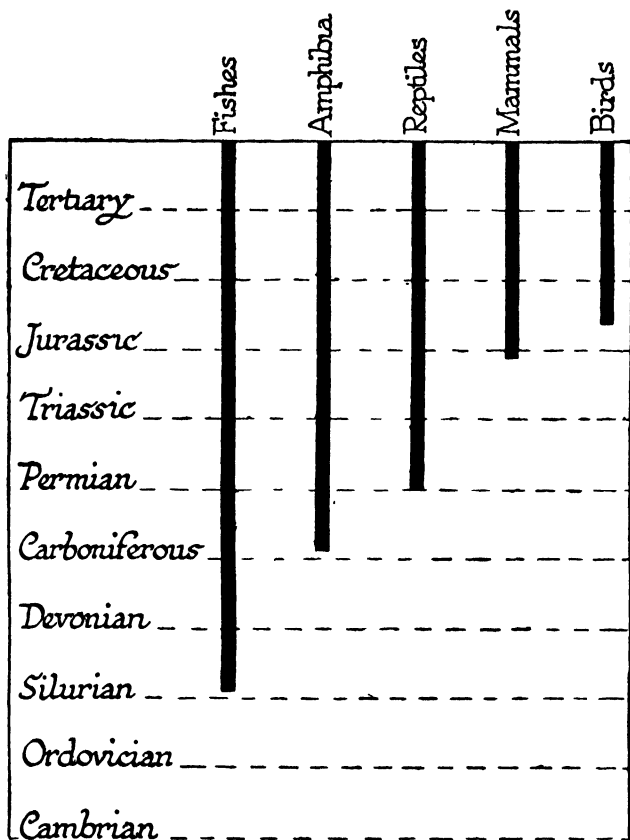

FIG. 126—THE SUCCESSION OF VERTEBRATES

Society of London in 1840, we read that the retiring president, Dr. Buckland,

with a look and tone of triumph pronounced upon his opponents who dared to question the orthodoxy of the scratches and grooves of the glacial mountains the pains of eternal itch without the privilege of scratching (*Hist. of Geol. Soc. of Lond.*, p. 142).

In what follows we shall assume the view which is now universally accepted. The various strata of which the earth's crust is composed have been laid down in orderly succession during periods of time compared with which that occupied by the history of human society is of negligible duration. Once this conclusion was accepted the study of fossils acquired a new interest and progressed rapidly under the leadership of men like Owen, Cope, and their contemporaries. Students of fossils set themselves to compare the characteristics of animals in different geological epochs, and to elucidate evidences of a continuous succession of new forms of life handed down to posterity in the record of the rocks. Out of their studies the Principle of Succession took shape.

The Principle of Succession may be stated in two ways. One is that many of the more highly specialized and successful groups of the present day did not exist at earlier periods of the earth's history, and were preceded by forms which are intermediate between them and representatives of surviving groups that already existed before them. Another is that the earliest members of the great groups usually exhibit a more generalized type of structure than existing types. Adequate material for drawing these conclusions is provided only by forms which had resistant structures such as the Vertebrates, Arthropods, and Vascular plants.

The earliest dominant group of Arthropods were the Trilobites (Fig. 128) which appear in the *lower* Cambrian. A few Crustacean types are found in *mid*-Cambrian rocks. The earliest Arachnida are marine types of which some resemble the king crab *Limulus*. The dominant Silurian Arachnid group was the *Eurypterida*, which were structurally intermediate between *Limulus* and land scorpions. Typical *land*

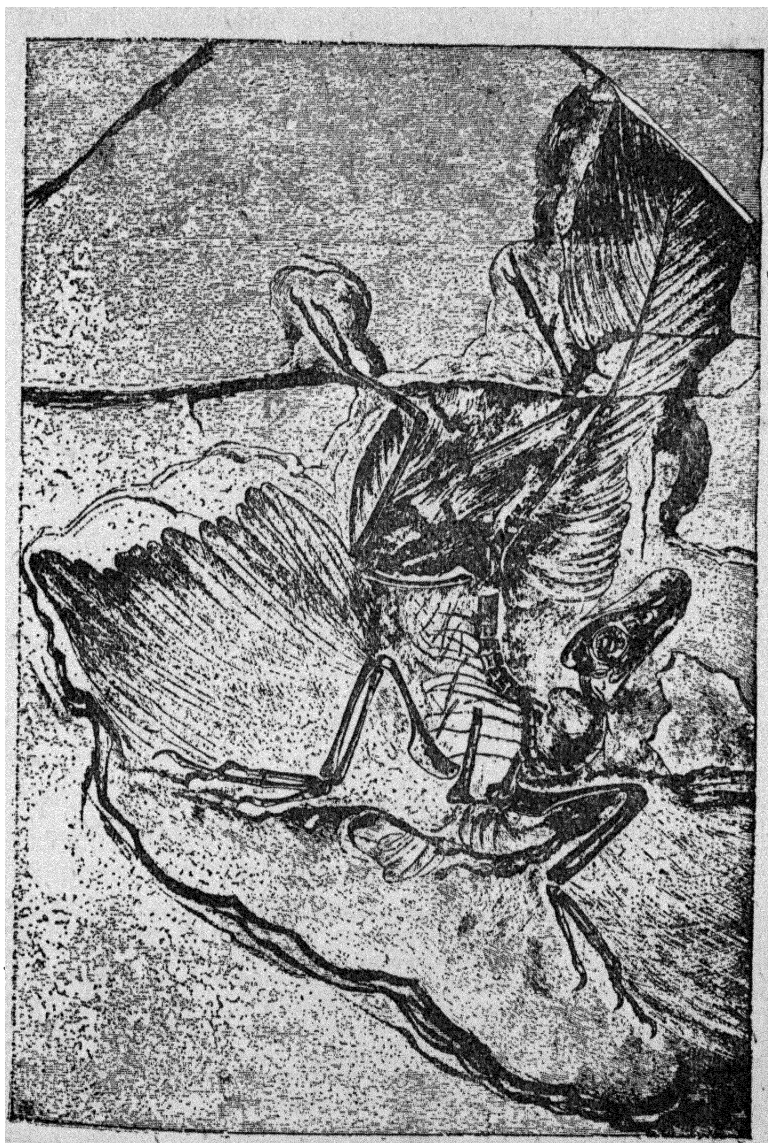

FIG. 127—REMAINS OF ARCHÆOPTERYX PRESERVED IN SHALE FROM SOLENHOVEN, BAVARIA

Arthropods, i.e. insects and spiders, appear in the coal measures. Land scorpions which are more generalized than

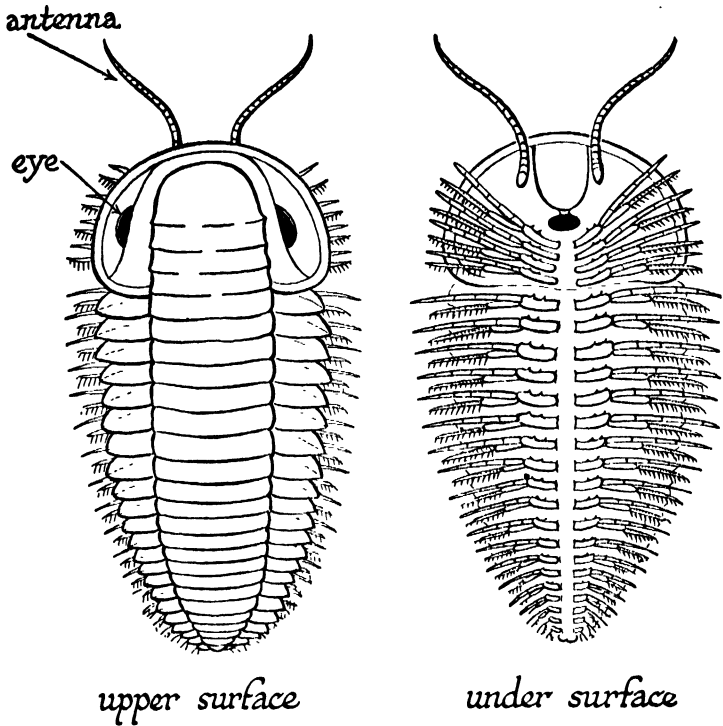

FIG. 128—TRILOBITE

The earliest representatives of the phylum Arthropoda found in the oldest sedimentary rocks are the Trilobites, a group which partake of the characteristics of all the more specialized classes which evolved later. Thus they have a single pair of feelers like insects, bifid swimming limbs like crustacea, and no specialized mandibles or biting jaws such as are present in insects and crustacea but absent in the arachnids. The Principle of Succession is well illustrated in Trilobites, owing to the fact that all parts of the body are enclosed in a hard case which readily leaves its impression on the sediment where it lies or becomes fossilized.

spiders and other land Arachnids had already turned up in the preceding epoch. If the Principle of Succession is true we

should expect that Trilobites are Arthropods of a more generalized type than members of any existing classes. Whether this is so can best be seen by asking what characteristics a generalized Arthropod would have.

In modern Arthropods at least *five* anterior segments are fused to form a head. The head of many Crustacea, of the marine Arachnid *Limulus*, of most insects, and of the centipede *Scutigera* bears a pair of compound eyes. Behind the head the succeeding segments may be differentiated in various ways in different types. In Myriapods they are similar and this is true of some Crustacea. The abdominal appendages of *Limulus* and the mouth parts of insects and Myriapods are *biramous* structures and this is the general characteristic of Crustacean Swimmerets. Myriapods, Insects, and Crustacea have at least *one* pair of antenniform appendages in front of the mouth. The biting mandibles of insects correspond to the basal portion of a limb, which retains a vestigial axis in millipedes and in many Crustacea. In Arachnids several appendages behind the mouth have biting bases (gnathites), and no one is completely subordinated to a masticatory function. We may therefore reconstruct a generalized Arthropod type with a head composed of five segments with a pair of feelers and compound eyes, succeeded by a number of similar segments bearing biramous appendages with gnathites. This in fact is a precise specification of the characteristic features of the now *extinct* Trilobita.

Fossil remains of the skeletons of Vertebrates provide one specimen which illustrates the Principle without recourse to specialized knowledge. *Archæopteryx*, the first undoubted bird which is beautifully preserved in the Bavarian lithographic limestone, has many striking reptilian features (Fig. 127). The forelimb has three complete clawed digits

with the normal number of phalanges. There was a long tail like that of a lizard. Unlike that of any modern bird the skull had teeth and distinct sutures. A covering of feathers and the tarso-metatarsus (Fig. 127) of the hind limb leaves no doubt about the fact that Archæopteryx was essentially a bird.

For further evidence we have to rely on detailed study of

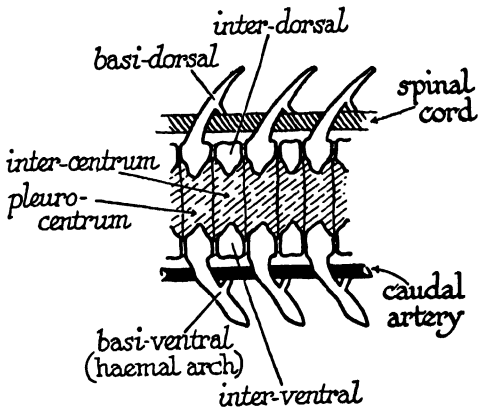

FIG. 129—TAIL VERTEBRÆ OF THE GANOID FISH (*Amia*)

Basidorsal = Neural Arch

the skeleton. It will first be necessary to draw attention to certain aspects of the classification of living and fossil types. The subject matter of this chapter should be supplemented by a comparative study of the skeletons of the frog, man, the fowl, the crocodile or tortoise, and the dogfish in the laboratory; demonstrations of the scaly armour of the sturgeon or bony pike, and visits to a museum where specimens of fossil Vertebrates are exhibited.

Modern fishes fall into three main groups. The *Elasmo-branchs* (sharks, skates, dogfishes) have tooth-like scales (denticles) which, like our own teeth, are composed of a hard

tissue called *dentine* overlaid by *enamel*. The endo-skeleton is entirely cartilaginous. They have no *operculum* nor swim bladder. The *Teleostei* or true bony fishes are a second group with the largest number of species. They appear late in the

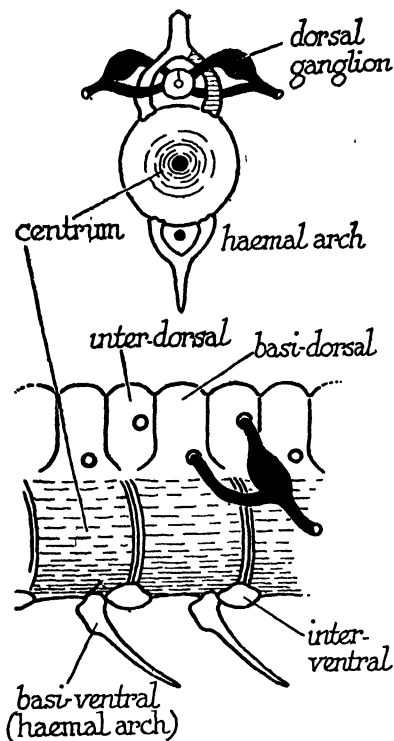

FIG. 130—VERTEBRÆ OF AN ELASMOBRANCH (ACANTHIAS)

Jurassic epoch. The scales are thin plates of bone without dentine or enamel. The endo-skeleton is bony. They have an *operculum*, or gill-cover, and a swim bladder. They have no spiracle. The so-called *Ganoid* fishes are a miscellany of survivors from very ancient stocks. Their scales are of true bone overlaid with dentine and enamel. They have spiracles, a

swim-bladder which may be double, and an operculum. The sturgeons (*Chondrostei*), with three living genera, are most like the sharks. The swim-bladder of sturgeons, like that of *Teleostei*, is not a respiratory organ. That of the other *Ganoids*

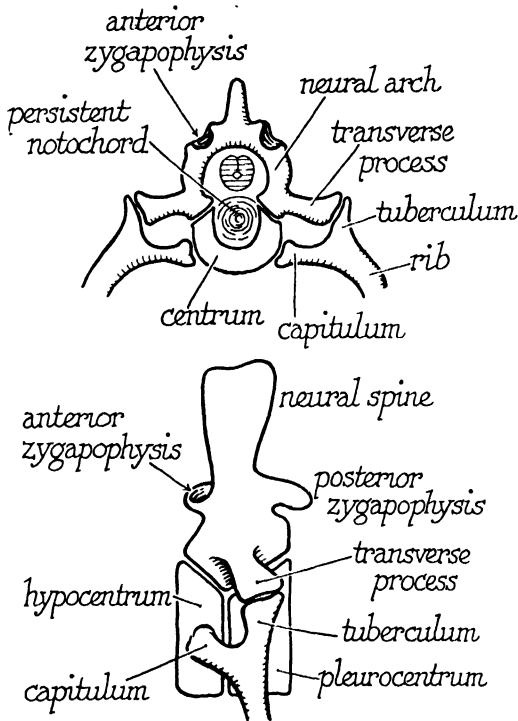

FIG. 131.—TRUNK VERTEBRA OF A STEGOCEPHALIAN

is a lung supplied from the last branchial artery. In one group, the Lung fishes (*Dipnoi*), made up of three living genera, the atrium is completely divided into right and left auricles, of which the left one receives the pulmonary vein (Fig. 55, p. 144). They have a true postcaval vein (Fig. 60, p. 150). Thus their circulatory arrangements are essentially similar to those of salamanders. The remaining *Ganoids* are placed in four

orders (Polypterini, Amioidei, Lepidostei, Cœlocanthini), of which each except the first is made up of a single living genus.

When extensive land floras were making their appearance towards the end of the Devonian, remains of the first land Vertebrates (*Stegocephali*) turn up. The first land Vertebrates of the late Devonian and early Carboniferous were creatures like salamanders with short legs. True birds and mammals appear in the Jurassic. During the Silurian epoch several types of true fishes (i.e. aquatic Vertebrates with paired fins and jaws in contra-distinction to Cyclostomes) make their appearance. The four principal types are:

(a) *Acanthodei*, a group of forms which have left no survivors. The shape of the body was somewhat like that of sharks. The spiracle was not essentially different from the succeeding branchial clefts. The scales were like the Ganoid type found in sturgeons and lung fishes, i.e. they had a layer of true bone covered with dentine and enamel. The anterior margin of the paired and dorsal fins was supported by a powerful spine.

(b) *Osteolepidi* and the closely related *Cœlacanthini* which have left a single living representative of which one specimen, *Latimeria*, was recently dredged (1939) off the coast of Natal.

(c) *Protoselachii*, i.e. sharks with certain primitive features referred to below.

(d) *Actinopterygii*, Ganoid fishes of a type not far removed from the sturgeons.

To see how the emergence of new Vertebrate types illustrates the Principle of Geological Succession we must now examine the characteristics of the different parts of the skeleton.

(i) *The Axial Skeleton*.—In a land Vertebrate each vertebra consists of the following parts (Fig. 131). Over the spinal cord is the neural arch with its characteristic articular surfaces (*zygapophyses*) interlocking with those of the succeeding or preceding vertebra. The posterior pair overlap the anterior pair of the next vertebra behind. So the front face of a vertebra can be recognized by the fact that the articular surface of the zygapophysis faces upwards. On either side of the base of the neural arch are the *transverse processes* with which the ribs articulate by their *tubercular* extremities. The ribs of modern Amphibia are cartilaginous vestiges with a single head. Among birds, mammals, and some reptiles the rib has a second or *capitular* head which rests against the body or *centrum* of the vertebra. The latter is built up round the notochord of the embryo, and completely replaces it in adult life as the supporting axis of the trunk. In some salamanders, and in the New Zealand lizard *Sphenodon*, both articular faces of the centrum are concave (*amphicœlous* type) and the remains of the notochord persist between them. Most other Amphibia and Reptiles have centra which fit tightly by a ball and socket joint. Usually the anterior face is concave and the posterior convex (*procœlous* type). Mammals have centra with flat faces. Modern birds have centra of which each articular surface is saddle-shaped (*heterocœlous* type).

At the opposite end of the Vertebrate series the axial skeleton of Cyclostomes is represented only by the persistent unstricted notochord and by V-shaped cartilaginous neural arches which lie over the spinal cord. Between this state of affairs and the solid type vertebra characteristic of land Vertebrates, true fishes provide examples of various grades. In some of the Ganoids (sturgeons and lung fishes)

the unconstricted notochord is enclosed in a fibrous sheath above which lie cartilaginous or bony dorsal elements

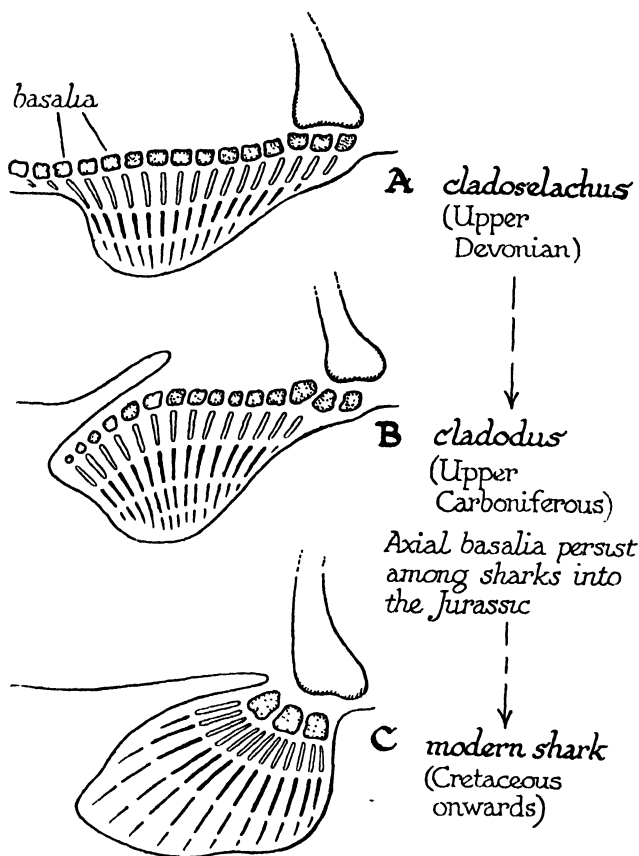

FIG. 132—FINS OF SELACHIANS

(neural arches). Below are analogous basal elements (*haemal* arches) which enclose the caudal artery in the tail region, and diverge widely as *ribs*, or as transverse processes to which ribs are attached, in the region of the trunk. These fishes have nothing which corresponds to the centrum of the

land Vertebrate. The vertebræ of Teleostei and of Elasmobranchs are composite (Fig. 130). They have centra of the amphicæulous type found among salamanders and in the New Zealand lizard *Sphenodon*. In Elasmobranchs each vertebra has a complete neural arch which is *obliquely* placed above the centrum and occupies about half the overlying space in *front* or *behind*. Behind successive arches are *interdorsal* plates which fill up the gap over the spinal cord. Small *inter-ventral* plates below the centrum may also alternate with hæmal arches. In the tail region of the Ganoid *Amia* each vertebra is made up of a pair of centra, a pair of dorsal (neural), and a pair of ventral (hæmal) elements (Fig. 129).

The salient points which emerge from this survey of the axial skeleton of living Vertebrates are: (*a*) that in general the vertebræ of fishes exhibit a structural *duplicity* which is not found among any living land Vertebrates; and (*b*) that since it is also common among fishes, the amphicæulous vertebra is a more generalized type than others found among living land Vertebrates. If then the Principle of Succession is supported by the evidence derived from the peculiarities of the axial skeleton in fossil types, two conclusions follow: (*a*) the earliest land Vertebrates should have double vertebræ; and (*b*) the earliest representatives of the land Vertebrate groups should have amphicæulous vertebræ. Both these statements are true. The Stegocephali have vertebræ which are very different from those of living land Vertebrates. They have double centra (Fig. 131). All the earliest land Vertebrates, including the first fossil birds, had amphicæulous centra.

(ii) *The Limb Skeleton*.—From the standpoint of limb specialization Vertebrates fall into three grades: (*a*) Cyclostomes, which are limbless and have no structural charac-

teristics which suggest that they ever had limbs; (b) Fishes, which have paddle-like limbs supported by numerous

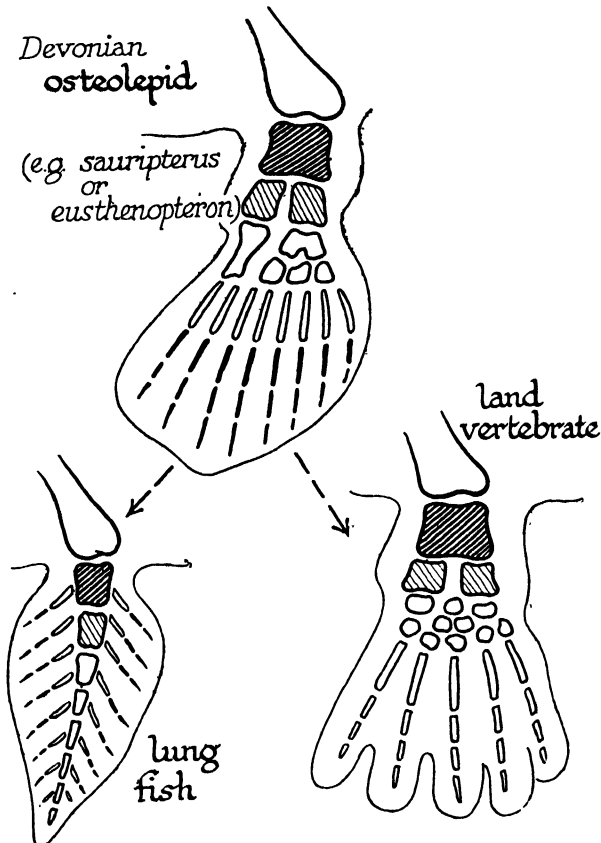

FIG. 133—RELATION OF FINS TO THE PENTADACTYL LIMB

filamentous bones (or cartilages) called *fin rays*; (c) *Tetrapoda*, i.e. "land" Vertebrates, of which both limbs consist of a jointed axis ending typically in five fingers (or toes). Since fishes were preceded by an extinct group (*Ostracodermi*) which were limbless like lampreys, and since land Vertebrates

did not appear till fishes had come into being, the record of the rocks raises two problems from the present standpoint. One is whether we find among the earliest fishes intermediate types which bridge the gulf between modern fishes and limbless types. The other is whether we find among the earliest fishes and land Vertebrates intermediate types which bridge the gulf between the paddle-like fin and the axiate five-fingered leg.

The first question raises a difficulty at the outset, unless we are able to form a likely view of what such an intermediate type would be like. Two facts about the structure of fishes had suggested a hypothesis which has since been supported by the discovery of fossil types. One is that the skeletal and integumentary structure of the paired fins with their fin rays is remarkably like that of the dorsal fin and the ventral fin of the caudal region. Either of these may be continuous or broken up into discrete portions. This suggests the possible existence of a more generalized fish type in which a lateral fin extended on either side along the trunk region. The other fact which lends colour to this suggestion is an essential difference between the organization of a fish and that of *Amphioxus* or of the lamprey. In the caudal region of fishes separate muscle bands (*Myotomes* or *Myomeres*) ensheathed in fibrous tissue correspond to each pair of spinal nerves and to each vertebra. The structure of the trunk region is not segmental. Several pairs of spinal nerves fuse to form the main nerves of the legs of a Tetrapod, and a regular succession of muscle bands corresponding to each pair of nerves in the fish embryo cannot be distinguished in the region anterior to the tail. To bridge the gap between fishes and fish-like animals in which a regular arrangement of nerve and muscle segments continues in front of the tail region,

we are therefore tempted to look for an animal in which the base of the fin extended lengthwise in both directions along the trunk.

In the fins of modern fishes the thin fin rays are generally attached to the limb girdle enclosed in the trunk itself by a single row of stouter *basal* elements. This is true of all fishes

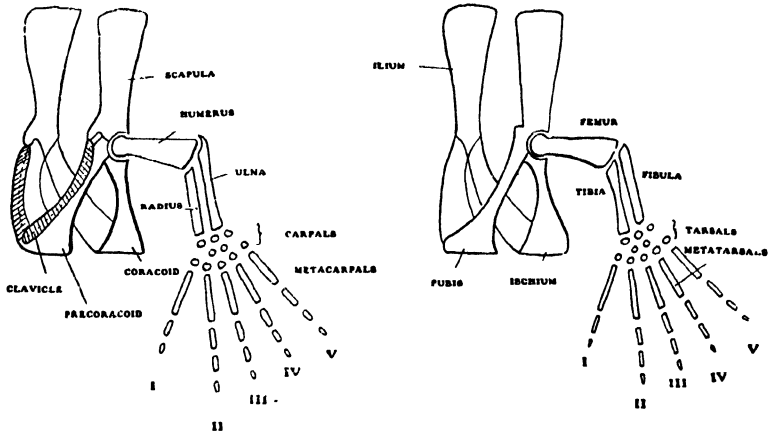

FIG. 134—THE PENTADACTYL LIMB AND ITS GIRDL

Left, Fore limb. *Right*, Hind limb. The head end of the animal is towards the left.

except the Dipnoi, in which they are attached to a central axis (Fig. 133). Although a fossil with a continuous lateral fin in the trunk region has not yet been found, peculiarities of some of the earliest fishes conform to this picture in a very remarkable way. Both in the earliest sharks (e.g. *Cladose-lachus*, Fig. 132) and in the extinct Acanthodei the base of the fin is very broad, and in one species of the latter group (*Climatius*) a row of lateral spines like the spines which support the anterior margin of the paired and median fins occupies the gap between the pectoral and the pelvic bones.

Before we can discuss the existence of fossil types which

bridge the gap between the fish fin and the pentadactyl limb of land Vertebrates, we must first study the general characteristics of the latter. The typical pentadactyl limb has characteristics common to both the fore and hind member. The names used are indicated in Fig. 134. The limb girdle consists of three paired elements, one which is dorsal (*scapula* or *ilium*) corresponds to the main part of the fore-limb girdle of a fish. The other two are ventral, an anterior

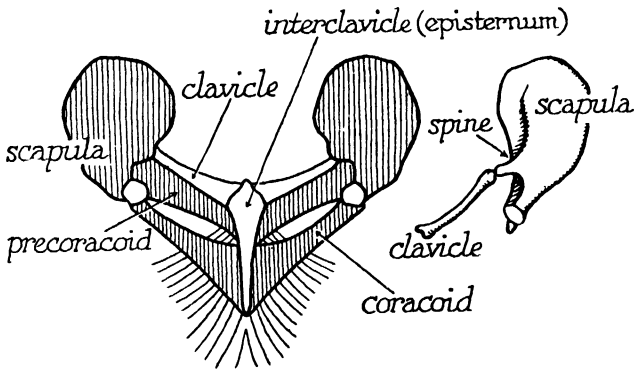

FIG. 135—SHOULDER GIRDLE OF A MONOTREME (left) AND TYPICAL MAMMAL (right)

pair (*precoracoids* or *pubes*) and a posterior pair (*coracoids* or *ischia*). All three elements are always present in the posterior or pelvic limb girdle of a land Vertebrate. They are generally present in the pectoral girdle of Amphibia and of lizards. In crocodiles and birds only one ventral element is present, and it is not certain whether it corresponds to the precoracoid or the coracoid of lizards. With the exceptions mentioned below the adult mammalian shoulder girdle has no separate precoracoids or coracoids. A vestigial coracoid may be fused with the articular facet of the scapula, which has a characteristic median ridge, called the scapular spine.

The preceding remarks do not apply to the shoulder girdle of two mammals *Platypus* and *Echidna* placed in the order called *Monotremata*. Monotremes, like lizards, lay eggs with calcareous shells, and the monotreme shoulder girdle is of the generalized lizard type. It has precoracoids and coracoids which meet the breast bone (*sternum*) and a T-shaped

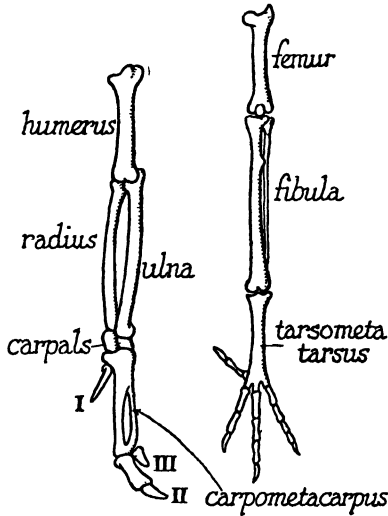

FIG. 136—LIMB SKELETON OF A BIRD

median bone called the *interclavicle*, also characteristic of lizards. Nearly all land Vertebrates have a ventral pectoral bone (*clavicle*) which is not pre-formed in cartilage like the bones of the axial skeleton and the other bones in the limb skeleton shown in Fig. 134. A similar bone is present in the pectoral girdle of Ganoids and Teleosts.

The main axis of both the fore and hind limbs is essentially similar in nearly all living land Vertebrates in so far as it consists of a proximal portion with a single shaft bone (*humerus* or *femur*) and a distal portion of two parallel bones

(*radius* and *ulna*, or *tibia* and *fibula*). To the distal end of the latter are attached the wrist (*carpal*) or ankle (*tarsal*) bones, which are never more than ten in number. From these radiate typically five (never more) *metacarpals* or *metatarsals* with the *phalanges* at their extremities arranged in series like fin rays. The last remark implies that the main axis of the limb is what is most distinctive of the Tetrapod. The Principle of Succession therefore implies that we should

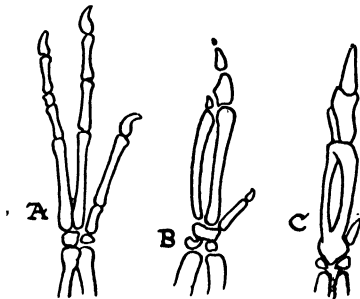

FIG. 137—DIGITS OF FORE LIMB OF ARCHÆOPTERYX (A); SIXTEEN-DAY CHICK (B); ADULT FOWL (C)

expect to find among the earliest fishes species of which the fin rays diverged from the end of an axis attached to the limb girdle.

In modern fishes the fin rays usually diverge from the ends of a row of parallel short and stouter basal elements. There are two exceptions to this rule. The fins of lung fishes have a central bony axis, and the fins of the *Polypterini* (p. 133) which can also breathe air, have a solid fleshy pad between the trunk and the fin itself. As already mentioned, the earliest Ganoids of the Devonian fall into two main groups. One type have fins like those of sturgeons and of bony fishes with numerous short parallel *basals* and no fleshy axis. In contradistinction to this *Actinopterygian* type, the Osteo-

lepid fishes of the same epoch had a fleshy axis which tapers along the mid-line of the fin. A series of fossil species link this type of fin with the Dipnoi, which are more like land Vertebrates than are any other living fishes.

It is therefore among Osteolepids that we should look for the missing link with the Tetrapods. The bones of the axis of the fins of some Osteolepids are beautifully preserved, and in two genera (*Sauripterus* and *Eusthenopteron*) the first two rows of the axis consist respectively of a single and of a pair of parallel elements (Fig. 133). Bones which might be compared with the carpal or tarsal series exceed in number the maximum (ten) in the limb of any living land Vertebrate. Among the Stegocephali and earliest reptilian types are several genera in which the carpal and tarsal bones are more numerous, and a more detailed comparison can be drawn between their limbs and those of Osteolepid types.

Within land Vertebrates as a whole the outstanding specialization of limb structures is found among birds. The hand has vestiges of three fingers and no trace of the other two. The hind limb is even more peculiar. There are no separate tarsal bones. The proximal ones are fused with the distal end of the tibia, and the distal ones are fused with the metatarsals in a single shaft bone, the tarso-metatarsus. Associated with the bipedal carriage of birds is a peculiarity of the hind limb girdle. The junction (*sacrum*) of the ilium with the vertebral column is greatly extended, so that the ilium which is typically boat-shaped is attached before and behind the thigh joint (*acetabulum*). Both pubes and ischia are slender.

The first authentic bird, i.e. feathered Vertebrate, which is known to us is of the Jurassic genus called *Archæopteryx*. *Archæopteryx* had three long fingers with claws and toes

attached to a typically Avine tarso-metatarsus. The Record of the Rocks reveals the existence of a class of bipedal reptiles called *Dinosaurs*. Living side by side with Archæopteryx these reptiles attained enormous dimensions in the Cretaceous and then died out. The manus of several Dinosaurs is tridactyl like that of Archæopteryx. The boat-shaped ilium and the slender pubes and ischia of Dinosaurs are essentially Avine. The limbs of many of the earlier

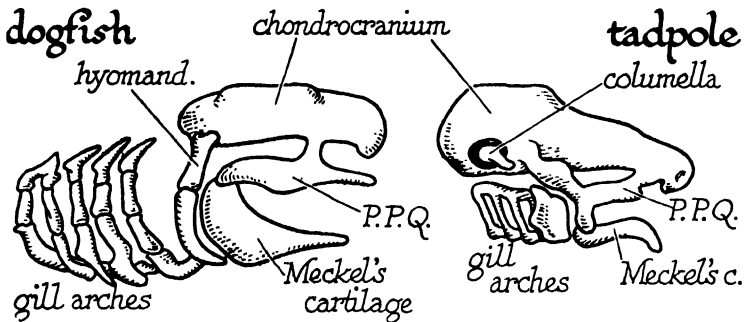

FIG. 138—CARTILAGINOUS SKULLS OF THE DOGFISH (left) AND THE FROG TADPOLE (right)

P.P.Q. is the quadrate or palato-pterygo quadrate bar.

Dinosaurs were hollow like those of birds, and metatarsals of some genera (e.g. *Ceratosaurus*) are greatly elongated and closely opposed though not actually fused. As far as the limb skeleton is concerned, we can therefore say that the first birds were more like other land Vertebrates than are any modern ones, and that they lived at the same time as reptiles which were much more like birds than are any reptiles living to-day.

(iii) *The Head Skeleton.*—Excluding Cyclostomes we can distinguish three main types of head skeleton. In the shark type it is entirely composed of cartilage. The scales of the

skin do not contribute to it except in so far as the jaws are fringed with thick-set *denticles*. It consists of the following parts: (a) a brain-box or *chondrocranium*; (b) the upper (*quadrate bar*) and lower (*Meckel's cartilage*) jaws; (c) *visceral arches* of serial cartilages behind the spiracles and gill clefts.

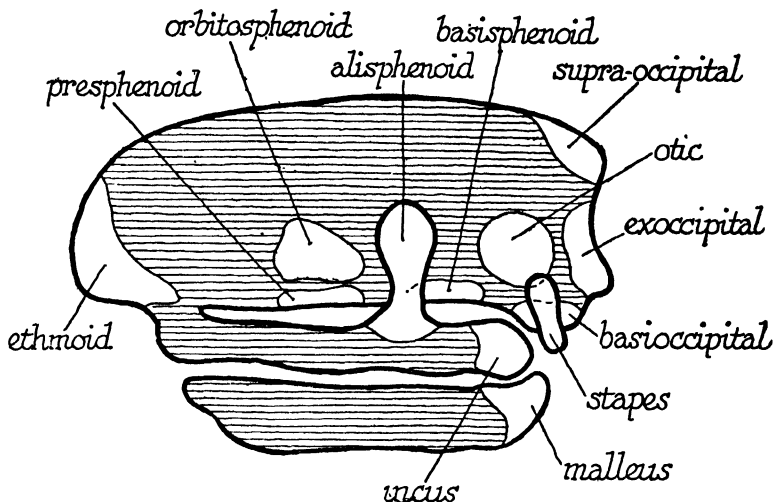

IG. 139—THE CHONDRIAL BONES OF THE MAMMALIAN SKULL

(1) Otic; (2) Basisphenoid; (3) Presphenoid; (4) Ethmoid; (5) Orbitosphenoid; (6) Alisphenoid (= epipterygoid); (7) Exoccipital; (8) Supra-occipital; (9) Incus (= Quadrate); (10) Malleus (= Articular); (11) Basioccipital; (12) Stapes (= hyomandibular or columella auris).

The head skeleton of a tadpole is of the same type, and vertebrate embryos in general pass through an initial stage which is essentially similar. In the Ganoid type the cartilaginous constituents mentioned already are generally converted into true bone in the course of development. The chondrocranium does not ossify as one piece. The entire head region including the inner and outer surface of the lower jaw, the operculum and the roof of the mouth, is

invested with a helmet of large scales more or less indistinguishable from the scales of the trunk region. The scaly plates of this helmet do not overlap like the latter. They are firmly united at their edges. The type of skull common to living land Vertebrates and to the bony fishes is a *composite* structure formed partly of elements which are preformed in

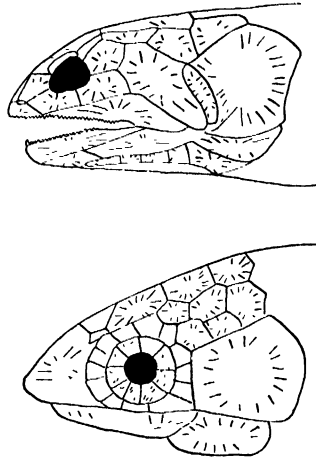

FIGS. 140—HEADS OF TWO FOSSIL FISHES FROM THE DEVONIAN ROCKS.
ABOVE: OSTEOLEPIS. BELOW: DIPTERUS

cartilage like the corresponding constituents of the internal skull of Ganoids, and partly by bones which are not formed out of the cartilaginous skull of the embryo. Though these bones are of more superficial origin they come to lie below the skin and are firmly united with the foregoing.

In the third group we can again distinguish three main types. In Teleostei the posterior end of the jaw is united to the proximal part of the first (*hyomandibular*) visceral arch, and there is a bony *operculum*. In land Vertebrates generally there is no operculum, and except among aquatic

Amphibia the visceral arches are greatly reduced, remaining as supporting rods for the muscles of tongue and larynx. In land Vertebrates other than mammals the hyomandibular corresponds to the single ear ossicle which lies between the tympanum and the internal ear; the articular ends of the upper and lower jaw are two bones respectively formed from Meckel's cartilage (the articular) and the *quadrate* bar. The

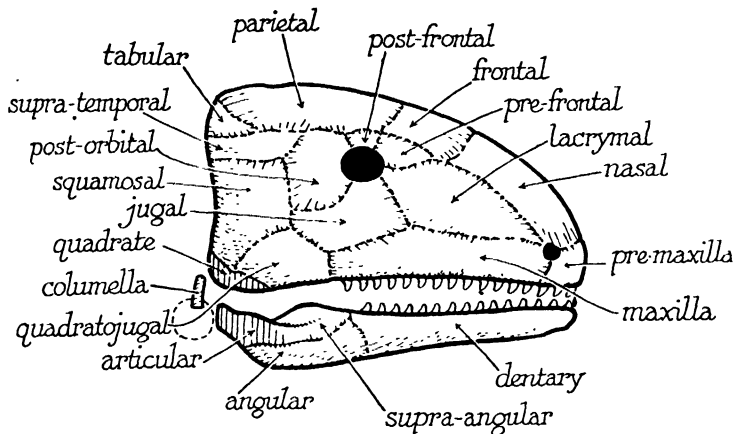

FIG. 141—THE SKULL OF A PRIMITIVE AMPHIBIAN (STEGOCEPHALIAN) OR REPTILE (COTYLOSAUR) FROM THE PERMIAN OR CARBONIFEROUS BEDS (Diagrammatic)

lower jaw is always composed of several discrete bones. Mammals have three ear ossicles. The lower jaw is a single bone which is not preformed in cartilage.

With reference to the head skeleton two outstanding questions which arise in connexion with the Principle of Succession are therefore: (a) whether the skulls of early land Vertebrates are intermediate between the Ganoid type and the composite type characteristic of living Tetrapods; (b) whether we find among reptiles living side by side with the first mammals types whose skulls are intermediate

between the characteristic mammalian and the more generalized land Vertebrate pattern.

In the earliest Ganoid fishes the scaly plates of the head were, as in the sturgeons to-day, very numerous, especially around the orbit. In such a form as *Osteolepis* the number of investing bones was with minor exceptions reduced to the

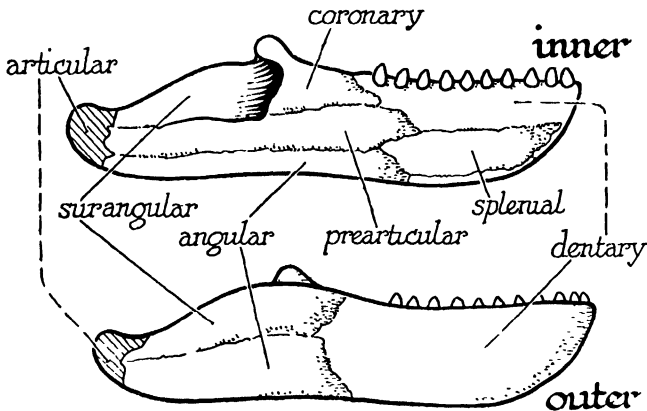

FIG. 142—THE COMPOUND LOWER JAW OF A REPTILE

Inner aspect above, outer below.

- (1) Dentary; (2) Splenial; (3) Prearticular; (4) Coronary; (5) Angular; (6) Surangular; (7) Articular.

fixed number found in the earliest Carboniferous Amphibia (*Stegocephali*) and earliest Permian reptiles (*Cotylosauria*). In the earliest land Vertebrates these investing bones were still superficial and quite separate from the bony internal skull. Moreover, they displayed the characteristic sculpture of the dermal armour of the head still seen in surviving freshwater Ganoids like the bony pike (*Lepidosteus*).

These bones (Figs. 141, 144) were as follows: (a) on the roof, paired *tabulars*, *parietals*, *frontals*, *nasals*; (b) fringing the upper jaw of either side, *quadratojuggals*, *maxillæ* bearing

teeth and *premaxillæ* also bearing teeth; (c) around the orbit *postfrontals*, *postorbitals*, *jugals*, *lacrymals*, and *pre-frontals*; (d) linking the dorsal-aspect of the head to the angle of the jaw, *supratemporals* and *squamosals*; (e) investing the

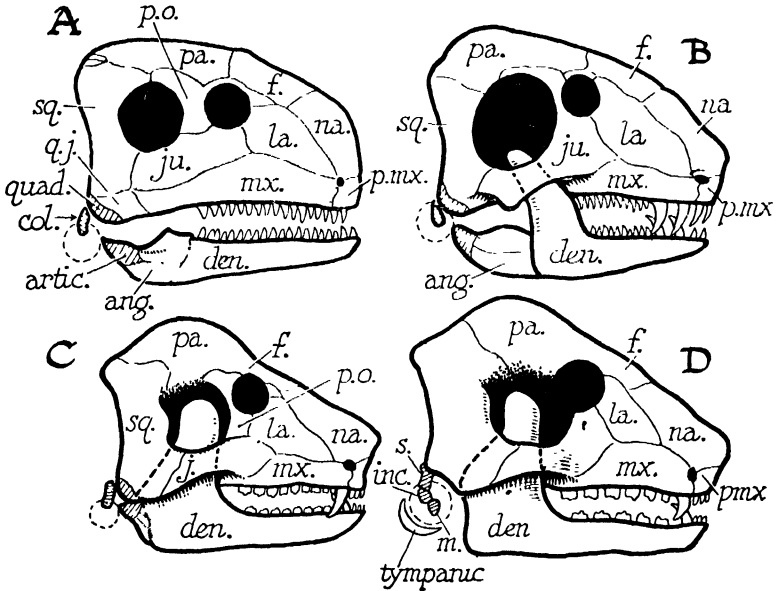

FIG. 143—COMPARISON OF SKULLS OF REPTILES AND MAMMAL (Diagrammatic)

(A) Upper Permian Therapsid; (B) Lower Triassic Therapsid; (C) Late Triassic Therapsid; (D) Mammal. See Fig. 141 for names of bones.

outer-aspect of the lower jaw, *supra-angulars*, *angulars*, and *dentaries* (the latter alone tooth-bearing). To this must be added certain elements that are not superficial in position, but arise from the skin and are not performed in cartilage. In the roof of the mouth there are three pairs of teeth-bearing bones, the *palatines*, *transpalatines*, and *pterygoids*, which invest the anterior end of the quadrate cartilage. Anterior to these on the roof of the mouth are a pair of

teeth-bearing scales known as the *vomers* and a median bone known as the *parasphenoid*. On the inner aspect of the lower jaw of either side there are three superficial bones known as the *splenials*, *coronoids*, and the *prearticulars*. Of these elements the tabulars, supra-temporals, and postfrontals are not represented in extant land Vertebrates.

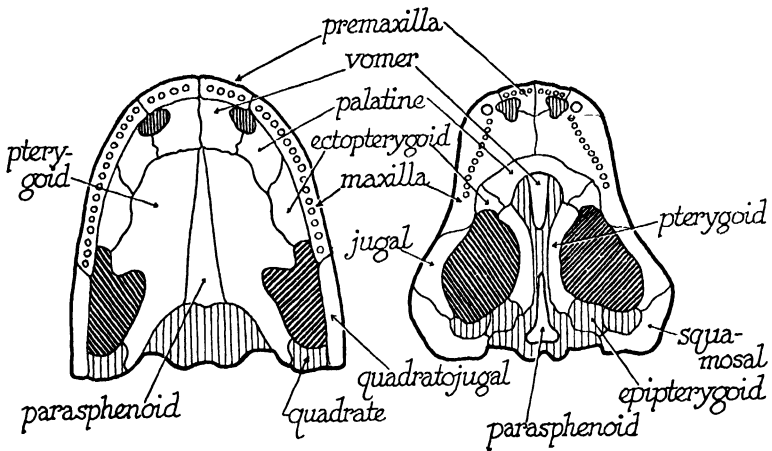

FIG. 144—THE PALATAL AND UPPER JAWBONES OF A STEGOCEPHALIAN OR COTYLOSAUR (PERMIAN) ON THE LEFT; AND OF A LATE TRIASSIC THERAPSID REPTILE ON THE RIGHT

The names of the various bones which are formed by ossification of different parts of the embryonic skull of Ganoids, bony fishes, and land Vertebrates are given in Fig. 139. The only outstanding difference between the *chondrial* bones of fishes and of Tetrapods has been mentioned above. One of the most interesting things about the earliest land Vertebrates is the fact to which they owe their name. The head of the Stegocephali was enclosed in a helmet of dermal bones embossed like the scales of the head region in Ganoid fishes; and the correspondence of the constituent

elements enumerated in the previous paragraph to those of the scaly helmet of Ganoids is easily recognizable. Thus the Stegocephali did not have a composite skull like that of all modern Amphibia. The skulls of modern Amphibia are much less like those of a Ganoid fish than are those of the

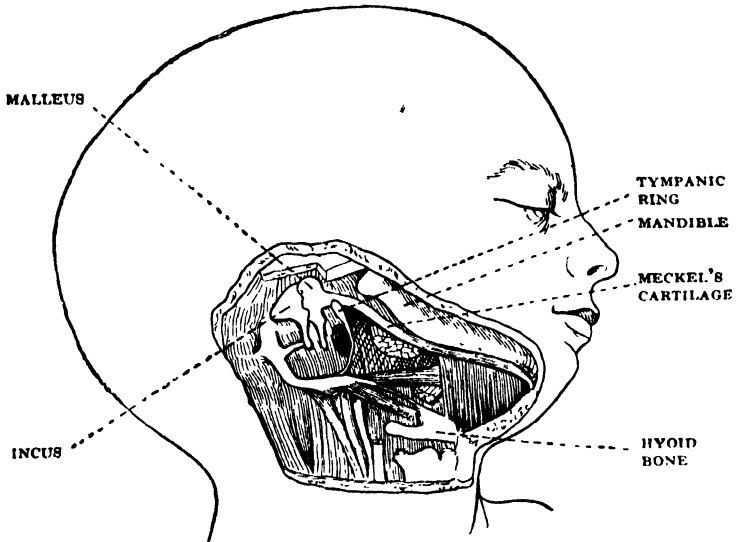

FIG. 145—HEAD OF HUMAN FŒTUS

Showing the two extra ear ossicles: Malleus (articular) and Incus (quadrate).

first fossil Amphibian types. We may indeed go farther and say that the skulls of the first land Vertebrates were far more like the skulls of Ganoid fishes than like those of living land Vertebrates.

In the Permian appear land Vertebrates with more massive limbs and limb girdles provided with well-developed ribs which invest the trunk to form a bony chest. These earliest reptilian forms, or *Cotylosauria*, of which *Pariasaurus* is an

example, possessed a skull that was well roofed in and had an aperture for the eyes only. It is more solid and compact than that of the typical Stegocephalian, and the superficial bones, though still grooved, are less obviously like scaly plates. In one respect the skeleton of the Cotylosaurs is more like that of mammals than is the skeleton of their contemporary reptiles. The pelvic girdle is tilted slightly backwards rather than forwards. From the lower to the upper Triassic beds, we can now trace a series of forms which show increasing approximation to the mammalian type of skeleton in every particular. The series is referred to by the term *Therapsida* or *Thermomorpha*, and is abundantly represented by well-preserved remains in the Karroo deposits, recently studied by Broom, Watson, and Haughton.

With the enlargement of the brain which attains its maximum development in the Mammalia the brain cavity has expanded upwards, so that the squamosals take a share in the lateral wall of the brain case, the otic bones become ventrally displaced below them, and the parietal bones, which are typically flat in reptiles, become arched and often crested for the insertion of the more powerful jaw muscles. In the temporal region there is a widely open fossa which generally includes the orbit and is bounded by a laterally projecting cheek bone, the *zygomatic arch*, formed by the union of the jugal and squamosal. The lower jaw projects upwards under the cheek bone and articulates against the squamosal.

Early members of the Therapsid series (Fig. 143 A) such as *Moschops*, which appears in the Upper Permian, show a more decided tendency in their limb structures to lift the body well off the ground, than did the Cotylosaurs. The backward tilt of the pelvic girdle is more pronounced. In

the skull the only noticeable innovation is the appearance of a large vacuity in the investing bones at the side of the head, bounded by the postorbital, jugal, and squamosal bones. The appearance of this vacuity heralds the emergence of a mammalian feature seen increasingly in the skull of

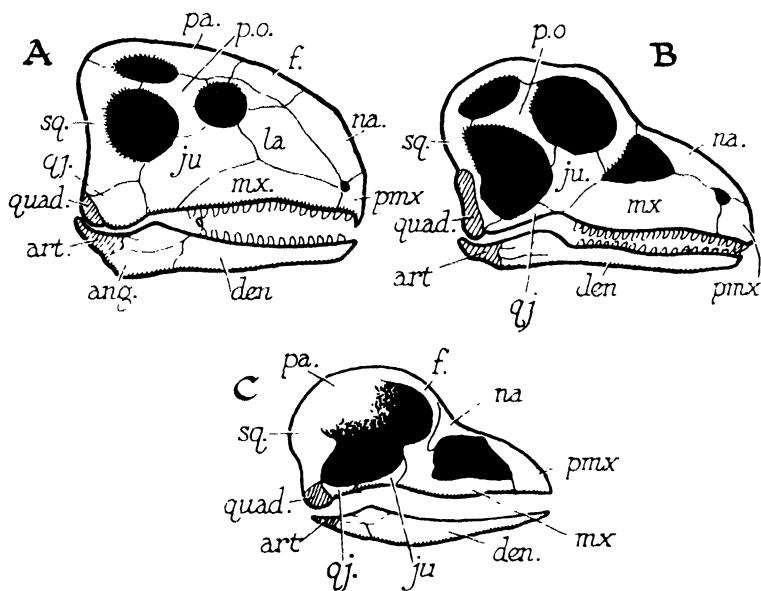

FIG. 146—SKULLS OF: (A) RHYNCHOCEPHALIAN (PERMIAN); (B) DINOSAUR (JURASSIC); AND (C) MODERN BIRD—diagrammatic

middle and upper Triassic forms. This is the bulging outwards of the cheek region to form the characteristic mammalian zygomatic arch. In the next stage (B) we see two new features well represented in a form such as *Lycosuchus*, first the increasing size of the dentary which now sends back under the projecting cheek bone a large process, and secondly the beginnings of a carnivorous type of dentition. In late Triassic Theromorphs (C) such as *Cynognathus*, *Gomphogna-*

thus, and Galesaurus, the differentiation of the teeth into incisors, canines, and molars is definitely mammalian, but even more important are two other features which respectively concern the jaw articulation and the palate. The accessory jaw elements, now on the point of disappearing, are loosely applied to the inner surface of the dentary, which has encroached so completely upon them that its posterior margin practically rests against the squamosal. So the quadrate and articular are ceasing to constitute the effective jaw articulation. In the late Theromorphs like Cynognathus, with well-developed carnivorous specialization, the maxillary and palatine bones send inwards plates which meet in the middle line below the narial aperture, forming the type of palate which is found in mammals but is not peculiar to them.

We have now seen that the Theromorph reptiles furnish a skull series which displays every gradation between the generalized land Vertebrate type of jaw structure and that of mammals. We have still to account for another outstanding peculiarity of the mammalian skull. The mammalian skull has three ear ossicles of which the innermost clearly corresponds to the single ear ossicle (*columella* or *stapes*) which rests against the quadrate in other Tetrapods. The two outer ones are preformed in cartilage from the articular end of the cartilaginous embryonic upper and lower jaws. That is to say, the middle one (*incus*) corresponds to the quadrate and the outer one (*malleus*) to the articular bone. Thus the displacement of the old jaw suspension in the Theromorph has made way for the incorporation of the two distinctively new mammalian ear ossicles. The mammalian tympanic bone which surrounds the middle ear probably corresponds to the angular.

Similarities between Theromorpha and mammals are not confined to the skull. In the later Theromorphs the shoulder blade has the trihedral shape which is so characteristically

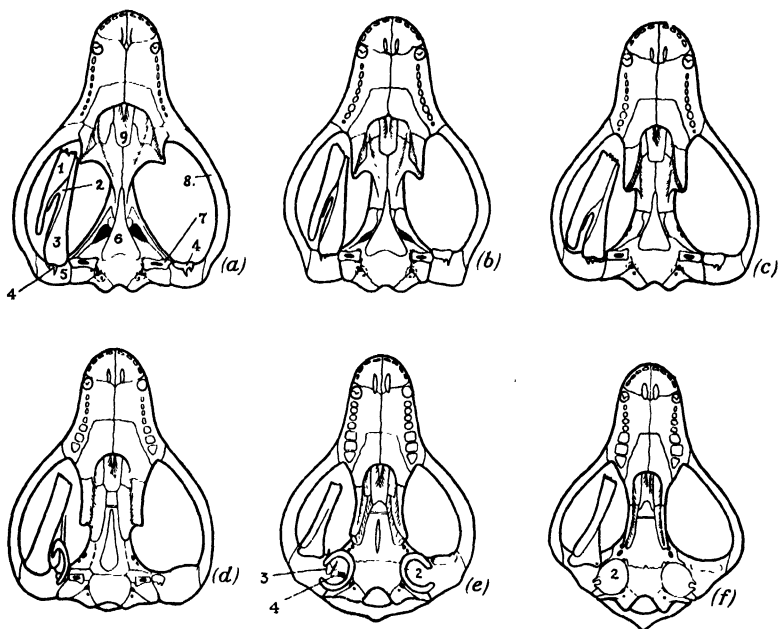

FIG. 147—EVOLUTION OF THE JAW SUSPENSION OF MAMMALS
(ventral aspect, after Westoll)

(a) *Threnaxodon* (Theromorph), (c) *Ictidosaurus* (Theromorph), (e) Young *Galeopithecus* (Mammal), (f) *Canis* (Mammal). Stages (b) and (d) are hypothetical.

The bones numbered are: (1) dentary, (2) angular, (3) articular, (4) quadrate, (5) squamosal, (6) parasphenoid, (7) stapes, (8) jugal, (9) vomer.

mammalian. The axial skeleton of Theromorphs also displays a few features which call for special attention. The vertebral centra of the Cotylosaurs are of the biconcave type. In the late Theromorphs the articular facets are flatter. In mammals they are quite flat, so that the notochord does not persist at all in adult life. The number of neck vertebrae

in Cynognathus and in mammals is fixed (*seven*), and the fact that it is identical in the whale and the giraffe affords an excellent illustration of Unity of Type. In *Platypus*, as in Theromorphs, there are vestigial cervical ribs. In other mammals they are completely fused with the vertebræ, but the interspace between the two heads of the rib persists as a canal on either side of the vertebra.

At the end of the Permian we find representatives of an order of reptiles (*Rhynchocephalia*) which have left one survivor in modern times, the New Zealand lizard, *Sphenodon*. They differ from the Cotylosaurs in one striking particular, the presence of two large vacuities at the side of the skull. One, like the temporal fossa of Moschops, is between the postorbital, squamosal, and jugal bones, and one between the postorbital, squamosal, and parietal bones. So the side of the head has two conspicuous bony arcades. Other minor features of the Rhynchocephalian skeleton are the tendency as in all modern reptiles for the pelvic girdle to be tilted forwards, and the presence, as in birds, of prominent projections (uncinate processes) on the posterior margin of the ribs. From the early Triassic Rhynchocephalia we can trace series leading in different directions to birds and to crocodiles. The skulls of Dinosaurs had the two large temporal vacuities of the Sphenodon skull, but in addition, as in birds, there were large vacuities in front of the orbit. In some of the Triassic Dinosaurs (e.g. *Anchisaurus*) the postorbital bones and the lower temporal arcade were very slender, so that apart from the presence of the former, which has disappeared in birds, the skull is essentially avian.

Another series connects the Rhynchocephalia with the crocodiles. It is well represented in the Triassic and Jurassic strata. The chief change in the skull is the elaboration of the

characteristic false palate of the crocodiles, in which the pterygoids as well as the palatines and maxillæ participate to shift the internal narial aperture far backwards. In addition we see the progressive solidification of the vertebral centra. Tortoises also have a false palate of the mammalian type. The earliest tortoises go back to the end of the Permian, and possessed a skull without any lateral vacuities like that of the Cotylosaurs. Some tortoises share with two wholly fossil aquatic or semi-aquatic orders, the *Plesiosaurs* and *Ichthyosaurs*, a vacuity in the temporal region corresponding to the lower one in the skull of Sphenodon. The stages which connect the tortoises with the early reptilian stocks are not yet elucidated, and in one respect the story is discontinuous in that the pectoral girdle of tortoises lies inside the ribs. It is noteworthy that the Chelonian stock was emerging before the complete investment of the thoracic region was effected. Lizards and snakes which are the most successful modern Reptilia appeared last of all. The distinctive feature of this order of reptiles (*Squamata*) is the fact that the quadratojugal has disappeared, so that the quadrate is moveable. The lower arcade of the Sphenodon skull is thus absent. There is an upper arcade in most lizards. With the elimination of the postorbital bone this has disappeared in the snakes and in geckos.

The task of elucidating the details of structure in fragmentary remains is often a difficult one, and the student may justifiably be tempted to surmise that a good deal of imagination is incorporated in the sometimes fanciful reconstructions that are figures in many semi-popular works. Nevertheless, there are certain broad general conclusions now well accredited by well-nigh complete skeletons of a large number of fossil genera and supplemented by innu-

merable less complete remains which confirm them. We know almost as much about the skeletons of *Pariasaurus*, *Archæopteryx*, *Cynognathus*, for instance, as we do about that of a living Vertebrate. Laying aside speculative interpretations and exaggerations the following points are sustained by ample data:

- (1) There was a time when the only Vertebrates were of the Piscine type;
- (2) Previous to the appearance of land Vertebrates there existed fish which resemble those living fish which most nearly approach the land Vertebrates in their respiratory and circulatory arrangements;
- (3) The first land Vertebrates with terrestrial limbs in the early Carboniferous have skulls of which the superficial bones are scaly plates like those which cover the head region in the Ganoid fishes;
- (4) At a later date, in Permian times appeared reptilian forms with large limbs and a bony chest, animals that no longer waddled but lifted the body well off the ground;
- (5) During the time intervening between the appearance of the first reptiles and the emergence of true mammals and birds in the Jurassic there were reptiles which in every feature of their organization show bird-like or mammal-like characteristics seen neither in modern reptiles nor in the Permian forms.

TOPICS FOR HOME STUDY

1. Describe the evolution of the pentadactyl limb.
2. Discuss the affinities of skeletal head pattern in modern vertebrates.
3. Describe the peculiarities of the axial skeleton in the various vertebrate groups.
4. What are the homologues of the mammalian ear ossicles in other vertebrates.

CHAPTER XIII

EVOLUTIONARY THEORY TO-DAY

IN the closing years of the eighteenth and the first few decades of the nineteenth century, evolutionary speculation was encouraged by two circumstances. One was that the progress of systematic comparative anatomy led to recognition of unity of type transcending similarities of habit and habitat. The other was the growth of materialism in the period of intellectual ferment which immediately preceded and followed the French Revolution. Without attracting much comment from the world at large or exciting much discussion among other naturalists evolution was defended in England by Dr. Erasmus Darwin, the grandfather of Charles Darwin, in France by Lamarck and St. Hilaire, and in Germany by the poet Goethe, who devoted his earlier years to anatomical pursuits and put forward an ingenious but entirely erroneous scheme of the homologies of the skull bones. These pioneer evolutionists based their belief on the prevalent superstition that acquired characters are hereditary. For various reasons they exerted very little influence. The materialistic temper of the period which witnessed the French Revolution had somewhat subsided. The fossil record was a sealed book, modern views about the age of the earth were not yet generally accepted, very little information about the anatomy of the Invertebrate groups was available, the essential nature of sexual reproduction was not fully recognized, and scarcely anything was known about the development of animals. Before the full significance of unity of type could be appreciated the detailed anatomy of a much

wider range of animal types remained to be studied. The existence of vestigial structures did not attract much attention until the compound microscope gave a new impetus to embryological research which developed rapidly between 1830 and 1860, when Darwin's *Origin of Species* was published.

The Principle of Succession, which emerged with increasing force as the chronological order of the sedimentary rocks was established, and as their fossil relics were unearthed during the first half of the nineteenth century, showed that the gaps between the well-defined classes of living creatures are filled in by intermediate forms which lived on this earth in past epochs. Different species of animals and plants have lived at different times in the past. Different species of animals and plants live in different places to-day. The geological record shows that fossil representatives of a group are usually more alike, if they belong to the same strata, i.e. they are more alike, if they lived about the same time. A corresponding generalization is broadly true about related species which live in the same geographical region. For instance, all the species of the kangaroo family live in Australia, and all the species of the armadillo family live in South America.

The Geographical Distribution of Animals.—The scorpion family provides a good illustration of the fact that geographical propinquity is generally associated with greater similarity of structure. Six families of scorpions are commonly recognized. If we exclude the neighbourhood of the Suez Canal and a small part of Morocco, only two families, the *Scorpionidæ* and the *Buthidæ*, are represented on the African continent. Species belonging to both these families are also found in Asia south of the Himalayas, in Australia, and in Central and South America. In the remotest part of

the African continent, the Cape Peninsula, the Scorpionidæ are represented by one genus, *Opisthophthalmus*, and the Buthidæ are represented by three genera, *Uroplectes*, *Parabuthus*, and *Buthus*. *Opisthophthalmus* and *Uroplectes* do not extend north of the Equator. *Parabuthus* extends beyond the Suez into Arabia, and *Buthus* ranges over South Asia. None of these four genera contains species found in Australia or America. The Cape species of Scorpionidæ belong exclusively to a genus which has no representatives north of the Great Lakes. The Cape species of Buthidæ belong to one genus which is exclusively South African, to one genus with species in the part of Asia nearest to Africa, to one genus with species distributed throughout South Asia, and to no genera with American and Australian representatives.

While belief in special creation was prevalent, the only explanation offered for the connexion between geographical propinquity and structural similarity was that animals and plants have been placed by Providence in the station of life to which they are best fitted. Colonial enterprise and horticulture both show that this is not necessarily true. At the beginning of the nineteenth century there were no rodents in Australia, where the rabbit has become a proverbial pest. A few blackberry seeds transported to New Zealand sponsored a blackberry plague which is a serious agricultural problem. Less than two centuries have elapsed since commerce with New Zealand began. There were then no indigenous mammals on the islands, where twenty-five imported species are now living freely in the wild state.

Exploration and new amenities of transport during the imperial expansion of the nineteenth century provided new opportunities for examining other circumstances associated with the fact that related species live in restricted localities.

The two most obvious are: (*a*) the ease with which different groups of species can travel, on account of their locomotory organs or devices for seed dispersal, and (*b*) the physical obstacles which they encounter in spreading far afield. In general, groups of species which can most easily surmount barriers of ocean, mountain, or desert spread themselves over wider areas. While bats are cosmopolitan, terrestrial mammals and Amphibia (frogs and salamanders) are not found on islands separated by a wide stretch of deep water from the mainland.

The great traveller naturalists of the nineteenth century made a close study of island faunas, and compared them with the faunas of the nearest adjacent land. The animal and plant populations of some islands are made up mostly of species which also live on the nearest adjacent land areas. Other islands are populated almost exclusively by species which are *endemic*, i.e. are not found elsewhere. Islands of the first class are generally near the mainland and are not separated from it by a great depth of ocean. Islands of the latter class, called *oceanic* islands, are separated from the mainland by a great depth of water. They may be volcanic, and if so have never been connected with the adjacent land area; or they may have remained separate from it for a long period of geological time. The Cape Verde Islands off the west coast of North Africa are volcanic islands. New Zealand, which is separated by a deep channel from the Australian land mass, appears to have been separated from it in Jurassic times.

The following tables taken from Romanes, a contemporary of Darwin, are still representative. St. Helena, Galapagos Islands, and the Sandwich Islands are typical oceanic islands separated by a great depth of water from the mainland. In

glacial times the British Isles connected with the mainland of Europe. The British Isles include about a thousand islands large and small. St. Helena is a single volcanic rock.

The geological record furnishes one clue to the meaning of

A. PECULIAR OR ENDEMIC SPECIES

	Land Molluscs	Insects	Reptiles	Land Birds	Mammals
Sandwich ..	400	?	2	16	0
Galapagos ..	15	35	10	30	0
St. Helena ..	20	128	0	1	0
British Isles ..	4	149	0	1	0

B. NON-PECULIAR SPECIES

	Land Molluscs	Insects	Reptiles	Land Birds	Mammals
Sandwich ..	0	?	0	0	0
Galapagos ..	?	?	0	1	0
St. Helena ..	0	?	0	0	0
British Isles ..	83	12,551	13	130	40

this contrast. We know that the species which now live in Europe have changed very little since glacial times, when the shallow channel between Britain and the mainland was established. In other words, many British species are still identical with European species which already existed when Britain was still part of the European mainland. The vastly deeper channel which separates New Zealand from Australia points to a much longer period of isolation. So fewer existing Australian species are identical with species which existed

when New Zealand was part of the same land mass. Of 1,040 species of New Zealand butterflies, 63 are Australian, 24 are cosmopolitan, and the remaining 91 per cent are endemic.

Colonial experience furnishes a second clue to the peculiar faunistic features of oceanic islands. Carnivorous mammals, such as stoats and foxes, which prey on rabbits elsewhere, do not exist in Australia. Circumstances which keep down the rabbit population of other regions were therefore lacking, and they multiplied accordingly. Conversely the introduction of new predatory species by colonists has resulted in the rapid extinction of pre-existing species, like the Dodo. Animals brought at rare intervals by drifting log-wood and seeds dropped by birds can multiply on volcanic islands without competition from predatory species on the mainland. So they may survive in their new surroundings, while their relatives on the adjacent mainland are making way for other species.

Families (e.g. Scorpionidæ) generally have a more widespread distribution than the genera (e.g. Opisthophthalmus) placed in them; and include species which have been separate for a longer period of geological time than species placed in a single genus. So species placed in different genera of the same family have usually had a longer period for spreading far afield than species placed in the same genus. In short, all the facts of the geological record and of geographical distribution point to the same conclusion. New species are continually appearing and old ones are continually disappearing. Four years before Darwin's first book appeared Wallace summed up the known facts about distribution in time and space at the conclusion of his paper entitled *On the Law which has Regulated the Introduction of New Species*;

“every species has come into existence coincident both in space and time with a pre-existing closely allied species.”

The Theory of Natural Selection.—Wallace and Darwin, whose restatement of the evidence which had accumulated during the first half of the nineteenth century gained general acceptance for the modern doctrine of evolution, approached the problem from the standpoint of the traveller-naturalist in the light of the new knowledge gained through exploration, colonization, and ocean travel. To the question why do some types exist only in one locality and others only in a different one, their answer was that new heritable types which turn up in the normal process of generation survive in competition with others which have disappeared because they are more fertile or more viable in the particular habitats which they penetrate in search of food. Both Wallace and Darwin stressed the fact that a relatively small proportion of progeny produced in every generation survive to produce offspring. Genetic variations will sometimes diminish the chance of survival, and sometimes increase it. Which variations, or, as we should now say, *mutant* characters, favour survival will depend on the demands imposed by a particular habitat. Thus *nature selects different genotypes in different habitats*. The barriers of ocean currents, mountain ranges, and the like perform the same function as the wire netting or fence by which the stockbreeder or fancier perpetuates new domestic varieties.

Darwin and Wallace concluded that natural varieties can arise in this way from the practical experience of the horticulturalist, the stockbreeder, and the fancier. To-day we can study in the laboratory how new hereditary types or mutants arise. We know that mutants breed true to type when mated *inter se*. We also know that mutant genes are not diluted by

inter-crossing and that new true-breeding combinations of mutant genes can be produced by hybridization. That *natural selection* of different genotypes will occur through the spread of species into different habitats and the changing conditions of life in the situations where they find themselves is beyond reasonable doubt. That if this process goes on sufficiently long they will become so unlike that they are incapable of interbreeding, when barriers which separate them disappear or other circumstances which prevent them from invading the same area are removed, is a conclusion about which no modern biologists disagree. It does not follow from this that new species only arise in this way, and Darwin himself did not assert it. He also recognized a second type of species formation by sexual selection (*vide infra*).

There is, in fact, no single problem of the origin of species. There are many problems of the origins of species, arising partly from the fact that all biologists do not always use the word "species" in the same sense, and partly from the fact that new genotypes may arise in more than one way. Owing to the large-scale importation of alien types for hybridization with a view to the production of new horticultural products, botanists are able to draw a clear-cut distinction between *varieties* and *species*. Individuals are classified in different varieties if they have recognizably different heritable properties and are still capable of producing fertile hybrids. Whether they do so in fact may depend on whether they are prevented by geographical circumstances or by human interference from so doing. Different species, on the other hand, cannot interbreed successfully. Either they do not produce offspring or produce sterile hybrids. Zoologists cannot make the same clear-cut distinction, because far fewer possibilities of testing this possibility under suitable conditions for the

much greater number of animal species now named exist. When intermediates occur in regions where the distribution of two types overlaps, it is generally assumed that natural hybridization occurs freely and the types are not regarded as true species. When the geographical barriers to dispersal prevent this, we have usually no means of knowing whether it would be possible in suitable circumstances.

Thus the distinction between a geographical variety and a species of animal is not a clear-cut one. While there is no doubt that geographical varieties are often true species in the making and that when closely allied species occur in the same habitat they have invaded it after a long period of separation during which accumulated differences have gone so far as to make them intersterile, there is also no doubt that new species can arise in one and the same habitat. In Darwin's generation this led to some controversy between botanists and zoologists, partly because the latter were more preoccupied with the newly discovered data of geographical distribution and hence with the fact that closely allied species are generally found in different habitats. The occurrence of closely allied species in the same habitat constitutes a different problem which botanists are forced to recognize more clearly than do zoologists for a reason which is now easy to understand.

In Chapter VIII we have met with two different ways in which new genotypes may arise. The most common is *gene mutation*, which is a chemical change restricted to a particular locus of a chromosome. There is also *chromosome mutation*, as when XXY females or triploid fourth chromosome flies are produced by non-disjunction. In one type of chromosome mutation called *polyploidy* each chromosome may be represented three times, four times, etc. Although chromosome

mutations need not be associated with visible differences of structure, polyploids generally show very striking somatic peculiarities and are often partially or wholly intersterile with the stocks from which they originate. If a polyploid of this kind arose in a bisexual species of animal it could not perpetuate itself unless there was an epidemic of similar chromosome mutations at the same time, and we do not know that this occurs in nature. Since most animals are bisexual, this method of species formation cannot be very common among animals. It is known to exist among some *parthenogenetic* types and it could presumably occur in hermaphrodite species which are capable of self-fertilization, or species which reproduce *vegetatively*, such as corals, sea squirts, or polyzoa. On the other hand, nearly all plants reproduce vegetatively. The overwhelming majority of plants are hermaphrodite, and unlike most hermaphrodite animals, are capable of self-fertilization. It is now known that chromosome counts of many closely related species of flowering plants are multiples of the same number. Hence there is no doubt whatever that a high proportion of plant species have arisen by chromosome mutation in one and the same habitat, and that though natural selection working upon a different material basis may exaggerate initial differences and widen the gap between them, it is not the correct explanation of their *origin*.

It is also true that gene mutations may make individuals more or less infertile with parent stock. Mutation of this kind would have no chance of survival in a bisexual species. On the other hand, it would offer no serious obstacle to survival in species which reproduce asexually, in self-fertilizing hermaphrodites, or in animals, such as *aphides*, which have a regular alternation of parthenogenetic and bisexual generations. Such alternation of generations also occurs in the gall

flies. Of the sixty-eight species of British gall flies, fifty-four parasitize the oak, and there is nothing to suggest that this immense proliferation of species for one and the same host plant is mainly due to specialization resulting from a predilection for different parts of the plant.

Since more retarded types would have greater opportunities of interbreeding, gene mutations might lead to species formation in one and the same environment by retarding sexual development or by producing precocity and by promoting earlier or later emergence of the adult from a larval phase. In this way species formation might proceed gradually in the same environment. Needless to say, it might also happen as a response to environment through natural selection imposed by conditions of climate. A good example of this among animals is difficult to find, because experimental studies of natural evolution are still in their infancy. An interesting illustration from plants is the Linnean species, *Primula vera*, which includes both the primrose and the cowslip. Fertile hybrids (sometimes called oxlips) of cowslips and primrose are easy to produce. In nature they are rare for two reasons. Cowslips do not begin to blossom until the flowering time of the primrose is nearly over, and primroses are rarely found in open fields where cowslips abound. Here we have a species difference which is incipient. If the flowering times were more restricted, they would live side by side in the same locality as clear-cut species, and no botanist would hesitate to label them as such.

Another sort of species formation is foreshadowed in Darwin's theory of *sexual selection*. It is obvious that animals display secondary sexual characteristics which have no survival value except in so far as they are marks of sexual recognition. To account for the secondary sexual differences

which some species such as pea-fowl display, Darwin suggested that the natural process of variation may result in different preferences of the male or of the female for its mate. Such differences could, of course, lead to the selection of different strains within the same habitat, and while accounting for the exaggeration of secondary sexual characteristics would also lead to species differentiation.

Darwin's sexual selection implies that mating does not occur at random. From this point of view it is a particular case of what may be a more general aspect of species formation in nature. Owing to their rarity mutants which are intersterile with the parent stock have no appreciable chance of surviving when mating occurs at random. On the other hand, the chance that a mutant of this kind could mate and establish a pure line in a bisexual species is not small in certain circumstances. One is that, as in many mammalian species, a small number of individuals are produced in a litter. The other is that owing to low density of population as with e.g. the otter in Great Britain, brother-sister mating or, at least, close inbreeding is obligatory. Most mutants are recessive. Recessive individuals can be produced from matings of two recessives, a recessive and a heterozygote, or two heterozygotes. If the gene is rare the first two will be very rare compared with the third. If the size of the family is very large, a quarter of the offspring will be recessive, and the chance that two recessives will interbreed is not small. If the size of the family is small the chance is much larger for the following reason. Let us suppose that the size of the litter is two. A quarter of the offspring of all matings between two heterozygotes will be recessive. Our census of all such matings will include some that have two wild-type offspring, many which contain one of each, and a few composed of two

recessive offspring. Thus the proportion of recessives in litters which contain at least one recessive will be much greater than a quarter, and can be shown by an application of elementary statistical principles to be more than a half.

We may sum up the preceding paragraphs in the following way. Darwin's hypothesis of natural selection undoubtedly shows how evolution may occur and does occur. Undoubtedly it is the correct explanation of why there exist so many wide gaps between genera, families, classes, orders, and phyla; why these groups are so often well-defined, and why so few intermediate types which make it difficult to construct a tidy classification survive in nature. On the other hand, it is undoubtedly true that selection for different habitats is not the only way in which species are made, and although many of Darwin's immediate followers believed so, Darwin himself did not believe that it was. One result of the exaggerated claims for natural selection which Darwin's followers put forward was the difficulty of explaining certain facts about the relations between animals and their habitats such as the very large proportion of cave animals which have degenerate eyes. If it were possible to find any rational basis for the Lamarckian superstition (i.e. the so-called inheritance of acquired characters) it might be possible to explain such phenomena. The fact is that as far as we know, it is no advantage for an animal that lives in the dark to have no eyes, and though it is easy to see why animals which have no eyes or have defective ones could manage to survive in caves, natural selection provides no explanation of why *so many* cave animals should have this characteristic.

We know that both eyeless and defective eye mutants occur in *Drosophila* and in other animals. We know that the same mutants do occur again and again. If there is no disadvantage

in possessing defective eyes, the proportion of individuals which have defective eyes will increase in every generation. So the eyeless condition or defective eyesight will eventually become characteristic of the species as a whole not as a result of selection for an advantageous character, but because of the *absence* of such selection. If we accept this straightforward explanation of the fact that cave animals are optically defective, we cannot stop there. We know that Trilobites have compound eyes, that *Limulus*, the most archaic living Arthropod, has compound eyes, that most insects have compound eyes, that many crustacea have compound eyes, and that one myriapod genus, *Scutigera*, which is not cryptozoic like other myriapods, also has compound eyes. We know also that land Arachnids which are usually cryptozoic have no compound eyes, that the cryptozoic wingless insects have no compound eyes, and that myriapods which, with one exception, are cryptozoic,* have no compound eyes. What is true of cave animals is therefore true of cryptozoic Arthropods. So the differentiation of species by the survival of mutants which have useless characteristics is not confined to cave animals.

Broadly speaking, we might say that when a species gets into a new environment it encounters circumstances which make new demands on the possibility of its survival and circumstances which relax previous demands. This means that apart from all the circumstances which promote species formation in the same habitat, natural selection in Darwin's sense of the term is not the only agency which accounts for species formation in different habitats. We have also to ask whether the mutation frequency of useless characteristics does not make an important contribution to evolution.

* *i.e.* live under stones, logs, bark, leaves, etc.

Although we now know some natural agencies such as temperature and X-rays which increase the frequency of mutation in the laboratory, we do not yet know very much about the frequency of mutations in nature. One thing we do know with certainty is that some animal types such as the lamp shell *Lingula* or the king crab *Limulus* have remained unchanged over vast periods of geological time. This suggests the possibility that the direct action of environment on the frequency of mutation varies considerably in different species, and therefore contributes significantly to the tempo of evolutionary change.

That what we inherit from our ancestors is their *genes* and not their *characters* has an important bearing on certain features of evolution which might otherwise be puzzling. Though we label a gene by its most striking effect on the structure or behaviour of an animal, there is no reason to suppose that its influence on development is confined to such more obvious characteristics as bar-eye or yellow body or vestigial wings in *Drosophila*. In fact, we know that the same genes have diverse effects. If a particular gene produces a difference which is advantageous or several differences which are advantageous when taken as a whole, it will be selected in nature. If it is also responsible for differences which have no survival value or might by themselves be slightly disadvantageous they will accumulate for the same reason, and eventually become characteristic of a stock living in a particular situation. For instance, a gene which promotes rapid growth may be selected in circumstances where early maturity is propitious to survival. If the result of more rapid growth due to the presence of the same gene results in the distortion of the skull or larger body size, selection will favour such distortion or gigantism in circum-

stances where these characteristics are themselves of no advantage in the struggle for existence.

Natural Classification.—The publication of Darwin's *Origin of Species* in 1860 intensified interest in the study of comparative anatomy and the classification of animals and plants, and encouraged some hopes which have not been sustained by experimental discoveries which have since been made. According to the evolutionary view unity of type is due to common ancestry. This statement is open to no objection if we remember that what we inherit from our ancestors is a *gene complex*. Zoologists of Darwin's generation had not got away from the habit of speaking about the inheritance of *characters*. Hence they believed it was possible to construct a *natural* system of classification in which the several divisions stand for assemblages of species which owe their common similarities to a common ancestor who possessed the same *characteristics*.

The fossil record provides abundant examples of forms which have developed striking similarities along independent lines. Hence we may draw a rough and ready distinction between similarities which are based on what biologists of a past generation would have called true *homology** and similarities based on *convergence*. As the immediate followers of Darwin interpreted the distinction, true homology was generally regarded as structural similarity associated with

* Zoologists have never been entirely consistent about the use of the word "homology" at any period. Thus current text-books use the term "serial homology" in two quite different ways. Sometimes it implies a recognition of structural similarities among organs which can be arranged in a series in one and the same individual, as when we speak of the homology of the fore and hind limbs of Vertebrates or of the mandibles and walking legs of an insect. Sometimes it is used to imply that segmental organs of different species occupy the same ordinal rank in the development of such a series as when we say that the mandibles of centipedes are homologous with the second antennæ of crustacea (see Appendix III).

descent from a common ancestor with the same characteristics. Convergent resemblance was structural similarity of species whose common ancestor did not possess the same structural characteristics. A distinction of this kind is quite easy to recognize when we have enough fossil evidence on which to base it, or when we are dealing with relatively large and homogeneous groups. We now know that it is not possible to make a clear distinction between true homology and convergent resemblance when we are dealing with closely related forms and have no *direct* evidence about their ancestry. Biologists brought up in the Darwinian tradition believe that they could do so when the resemblances were not "adaptive," i.e. when there was no reason to believe that similarities of habitat had independently encouraged the survival of similar variations in different stocks. From what has been said above, it is now clear that convergence is not restricted to useful characteristics. The fact that identical mutations turn up repeatedly in the same species furnishes the most reasonable explanation of non-adaptive characteristics such as the reduction of the eye in cryptozoic animals. So if similar mutations occur in closely allied species, similarities of non-adaptive characteristics do not justify us in believing that the common ancestor possessed the same characteristics.

To mutant genes of various species we can now assign an appropriate frequency or mutation rate. The gene responsible for "sugary" as opposed to starchy endosperm in maize turns up anew once in the production of 400,000 gametes. Haldane estimates that the gene for *hæmophilia* turns up about once in 50,000 generations. During the past twenty years chromosome maps like Fig. 94 of closely related species of animals and plants have been constructed from

the data provided by hybridization of mutant types. In such closely related species the correspondence of individual chromosomes is easy to recognize, and bodily differences due to mutant genes can be assigned to changes at a particular locus of a particular chromosome. By itself the fact that similar mutant characteristics turn up in closely related species signifies little, since different genes known to be located on different chromosomes or on different parts of the same chromosome may produce the same visible effect. For instance, several albino varieties both of the rabbit and of the fowl are visibly alike and genetically different. On the other hand, many similar mutants in closely allied species can now be referred to the same loci on the same chromosome, so that chromosome maps of allied species may resemble one another very closely. In *Drosophila simulans* Sturtevant has shown that some twenty-five mutants, similar to mutants in *D. melanogaster*, can be referred to genes with similar serial order on corresponding chromosomes. Thus yellow body, white-eye, and rudimentary wing genes occur in the same order in both species on the X-chromosome. A black-bodied, vestigial winged, and a truncated-winged mutant have been found in *Drosophila simulans*. Their genes occur as in *D. melanogaster* on the second chromosome in the same serial relation. There is a sepia-eyed mutant whose gene resides on the third chromosome as in *D. melanogaster*. There is the mutant "minute" with small fine bristles in both species, with its gene located on the fourth chromosome.

The importance of Sturtevant's work will be more clear if we consider two species, A and B, in each of which has appeared a series of recessive sports, *a*, *b*, *c*, *d*, *e*, *f*, and *g*. Their occurrence in nature will be occasional, and may well

escape the observation of the field naturalist. The geneticist, who is on the look-out for them, can isolate each, and thus build up a stock of A and another stock of B, each with the same combination of mutant characters, *a, b, c, d, e, f,* and *g*. A taxonomist who visited the laboratory and examined these cultures would find himself confronted by two species with a group of common characteristics which other species of the same genus *Drosophila* do not possess. Reassured by the convention that these characteristics are not "adaptive," he would deduce the existence of a common ancestor characterized with this particular constellation of mutant characters, and therefore feel justified in erecting a new *subgenus* to represent the separation of this common ancestor from the ancestral stock of other species of *Drosophila*. It is possible that Nature is continually playing practical jokes of this sort. Hence we cannot hope to represent evolutionary relationships in the final twigs of a classificatory system.

It is also very doubtful whether it is desirable to do so, because the real reason for encouraging systematic study of animal species is the need to identify them in the quickest and most convenient way when we wish to know whether we are talking about the same species or different ones. If we classified Vertebrates and Arthropods on a strictly evolutionary basis in the light of fossil evidence which we already possess, the various orders of *Myriapoda*, *Amphibia*, and *Reptilia* would be assigned the position of classes equivalent in rank to insects and crustacea, or to birds and mammals. Since Myriapods have common characteristics which distinguish them from all other classes of Arthropods, and since Amphibia and reptiles have many common characteristics which distinguish them from other Vertebrates, such a classification would be a less serviceable key to the identification

of a living species in the field than those which are usually adopted in zoological text-books.

It also follows from what has been said about the occurrence of similar mutations in related species that the laborious efforts of anthropologists to trace the evolution of the so-called races of mankind are largely futile. Preoccupation with the problem of geographical distribution in Darwin's time encouraged the study of the geographical varieties of the human species and it was too commonly assumed that differences of culture associated with differences of habitat have the same basis as the physical characteristics of human communities. This belief was entirely unwarranted. The evolution of human culture depends largely on circumstances which have nothing to do with changes in the genetical make-up of individuals. Human communities are forced to adopt different technical processes and social habits by the natural resources and physical limitations of the places where they live. They transmit their knowledge by *speech* or by its substitute writing, and not by their gametes. The culture level of different communities is a problem *sui generis*. It has little to do with evolution in the biological sense of the term.

In this connexion it is important to emphasize the fact that ethnologists do not always use the word "race" in a strictly genetic sense. It is undoubtedly true that people who live in some geographical regions have common heritable peculiarities which distinguish them from other people. When anthropologists use the word race in this sense they follow the same practice as biologists. It is also a fact that some genotypes which do not form compact communities are more frequent in some regions than in others. For instance, tall, long-headed people with fair hair and blue

eyes, are more common in Northern Europe than in other parts of the world. There is no evidence that there has ever been any time in the world's history when all the inhabitants of a particular locality had these characteristics. Though we are entitled to speak of a Nordic type, the Nordic race is a myth.

The Jewish race is also a misnomer. Human beings who are so classified include immigrants from Palestine or other parts of Asia Minor and their proselytes among Slav and Tartar peoples of Eastern Europe. Though there is a high concentration of some hereditary characteristics among members of the Jewish religion and their descendants because of the taboo which forbids interbreeding with those who do not share their peculiar dietetic preferences, no physical characteristics distinguish all Jews as such from any other people. Their common cultural characteristics are largely, if not exclusively, the product of a common tradition reinforced by persecution and restriction of civic privileges for many centuries.

TOPICS FOR HOME STUDY

1. How may new species arise?
2. What important facts emerge from a study of Geographical distribution?

APPENDIX I

CLASSIFICATION OF CRUSTACEA

OWING to the great variety of limb structures in the group and the diverse adult modifications of species with closely similar larval stages, the classification of the Crustacea is more difficult than that of other Arthropod groups. The following keys are constructed to draw attention to specially diagnostic features of the constituent orders. The student must bear in mind that a moron-proof guide to crustacean systematics cannot be constructed. Most orders include types which have no very obvious relationship to the more characteristic species. They are only placed with the latter because of the existence of less specialized types endowed with some of their peculiarities, or because earlier stages of the life cycle reveal similarities which are absent in the adult. The profound modifications associated with parasitism, leading in extreme cases to the disappearance of all specifically crustacean and even of all Arthropod characters in the adult, make it impossible to draw up diagnoses that will apply to all members of some of the groups. The systematic place of such specialized or degenerate types is indicated, however, either by intermediate forms linking them with the typical members of their groups or by the possession of characteristic larval stages. The best survey of the Crustacea is Calman's volume in the Oxford Treatise.

Any classification is primarily a means of identifying different forms. The doctrine of evolution implies that a classification based on *differentiæ* which draw attention to a complex pattern of resemblance broadly embodies the ancestral relations of groups. This is only true up to a point. So groups placed near one another in a key for quick identification are not necessarily related more closely on that account. The plan used in making the key is based on *convenience* alone.

Outline Classification of Crustacea

1. Branchiopoda
 - a. Anostraca
 - [b. Lipostraca (fossil)]
 - c. Notostraca
 - d. Diplostraca
 - (i) Conchostraca
 - (ii) Cladocera

2. Ostracoda
3. Cirripedia
4. Branchiura
5. Copepoda
6. Malacostraca
 - a. Phyllocarida (=Leptostraca =Nebaliacea)
 - b. Syncarida
 - c. Peracarida
 - (i) Mysidacea
 - (ii) Cumacea
 - [(iii) Thermosbænacea]
 - [(iv) Tanaidacea]
 - (v) Isopoda
 - (vi) Amphipoda
 - d. Decapoda (Eucarida)
 - (i) Euphausiidea
 - (ii) Penaeidea
 - (iii) Caridea
 - (iv) Palinura
 - (v) Astacura
 - (vi) Anomura
 - (vii) Brachyura

Diagnostic Features of Sub-classes.

Posterior Region of Trunk without Limbs.

Branchiopoda

Trunk-appendages nearly always flattened and lobed ("phyllopodous") number varying greatly ("anomeristic"), genital openings on same segments in both sexes. No mandibular palp. Shell-fold present or absent. Compound eyes present.

Ostracoda

Trunk-appendages not more than two pairs, varying in form, genital openings in same region in both sexes. Mandibular palp present. Shell-fold bivalve. Compound eyes present or absent.

Cirripedia

Trunk-appendages biramous, six pairs. Genital openings on different somites in the two sexes (♀ on first trunk somite, ♂ behind last limbs). No mandibular palp. Shell-fold forming a "mantle" enclosing body and limbs. Compound eyes absent.

Branchiura

Trunk limbs biramous (except first pair), five pairs. Genital openings on same somite in both sexes. Shell-fold absent. Compound eyes present.

Copepoda

Trunk-appendages typically biramous, six pairs or fewer. Genital openings on same somite in both sexes. Shell-fold absent. Compound eyes absent.

Posterior Region of Trunk with Limbs.

Malacostraca

Trunk limbs biramous or pediform, in two groups ("sonnet sequence" 8-6). Genital openings on different somites in the two sexes (♀ on 6th trunk somite, ♂ on 8th). Shell-fold present or absent. Compound eyes usually present. All somites may bear appendages except in Phyllocarida.

NOTE—Trunk limbs = limbs behind maxilla.

SPOT KEY TO THE SUBCLASSES

1. Genital apertures on the same segment in both sexes.
 - a. No mandibular palp; flattened appendages:

5 BRANCHIOPODA
 - b. Mandibular palp usually present (3 and 4)
2. Genital apertures of male and female on different segments.
 - a. Male orifice on 13th, female on 11th, all postcephalic segments bearing appendages *in sonnet sequence*:

6 MALACOSTRACA
 - b. Male orifices at end of abdominal penis, female orifice on 5th segment; six pairs of biramous postcephalic appendages 7 CIRRIPIEDIA
3. Postcephalic appendages not exceeding three in number; shell bivalve 8 OSTRACODA
4. Postcephalic appendages more numerous and biramous; no shell-fold.
 - a. With paired compound eyes 9 BRANCHIURA
 - b. Without compound eyes, usually with paired egg sacs:

10 COPEPODA

KEY TO ORDERS OF BRANCHIOPODA

- | | |
|---|---------------------------------|
| 1. Without shell-fold | ANOSTRACA [Lipostraca (Fossil)] |
| 2. With dorsal shell-fold | NOTOSTRACA |
| 3. With bivalve shell | DIPLOSTRACA |
| <i>a.</i> Postcephalic limbs
not less than 10. | Conchostraca |
| <i>b.</i> Postcephalic limbs
not more than 6. | Cladocera |

KEY TO CHIEF DIVISIONS OF MALACOSTRACA

1. Caudal furca present, seven abdominal somites in adult. Bivalve shell, flattened thoracic limbs PHYLLOCARIDA
2. No caudal furca, six abdominal somites in adult.
 - A. No shell-fold but first thoracic somite fused with head. No brood-pouch SYNCARIDA
 - B. Shell-fold present or absent, never fused with all thoracic somites. Brood-pouch present, development direct:

PERACARIDA
 - C. Shell-fold fused with all thoracic somites. No brood-pouch. Development usually with metamorphosis:

EUCARIDA (Decapoda).
 - D. Shell-fold fused with four thoracic somites. No brood-pouch. Development with metamorphosis. Two movable segments in front of head HOPLOCARIDA

KEY TO CHIEF ORDERS OF PERACARIDA

1. Pedunculate eyes. Shell-fold enveloping thorax but not fused with more than three somites. Tail-fan. MYSIDACEA
2. Eyes sessile, usually coalesced. Shell-fold fused with three or four somites, lateral lobes forming "pseudorostrum" in front. CUMACEA
3. Eyes on immovable peduncles. Shell-fold fused with two somites. TANAIIDACEA
4. Eyes sessile. No shell-fold but first thoracic somite fused with head. Abdominal limbs, biramous, lamellar. ISOPODA
5. Eyes sessile. No shell-fold but first thoracic somite fused with head. Abdominal limbs usually biramous, in two series (3-5). (Reduced or absent in Caprellidea) AMPHIPODA

KEY TO PRINCIPAL TRIBES OF EUCARIDA (OR DECAPODA)

1. "Petasma" on first pleopods of male. "Thelycum" or external receptaculum seminis in female. Nauplius larva.
 - A. Thoracic limbs nearly uniform, rarely chelæ on one pair. Gills in one series EUPHAUSIIDEA
 - B. First three pairs of thoracic limbs formings maxillipeds (third pair little modified). Chelæ on 4-6. Gills in three series. PENAEIDA
2. No "petasma" in male. "Thelycum" rarely present. No nauplius stage present.
 - A. Thoracic limbs 4-5 typically chelate. Pleura of second abdominal somite expanded CARIDEA
 - [B. Thoracic limbs 4-7 or 4-8 chelate ERYONIDEA]
 - C. No chelæ (except sometimes last pair in female) PALINURA
 - D. Thoracic limbs 4-6 chelate ASTACURA
 - E. Thoracic limbs 4 usually, 6 never, chelate. Abdomen generally soft, or flexed, or asymmetrical. Uropoda rarely absent ANOMURA
 - F. Thoracic limbs 4 chelate. Abdomen reduced, flexed symmetrical. Uropodas very rarely present as vestiges:
BRACHYURA

APPENDIX II

KEY TO THE CHIEF ORDERS OF INSECTS

I. Biting Mouth Parts.

A. Wingless—continuous development.*

- (a) With abdominal appendages.
 - 1. Apterygota (*silver fish, bristle tails, spring tails*).
- (b) Without abdominal appendages.
 - 2. Mallophaga (*bird lice*)

B. Winged.

(a) Development continuous.

- (i) Without forceps.
 - 3. Orthoptera (*cockroaches, locusts, crickets, stick and leaf insects*).
 - 4. Isoptera (*white ants*).
- (ii) With forceps and folded wings.
 - 5. Dermaptera (*earwigs*).

(b) Interrupted development—net wings.

- (i) Larvæ with inconspicuous caudal cerci.
 - 6. Odonata (*dragon flies*).
- (ii) Larvæ with conspicuous caudal cerci.
 - 7. Plecoptera (*stone flies*).

(c) Discontinuous development.

- (i) With tegmina.
 - 8. Colcoptera (*beetles*).
- (ii) Without tegmina.
 - Net winged.
 - 9. Neuroptera (*lace wings, ant lions, alder flies*).
 - Coarse veined.
 - With mandibles.
 - 10. Hymenoptera. (*Bees, wasps, ants, sawflies, gall flies*).
 - Mandibles vestigial or absent.
- 11. Trichoptera (*caddis flies*).

* In this table a distinction is drawn between *discontinuous* development, in the course of which the internal organs of the larva are dedifferentiated and the adult organs are reconstructed from a pulp of cells, in contradistinction to *interrupted* development in the course of which the internal larval organs pass over to the adult.

II. Sucking Mouth Parts.

A. Direct development.

(a) Wingless.

12. Anoplura (*lice*).

(b) Winged.

(i) Jointed proboscis.

13. Hemiptera (*plant bugs, aphids, scale insects, water boatmen, skaters*).

(ii) Unjointed proboscis.

14. Thysanoptera (*thrips*).

B. Discontinuous development.

(a) With four wings.

(i) With scales.

15. Lepidoptera (*moths, butterflies*).

(ii) Without scales.

16. Mecoptera (*scorpion flies*).

(b) With hind wings vestigial.

17. Diptera (*flies, mosquitoes, keds, midges*).

(c) Wingless.

18. Siphanaptera (*fleas*).

III. Mouth Parts Vestigial or absent.

(a) Four wings—interrupted development.

19. Ephemeroptera (*may flies*).

(b) Forewings vestigial—discontinuous development.

20. Strepsiptera (*stylops*).

HOMOLOGY OF INSECT MOUTHPARTS

The median hypopharynx as shown (where it can be easily seen) carries the orifices of the salivary ducts. The appendages—mandibles, maxillulae, first maxillae and second maxillae (labium) are indicated by shading. Equivalent appendages are easily recognized in orders with biting mouthparts (*Orthoptera, Coleoptera*, etc.) and in Hymenoptera, where biting (*sawfly, ants*), biting and licking (*wasp*) or licking and nectar-sucking (*bee*) types form a transparent series. The equivalence of the typical Lepidopteran mouthparts is established by the *Micropterygid* type with its curved *galea* of the first maxilla and vestigial mandibles. Among Diptera the styliform *galea* of the first maxilla is easily

distinguished from the styliform mandibles in *Tabanids*; and the palp is also recognizable as that of the first maxilla. For this reason the palp of other Diptera, e.g. *Culex* or *Muscids*, is regarded as equivalent. The equivalence of the Hemipteran mouth parts is not clarified by a good series of intermediate types. It is based chiefly on comparison of the jointed probosces with the fusion of the jointed bases of the second maxillae to form the labium in other insects. The sucking and piercing mouthparts of *fleas* (Siphonaptera), which are not included, are much like those of Diptera, but the *labium* is reduced and the tube is mainly formed by the epi-pharynx (*labrum*). Cross sections are drawn with the anterior-dorsal side uppermost. In full view diagrams as seen from the ventral side of the head the dorsal labrum epi-pharynx is not visible. Its relative position is indicated.

BITING MOUTHPARTS

(Apterygota, Orthoptera, Coleoptera and most Hymenoptera.)

- └— upper lip
- Labrum (Epipharynx)
- Mandible —jaws
- 1st Maxillae
- Labium —lower lip
- Hypopharynx — "tongue"

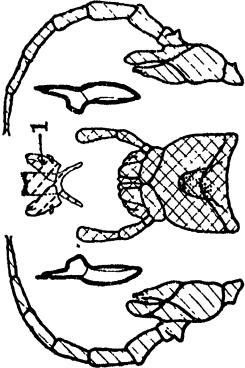

Apterygota (petrobilus)
ventral posterior view
1 maxillulae

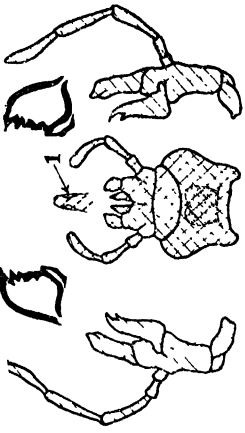

Orthoptera (blatta-cockroach)
ventral posterior view
1 maxillulae

Primitive Lepidoptera

Micropterygid

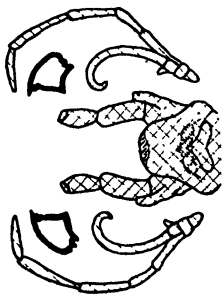

ventral posterior view

Primitive Diptera

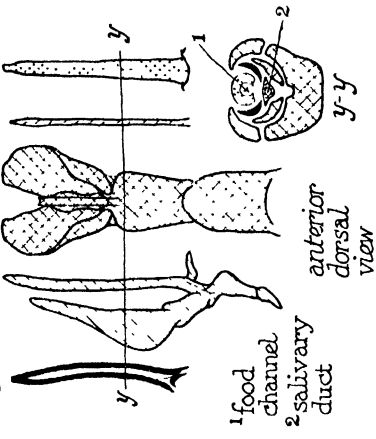

1 food channel
2 salivary duct
anterior dorsal view
y-y

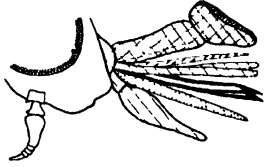

side view

Tabanus (cleg)

LICKING MOUTHPARTS

Hymenoptera (*Apis* - Bee)

proboscis
= labium

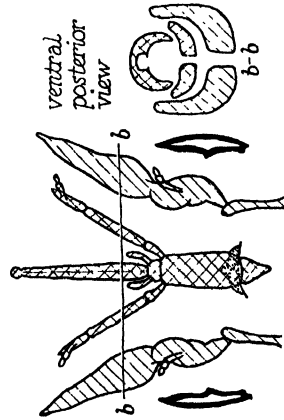
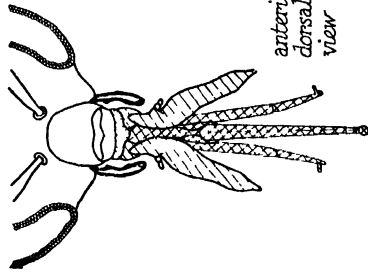

SUCKING MOUTHPARTS

Lepidoptera (Moth or Butterfly)

proboscis
= maxillae

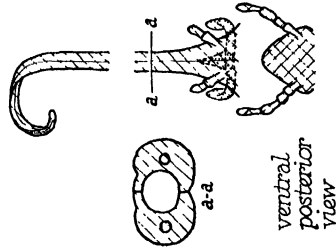
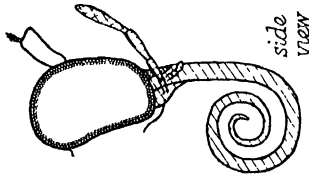

Diptera (*Musca* - Housefly)

proboscis
= labium

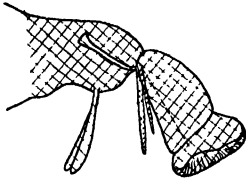

side view (\leftarrow anterior)

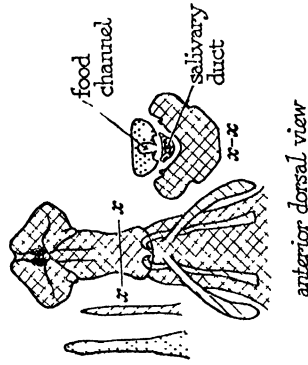

Diptera (Culex - mosquito)

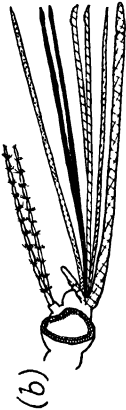

(a) feeding position
(b) with parts separated

PIERCING
SUCKING
MOUTHPARTS

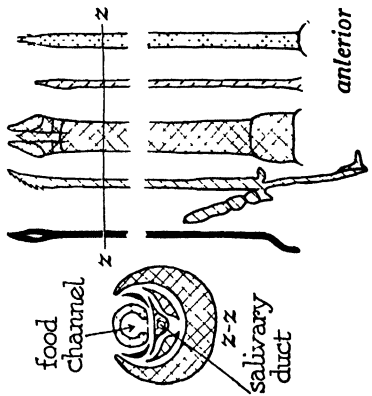
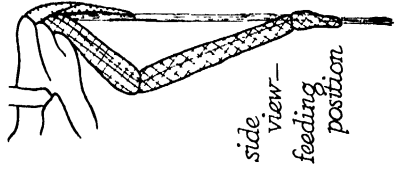

Hemiptera (Cimex - Bug)

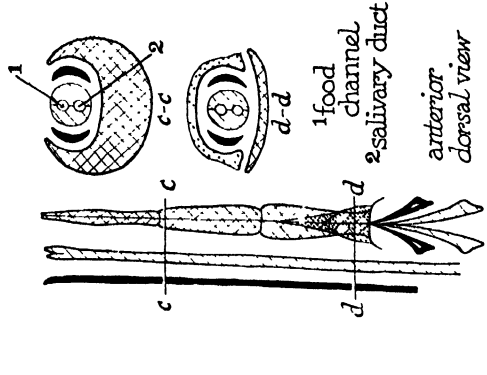
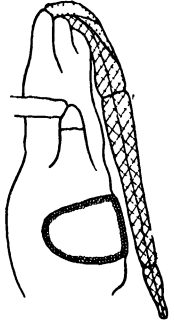

APPENDIX III

SERIAL HOMOLOGY

STUDENTS of zoology are often confused by the large number of technical terms used to describe the external anatomy of Arthropod types, when the latter are used to illustrate the meaning of serial homology. The following notes for laboratory work on the Norwegian Lobster (*Nephrops norvegicus*) may be used as a model for examining other Arthropod types to elucidate the serial similarities of the appendages and the nature of *metameric segmentation*.

1. *General Appearance*.—Note stalked eyes, two pairs of antennæ, one pair of chelæ (pincers), the cephalothorax to which are attached four pairs of walking legs. The sides of the cephalothorax overhang the bases of the limbs to which are attached the gills. The cephalothorax thus acts as a gill chamber. Note segmented abdomen. Each segment is encased by three elements, a broad dorsal plate or tergum, and a belly plate or sternum. The V-shaped edges of the dorsal plate are called the pleura. Note tail plate, or telson, on the under side of which opens the anus. Flex the abdomen and note the thin inter surface between the segments. From the ventral view note the mouth parts (see later under Appendages) and the abdominal appendages or swimmerets.

2. *Dissection*.—Dorsal. Chip off a small piece from the posterior end of the cephalothorax. This will expose the underlying organs. Remove the remainder of cephalothorax, taking care not to injure the underlying tissue. The organs are covered by a red epidermis. Lift the epidermis carefully, exposing the heart, an elongated body with dorsal, slit-like openings called ostia. If the animal is in good condition, identify the artery going forward, the ophthalmic or cephalic, and the paired side arteries arising from it. Identify the superior abdominal artery running along the dorsal surface. Near the heart identify a branch of the abdominal going down to the ventral surface, the sternal artery which penetrates the central nervous system.

3. Cut through and remove carefully the dorsal plates of the abdomen, exposing the underlying muscles. Separate but do not cut through these. Identify the hind-gut and the dorsal abdominal artery lying on top of this. Remove the digestive gland. Trace the duct of the gonad to an opening at the base of a walking leg (fourth

in the case of a male, and second in the case of a female). Identify the parts of the alimentary tract, the œsophagus, the gizzard, and the hind-gut.

4. Remove the viscera and clean thoroughly. Identify the central nervous system (paired strands) which lie ventrally. Separate and remove the muscles in the abdominal region. Pour 70 per cent alcohol on to the nervous system. Trace the C.N.S. forward to where it is enclosed by a cuticular arch. Chip away the arch and notice the opening in the C.N.S. through which passes the sternal artery. Note also the five ganglia in the thoracic and the six in the abdominal region. Trace the C.N.S. to the œsophagus by separating muscle, noting the sub-œsophageal ganglion. Note the passage of the œsophagus through an opening between two strands, the circum-œsophageal commissures, which unite forward to form the supra-œsophageal ganglion or brain. Lift the carapace in the region of the eyes and identify the nerves to the eyes and the antennæ. Note also the green gland at the base of the antennæ.

5. Identify the following paired appendages on the intact animal:

- (a) *Pre-oral* antennules and antennæ.
- (b) *Oral*, completely subordinated to masticatory use, mandibles, first and second maxillæ.
- (c) *Semi-masticatory*—intermediate between jaws and legs, three pairs “maxillipedes.”
- (d) *Post-oral* chelæ, and four walking limbs.
- (e) *Abdominal* five swimmerets, one terminal or tail-paddle.
Note the *biramous* character of the limbs in this series, with outer (exopodite) and inner (endopodite) branches.

6. Remove the third maxillipede of one side, extracting it at the base (the third maxillipede lies immediately in front of the chela or pincers). Then remove, in the following order, second maxillipede, first maxillipede, second maxilla, first maxilla, mandible, antenna, antennule. Lay these out in order, commencing with antennule, and number. Remove chela, four pairs of walking legs, and abdominal appendages.

- (a) Examine abdominal appendages 2-5, and the first pair of feelers, the antennules. Two-jointed base, except the antennules, which are three-jointed. This is called the protopodite. The appendage is biramous, the two similar parts called the

endopodite and the exopodite. This biramous appendage is the basic and ancestral type from which all the others have been derived, p. 337.

- (b) Note that in the last abdominal appendage, or tail-paddle, the exopodite is two-jointed, and the endopodite is one-jointed.
- (c) Note that in the antenna (the second pre-oral) the exopodite is one-jointed.
- (d) Note that the first abdominal appendage is rolled in the male, and rudimentary in the female. In the male it is a copulatory appendage, the sperm flowing along the groove.

7. Examine the appendage immediately in front of the claw. This appendage, like the two in front of it, is called a *maxillipede* or jaw-leg (i.e. it is the third maxillipede), so called because they are intermediate in character between the five thoracic limbs (the chela and the four walking legs) and the first three post-oral or *jaw-like* appendages. Note the double basal portion or protopodite, with filament of gill attached, the five-jointed endopodite, and the small jointed exopodite. Compare the three maxillipedes.

8. Compare maxillipede 3 with the chela and walking legs. Note that the chela and walking legs (the thoracic appendages) are endopodites.

9. Compare the first maxillipede with the three preceding appendages, viz. the mandible and the two maxillæ. Note that the basal segments constitute the biting part of the jaw, and that this becomes less marked as we progress to and along the maxillipedes away from the jaw. Note also the palp attached to the mandible.

10. Notice the gill filaments attached to the bases of the maxillipedes and the thoracic appendages. Also a corresponding attachment of the baler (scaphognathite) at the base of the second maxilla. The movement of the baler produces a respiratory current over the gills in the live animal.

11. Notice the following apertures :

The gonad at the base of the fourth walking leg in the male, and the second walking leg of the female.

The aperture of the green gland (antennary gland) at the base of the antenna (second pre-oral).

12. Note also the statocysts at the base of the antennule (first pre-oral).

APPENDIX IV

PARTS OF THE BRAIN

THE embryonic brain of a vertebrate is hollow and is usually 3-lobed. The most anterior lobe is called the prosencephalon, the middle one the mesencephalon and the hindmost the metencephalon. The anterior end of the prosencephalon becomes divided *laterally* into two lobes the *roof* of which corresponds to the cerebral hemispheres of a land vertebrate or Elasmobranch. The floor corresponds to the *corpora striata* which form the main part of the corresponding region of the brain of a bony fish. The posterior half of the fore-brain called the thalamencephalon has thickened side-walls, the optic thalami. Its roof is thin and carries the *pineal* body. Its floor is also thin and carries the *pituitary*. The roof of the mid-brain (mesencephalon) forms the optic lobes called *corpora bigemina* in vertebrates other than mammals. Those of mammals are bilobed, hence called *corpora quadragemina*. The optic lobes of birds are very large and displaced laterally. The roof of the hind-brain is generally thick and forms the cerebellum. Its floor is called the Pons Varolii. The *medulla* or bulb is the adjacent part of the spinal cord. The roof is thin and here (as elsewhere) the term *choroid plexus* indicates that it contains no nerve cells. The cavities of the region formed by the *corpora striata* and cerebral hemispheres persist as the *lateral ventricles*. That of the thalamencephalon is the *third ventricle*. The *fourth ventricle* is the cavity of the region where the medulla merges with the metencephalon.

INDEX

- Acalephæ, 292, 299, 308
 Acanthodei, 341, 347
 Acephala, 292, 299, 301, 310
 Actinopterygii, 341, 350
 Actionozoa, 43, 310, 317
 Adrenal body, 24 (ill.), 153
 Adrenal glands, 37 (ill.), 58, 165
 Adrenalin, 154
 Alimentary Canal, 55, 115 (ill.),
 116 (ill.), 121, 137, 157, 284, 288,
 293, 311
 Allantoidians, 297
 Allantois, 160 (ill.), 161 (ill.)
 Amia, 344
 Amioidei, 341
 Amœba, 252-256
 Amphibia, 44, 57, 58, 82, 148, 261,
 266, 280, 289, 348, 385
 skull of, 355
 Amphioxus, 325, 326 (ill.), 327 (ill.), 330
 Amylase, 120, 122
 Anallantoidians, 298
 Anemones, Sea, 301, 316
 Anenteræti, 310
 Animalia—
 Articulata, 292
 Mollusca, 291
 Radiata, 292
 Vertebrata, 291
 Annelida, 43, 291, 292, 293, 294, 296,
 297, 298, 302, 310, 311, 318, 323,
 324
 Annulata, 298, 302
 Anus, 114, 115, 116
 Aphides, 376
 Apodes, 310
 Appendages, 274, 276, 285
 Aptera, 261
 Arachnida, 44, 261, 273, 286, 287,
 288, 292, 298, 336, 337, 380
 Archæopteryx, 335 (ill.), 337, 350,
 351, 352, 366
 Aristotle, 175, 247, 249, 260
 Armadillos, 175
 Arteries, 130, 131, 132 (ill.), 133 (ill.),
 137, 138, 139, 140, 145, 147
 Aorta, 138, 145, 147, 284
 Branchial, 138
 Carotid, 138
 Cœliaco-mesenteric, 138
 Iliac, 138
 Pulmo-cutaneous, 138
 Pulmonary, 132 (ill.), 138, 144
 Renal, 138
 Subclavian, 138
 Systemic, 138
 Truncus arteriosus, 138, 147
 Arthropoda, 42, 261, 266, 271, 273,
 274, 279, 281 (ill.), 282, 283 (ill.),
 286, 287, 289, 291, 293, 296,
 297, 298, 302, 310, 311, 324, 334,
 337
 Ascidiacea, 328, 329
 Asexual reproduction, 22, 30
 Asteroidea, 312
 Astigmatism, 67
 Atomic principle, 188, 189
 Atrium, 137, 148, 327
 Attraction sphere, 177
 Auditory ossicles, 69 (ill.)
 Auricles, 132 (ill.), 133 (ill.), 136 (ill.),
 137, 138, 143, 144
 Auriculo-ventricular valve, 137, 138
 Aves (see also *Birds*), 44, 261, 289
Avicenna, 331
 Axial skeleton, 342
 Axolotl, 167, 168 (ill.)
 Bacteria, 121, 258, 259
Baer, von, 171
 Balanoglossus, 329
 Balantidium, 253
 Barnacle, 249 (ill.), 288 (ill.)

- Barry*, 257
Bastian, 259
Bateson, 204, 330
Batrachians, 298
Bayliss, 152
 Bee, 175, 261
 Behaviour, 73, 74, 92-97, 112
Bernard, Claude, 134
Berthelot, 118
Bidder's organ, 37
Bile, 116, 122
 Biogenesis, Principle of, 247-270
 Birds (see also *Aves*), 34, 59, 64, 82,
 134, 181, 291, 297
 Limb skeleton, 349
 skull, 361 (ill.)
Black, 127
 Bladder, 24 (ill.), 115 (ill.), 126
 Swim-bladder, 145
 Blood—
 Circulation of, 123, 129, 130, 131,
 132 (ill.), 133, 135, 137, 138, 139
 (ill.), 144, 145, 152, 283, 284
 Composition of, 134, 143
 Corpuscles, 142
 Regulation of flow of, 139-140, 141,
 152
 Bone, 54 (ill.)
Bower, 44
 Brachiopoda, 43, 292, 301, 311
 Brain, 65, 84, 86 (ill.), 87, 88, 92, 94,
 96, 153, 399
 Branchiostoma, 325
Bridges, 204, 215
 Bronchus, 116 (ill.), 123 (ill.)
Broom, 360
Browne, Sir Thomas, 184
 Bryozoa, 299, 318
Buchner, 118
Buckland, 333
 Buff Orpingtons, 187
 Buthidæ, 368, 369

 Caffeine, 152
 Calciferol, 109
 Calorimeter, 101
Calvin, 130
 Campodea, 276
 Capillaries, 123 (ill.), 129, 130, 131,
 134, 136, 137, 138, 139, 140, 141,
 144, 145
 Carbohydrates, 102, 103, 112, 114,
 134, 306
 Carbon dioxide, 77, 100, 101, 112,
 114, 123, 124, 127, 128, 129,
 284
 Carboniferous, 355, 356
 Carotin, 110
 Cartilage, 52, 54
 Caseinogen, 120
Castle, 171
 Castration, 174, 175
 Catalyst, 117, 118, 119, 120
Cavendish, 128
 Cells, 59, 65, 66, 79, 80, 81, 115, 177
 Cell theory, 171, 257, 258
 Cellular structure, 29 (ill.), 30,
 31 (ill.), 32, 35, 55, 57
 Central Nervous System (C.N.S.),
 78, 81, 82, 83, 87, 89 (ill.), 91,
 95, 152, 156, 157, 280, 281, 282,
 293, 302, 322, 324, 328, 330
 Cephalochorda, 325
 Cephalopoda, 44, 291, 299, 300, 301,
 303, 304 (ill.), 305 (ill.), 306, 308,
 310, 337
 Cestoda, 299, 320
 Cetacea, 266
 Chameleon, 18, 19, 40, 45, 47, 65, 84,
 85 (ill.), 86, 90
 Chelonian, 365
 Chemical products, 45
 Chemistry of body, 102-104
 Chitin, 293
 Chiton, 301 (ill.), 304, 305, 306, 307,
 308
 Chlamydomonas, 256
 Chlorophyll, 105, 112, 114, 256
 Chondrostei, 340
 Chordata, 324
 Chromatophores, 45, 46

- Chromosome, 176 (ill.), 177, 178 (ill.),
 179, 180 (ill.), 181, 182 (ill.),
 183 (ill.), 184, 185, 190, 191, 210,
 212, 214, 215, 219 (ill.), 223 (ill.),
 229
 Hypothesis, 200-227 (ill.)
 Map, 216-227, 375, 383, 384
Church, 44
 Cilia, 59, 62 (ill.), 250, 251, 256, 257,
 327
 Ciliary motion, 59
 muscle, 64 (ill.), 66
 Ciliata, 310
 Ciliated epithelium, 45, 59 (ill.)
 Circulation—
 Annelida, 302
 Arthropod, 302
 Fish, 145
 Frog, 134, 136
 Human, 143-144
 Mollusc, 302
 Vertebrate, 302
 Cirrhopoda, 292, 301
 Cladoselachus, 347
 Classification, Natural, 382, 387
 Climatius, 347
 Cloaca, 115 (ill.), 125
Clusius, 332
 Cochlea, 69 (ill.), 70, 88
 Cockroach, 182, 273, 274, 275, 276
 (ill.), 277 (ill.), 278, 279, 284
 Coelenterata, 43, 308, 311, 313, 315,
 316, 318
 Coelocanthini, 341
Cole, 332
 Coleoptera, 261
 Colour response, 19, 20, 67, 152, 153
 Conchifera, 300
 Conservation of Energy, 98-102
 Constancy, Law of, 197
 Contractile vacuoles, 251
 Co-ordination, 73-97
Cope, 334
 Corallaria or Polypi, 299
 Cornea, 64 (ill.), 65, 66, 67
Correns, 190
Costa, 325
 Cotylosauria, 356, 359, 360, 363, 364,
 365
 Crab, 175
 Crayfish, anatomy of, 272-273 (ill.),
 274, 278, 279, 285
 Crepidula, 306
 Cretinism, 105, 166
Crew, 185
 Crinoidea, 312
 Cross-breeding, 189, 198, 205, 212,
 228, 237
 Crossing-over, 220, 221 (ill.)
 Crustacea, 44, 261, 273, 279, 287,
 288, 289, 292, 298, 310
 Classification of, 389-393
 Cryptozoic, 380
 Crystalline style, 306
 Ctenidium, 300, 303, 304, 305, 308
 Ctenophora, 317
Cuvier, 204
Cuvier, 286, 291, 293, 300, 301, 311,
 332
 Cyclops, 279 (ill.)
 Cyclostomes, 148, 289, 341, 342, 344,
 352
 Cynognathus, 361, 364, 366
 Cytoplasm, 29 (ill.), 59 (ill.). 177

Dallinger, 259
Dalton, 188
 Daphnia, 279 (ill.)
Darwin, C., 189, 299, 300, 367, 368,
 372, 373, 375, 377, 378, 379, 380,
 382, 383, 386
Darwin, Erasmus, 367
 Devonian, 350, 354
De Vries, 190
 Diaphragm, 116 (ill.), 124
 Digestion, 114-123, 126-128, 129,
 134, 282
 Dinosaurs, 352
 skull, 361 (ill.), 364
 Dipnoi, 340, 347, 351
 Diptera, 261, 354

- Dobell*, 256
 Dogfish, 273, 274, 352
 Doliolum, 328
 Dominant, 194, 195
Doncaster, 212
Drosophila, 180 (ill.), 183 (ill.), 204, 210, 211 (ill.), 213 (ill.), 214, 220, 225, 227, 228, 237, 379, 381, 384, 385
Drysdale, 259
 Ductless glands, 150-154, 165 (see also *Glands*)

 Ear, 8, 21, 62, 64, 68-70 (ill.)
 Echidna, 268, 349
 Echinodermata, 43, 292, 299, 310, 311 (ill.), 312
 Echinoderms, 311, 312
 Echinoidea, 312
 Echivroidea, 295, 323
 Ectoderm, 156 (ill.)
 Ectoplasm, 251
Edwardes, Milne, 47, 297, 308
 Effector organs, 45-46, 73, 74, 78, 80
 Egg, 24, 25, 26, 27, 28 (ill.), 30, 31, 32, 34, 35, 36, 38, 39, 40, 41, 42, 103, 155, 158-162, 171, 179, 181, 186, 189, 190, 194, 197, 200
 Elasmobranchs, 338, 339 (ill.), 344
 Embryo, 30, 31, 35, 38, 39, 40, 111, 137, 145, 147, 155, 156, 158, 161, 162
 Endoplasm, 251
 Energy, 98-113, 114, 129
 Enteropneusta, 329, 330
 Entomozoa, 298
 Environment, 167
 Enzymes, 117, 118, 119, 120, 121, 306
 Epithelial folds, 164
 Epithelium, 32, 293
 Erepsin, 120, 122
 Euglena, 256
 Eurypterida, 334
 Eustacian tube, 68, 69 (ill.), 70, 115 (ill.)

 Evolution, 38
 Evolutionary theory to-day, 367-387
 Excretion, 101, 125-128
 Eye, 62, 64 (ill.), 65 (ill.), 66, 67 (ill.), 68, 88, 279, 280

 Fat, 102, 103, 104, 119, 122, 137, 142
 Fertilization, 25 (ill.), 26, 30, 35, 37, 38, 41, 42, 155, 172, 175, 177, 178, 186, 189, 190, 191, 192, 194, 197, 231, 376
 Fibres, 50, 51, 55, 66, 69, 70, 79, 80, 81, 82, 83, 84, 94, 115, 140, 143
Fischer, 102
 Fishes, 19, 25 (ill.), 40, 46, 47, 64, 82, 86, 134, 137, 144, 145, 146, 148, 158, 162, 291, 298, 325, 338, 339, 340, 341, 342, 344, 345, 346, 347, 350, 351, 356, 358
 Flagella, 256
Flourens, 70
 Fly, 94, 205-208 (ill.), 211-223
 Blow, 62
 Gall, 377
 Fruit, 180, 181, 183, 206, 207 (ill.)
 Stone, 180, 181 (see also *Drosophilia*)
 Fœtus, human, 163 (ill.)
 head, 359 (ill.)
Fol, 25
 Foraminifera, 253 (ill.), 332
Foster, 78 n.
 Fowl, 34, 35, 36, 103, 137, 158-162, 175, 188, 189, 194, 195, 209 (ill.), 237, 238, 239
 Frog (*Frontispiece*), 18, 19, 21, 23 (ill.), 24 (ill.), 27, 28 (ill.), 30, 32, 34, 35, 39, 42, 44, 46, 47, 49, 52 (ill.), 53 (ill.), 54, 55, 56, 57, 59, 62, 64, 65, 66, 68, 70, 73, 74, 75, 76, 77, 79, 80, 86, 88, 92, 94, 95, 96, 101, 102, 106, 107, 114, 115 (ill.), 123, 124, 125 (ill.), 129, 133 (ill.), 134, 135 (ill.), 136 (ill.), 137, 141 (ill.), 142, 143, 144, 146,

- 147, 150, 153, 155, 156, 157, 158,
161, 162, 164, 166, 167, 174, 175,
185, 253
- Galen*, 55, 78
- Ganglia*, 79, 81 (ill.), 82, 83, 84 (ill.),
86, 87, 90, 288, 293
- Ganoides*, 338 (ill.), 339, 340, 342, 356
- Gastric juice, 118, 120, 122, 126, 282
- Gastropoda, 44, 292, 299, 300, 301,
302, 303, 304 (ill.), 306, 307, 308,
310
- Genetic variation, 194
- Genetics, 187, 189, 234-242
- Genital organs, 37 (ill.)
- Genotype, 375
- Geographical distribution, 269-270,
368-373, 386
- Geotropism, 63
- Gephyrea, 323
- Gerard*, 248, 249
- Gill, 62, 147, 162, 163, 285, 300, 303,
306
arches, 144 (ill.), 146, 147, 163, 164
clefts, 145 (ill.), 146 (ill.), 164
- Glands, 32, 45, 57, 58 (ill.), 86, 142,
143, 150-154
- Glisson, 51
- Glycogen, 119, 122, 124, 131, 134, 137
- Goethe*, 367
- Goitre, 105
- Gomphognatus, 361
- Gonads, 27, 37, 170, 174, 175, 293
- Goodrich*, 172
- Græfian follicles, 33
- Gravity, 62, 63, 64, 72
- Gullet, 59, 115, 116 (ill.)
- Gut, 24 (ill.), 87, 89, 115, 129, 132
(ill.), 135 (ill.), 138, 145 (ill.)
Embryonic, 55, 156 (ill.), 157
- Haeckel*, 252, 318, 323, 324, 325
- Hæmocyanin, 105, 134, 283
- Hæmoglobin, 103, 105, 131, 134, 282,
293
- Hæmophilia, 383
- Haldane*, *J. B. S.*, 100, 101, 169, 170,
172, 383
- Harvey*, 130, 247
- Haswell*, 271 n.
- Haughton*, 360
- Head skeleton, 352-356
- Heart, 16 (ill.), 57, 86, 89, 106, 107,
121, 129, 130, 136, 137, 140,
141 (ill.), 144 (ill.)
- Auricles, 303
- Sinus venosus, 137
- Ventricles, 303
- Helmholtz*, 75
- Helminthes, 298
- Hemichorda, 325, 329, 330
- Henry*, 103
- Heredity, 167, 189, 193
- Hermaphroditism, 36, 37, 376
- Hertwig*, 25
- Heterozygous, 194, 195, 197, 378
- Hexapoda, 289 (see also *Insecta*)
- Hill*, *Croft*, 119
- Hirudinea, 43, 295
- Holothuroidea, 312
- Homo sapiens, 261 (see also *Man*)
- Homologous structures, 33
- Homology, 382, 396-398
- Homozygous, 194, 245
- Hooke*, *Robert*, 126
- Hormones, 152
- Huxley*, *Julian*, 100, 169, 170, 172
- Huxley*, *T. H.*, 325
- Hybrids, 189, 194, 200, 204, 206, 208
(ill.), 212, 245, 374, 375, 384
- Hydra, 313 (ill.), 315
- Hydroid, 315, 316
- Hydrozoa, 43, 316
- Hymenoptera, 40, 175, 261
- Hypermetropia, 67
- Ichthyosaurs, 365
- Infusoria, 258, 292, 299
- Inheritance—
machinery of, 186-242
problem of, 186-189

- Insecta, 44, 62, 64, 92, 93, 133, 134,
 175, 261, 275, 286, 287, 289, 292,
 298, 310, 337
 Key to order of insects, 394-395
 Intestine, 55, 57, 115 (ill.), 116 (ill.),
 117, 120, 122, 134, 140, 152
 Invertebrata, 105, 287, 291-330
 Iodine, 105, 106, 165, 166, 167
 Iris (pupil), 64 (ill.), 66
 Isogamy, 257
 Isopleura, 301, 306
- Joblot*, 258
Johannsen, 231
 Jurassic, 339, 341, 351, 361, 364
- Karoo, 360
 Kidneys, 24 (ill.), 27, 37 (ill.), 125
 (ill.), 126, 133 (ill.), 135 (ill.),
 137, 138, 251
Kovalevsky, 328
Kuhne, 118
- Lacteals, 142, 143 (ill.)
 Lactic acid, 124
Lamarck, 167, 286, 287, 367
 Lamarckian principle, 170-171, 172,
 174, 286, 287, 300, 318, 379
 Lamellibranchiata (see *Pelecypoda*)
 Lampreys, 280
Laplace, 128
 Larval period, 164, 175
 Latimeria, 341
Lavoisier, 127, 128
Leeuwenhoek, 24, 258
 Lepidoptera, 181, 212, 261
 Lepidostei, 341, 356
 Leptocardii, 325
Leuckart's Classification, 308-310, 312,
 316, 318
Liebig, 126
 Limax, 325
 Limb skeleton, 344-352
- Limulus, 334, 337, 380, 381
 Lingula, 381
Linnaeus, 260, 261, 286, 301
 system of, 261, 262-266, 286, 287,
 318, 325, 377
 Lipase, 120
 Liver, 57, 115 (ill.), 116 (ill.), 121, 122,
 132 (ill.), 134, 135 (ill.), 136, 138,
 145 (ill.), 282
 Lobster, 273
 Locust, 284
Loeb, Jacques, 41
 Lungs, 116 (ill.), 123, 124, 129,
 132 (ill.), 136, 137, 138, 144, 146,
 162
 book, 285
Lyell, 332
 Lymph, 142
- MacBride*, 271 n.
Magendie, 82
 Malacozoaria or Mollusca, 299
 Malpighian body, 126
 Mammalia, 44, 59, 64, 68, 82, 151,
 261, 266, 290, 291, 297
 skull of, 353 (ill.), 357
 Man, 64, 65, 68, 77, 87, 116, 123, 135,
 137, 141, 146, 150, 153, 165, 261
 Manometer, 127
 Matrix, 32, 54
Meckel, 171
 Meckel's cartilage, 353, 355, 359 (ill.)
 Medusa, 315
 Melanophores, 46 (ill.), 47, 48 (ill.),
 49, 153
 Mendelism, 189-200, 210, 228, 230
 Mesoderm, 156 (ill.), 157, 158 (ill.)
 Metabolism, 118
 Metamorphosis, 162 *et seq.*
 Sexual, 174-177
 Micro-organisms, 249-252, 255 (ill.)
 Mitosis, 32, 176 (ill.), 177
 Mollusca, 44, 300, 301, 302 (ill.),
 303 (ill.), 309, 310, 311
 Molluscoidea, 299, 300

- Monotremata, 349
 Monotreme, shoulder girdle of, 348
 (ill.)
Morgan, 204
 Moschops, 364
Müller, Johannes, 75, 81, 204
 Muscle, 50 (ill.), 51 (ill.), 55, 56, 66,
 71, 75, 76, 77, 80, 81, 86, 88, 115,
 124, 134, 140
 striped, 50, 55, 57, 80, 84 (ill.),
 85, 87, 88, 142
 Muscular Activity, 129, 134, 273
 Muscular movement, 50-52, 57 (ill.),
 124, 154
 Mussel, 62, 251
 Mutants, 167, 205, 206, 216, 219,
 245, 376, 377, 378, 379, 384
 Myopia, 67
 Myotomes or Myomeres, 346
 Myriapoda, 44, 261, 289, 298, 337,
 385
 Myzostomida, 295

 Nakahara, 180
 Nematelminthes, 43, 318, 324
 Nematocysts, 314
 Nemertina, 311, 320
 Nephridia, 293, 320
 Nerve Fibre, 70, 79, 87, 94
 afferent, 80, 81, 82, 83, 88, 90, 91
 cranial, 87
 efferent, 80, 81, 82, 88
 net, 314, 315
 Vagus, 140
 Nervous Impulse, 75, 76 (ill.), 77 (ill.),
 79, 80
 Nervous System, 74, 75, 78, 79, 83,
 88, 137, 150, 152, 153
 Neurones, 79, 80, 81, 83, 87, 88, 91,
 92, 94, 95
Newport, 155
 Notochord, 158 (ill.), 160 (ill.)
 Nucleus, 26, 29 (ill.), 30, 31 (ill.), 32,
 34, 35, 47, 55, 57, 59 (ill.)
 Division, 177-185 (ill.)
- Nucula, 300, 307
 Nummulites, 332

 Obelia, 315
 Oesophagus, 115, 116 (ill.)
 Olfactory nerve, 88, 91
 Oligochæta, 38, 43, 295
 Opalina, 253
 Ophivroidea, 312
 Opisthophthalmus, 369, 372
 Optic nerve, 64 (ill.), 65, 66, 86 (ill.),
 88, 90, 91 (ill.)
 Organisms, 57, 118
 classification of, 32, 34
 development of new, 155-185
 Osteolepidi, 341, 350, 351, 354, 356
 Osteozoaia, 297
 Ostia, 283, 284
 Ostracodermi, 345
 Ovaries, 24 (ill.), 27, 30, 31, 32, 33
 (ill.), 34, 36, 37 (ill.), 174
 Oviducts, 24 (ill.), 27, 30, 34, 37 (ill.),
 40
Owen, 300, 334
 Oxygen, 99, 100, 101, 102, 117, 148
 149, 259, 282, 285

 Palæontology, 332
Pallas, 325
 Pancreas, 115 (ill.), 120, 121, 122, 152,
 282
 Pancreatic juice, 152
Panniza, 82
 Parabuthus, 369
 Paramecium, 23 (ill.), 30, 59, 250,
 251, 252, 253, 254, 256, 257
 Parasites, 113
 Pariasaurus, 366
Parker, 271 n.
 Parthenogenesis, 40-43, 376
Pasteur, 258, 259
Pavlov, 96
Peau de Saint Gilles, 118

- Pelecypoda or Lamellibranchiata, 44,
 299, 300, 301, 302, 303, 306, 307
 Pellagra, 110
 Plasmatozoa, 310
 Penis, 37 (ill.)
 Pentadactyl limb, 345, 347 (ill.)
 Pepsin, 120
 Peripatus, 288, 293, 295, 296, 302
 Perla, 180
 Permian, 360, 361, 364, 365
 Pharyngobranchii, 325
Phillips, 171
 Phoronis, 311
 Physalia, 315
 Pigeons, 70, 273
 Pigmentary effector system, 45-49,
 65, 90 (ill.)
 Pigment cells, 153, 155, 156 (see also
 Melanophores)
 Pincal eye, 279, 280
 Pineal gland, 280
 Pinna, 68 (ill.)
 Pisces (see also *Fishes*), 44, 261, 289
 Pithecanthropus, 261
 Pituitary body, 86
 Pituitary gland, 92, 153, 165
 Placenta, 161
Plato, 247
 Platyhelminthes, 43, 318, 320
 Platypus, 40, 268 (ill.), 349, 364
 Plesiosaurs, 365
 Plumularia, 315
 Polar Bodies, 179 (ill.)
 Polychæta, 43, 294 (ill.), 295
 Polypi, 292, 308
 Polyploidy, 375, 376
 Polypterini, 341, 350
 Polyzoa, 43, 318, 322, 323 (ill.)
 Porifera, 43, 316, 317
Pouchet, 259
Priestley, 127, 131
 Prochordata, 325
 Proteins, 102, 103, 104, 105, 113, 117,
 120, 121
 Protista, 250, 252, 253, 256, 257
 Protoplasm, 253, 256
 Protoselachii, 341
 Protozoa, 253, 255, 257, 258
 Pseudopodia, 254, 256
 Pterobranchia, 330
 Pterodactyls, 267 (ill.)
 Pteropoda, 291, 299, 301
 Puberty, 174
 Pyrosoma, 328
 Rabbit, 55, 234-238
 Radiaria, 299
 Radiolaria, 253 (ill.)
 Reaction, reversibility of, 118, 119
 Reactivity, 17, 45, 49
 Receptivity, 18, 45
 Receptor organs, 20, 21, 62, 73, 74,
 78
 Recessive, 194
 Rectum, 115, 116 (ill.)
 Reflexes, 73, 74, 79, 81, 83, 84, 92,
 95, 96
 Rennet, 120
 Reproduction, 21-43, 34-38, 45
 Reptilia, 44, 289, 291, 297, 385
 Respiration, 112, 123-124 (ill.), 126-
 128
 Response, 45-73, 112
 Retina, 65, 66, 67, 91 (ill.)
 Rhynchocephalia, 361 (ill.), 364
Richter, 188
Roesel, 253
Romanes, 370
 Rotatoria, 299
 Rotifera, 40, 43, 175, 250, 258, 318,
 322, 323 (ill.)
 Sacculina, 175
 Sacculus, 69 (ill.), 70
St. Hilaire, 367
 Salamander, 46, 149, 167, 168 (ill.),
 175, 331, 332 (ill.), 340, 342, 344,
 370
 Saliva, 121, 122
 Salpa, 328

- Sarcodaria, 299
 Scaphognathite, 285
 Scaphopoda, 301, 307
Scheuchzer, 331, 332
Schleiden, 257
Schwann, 257
 Sciatic nerve, 75, 76, 79, 80, 87
 Scorpion, 273, 274, 275 (ill.), 279, 285, 336
 Scorpionidæ, 368, 369, 372
 Scrotum, 37
 Scutigera, 337, 380
 Scyphozoa, 43, 317
 Scytodermata, 310
 Secretin, 152
 Secretions, 45 (see also *Glands*), 57-59, 142, 153
Sedgwick, 271 n.
 Segmentation, 35, 39, 158, 175, 186, 287, 288, 291 (see also *Egg*)
 Segregation, principle of, 188, 189, 190, 198, 199 (ill.), 227-234 (ill.)
 Selachians, fins of, 343 (ill.)
 Selection, Theory of Natural, 373-387
 Seminal fluid, 24, 25, 29, 34, 35, 37, 38, 41, 174
 Sense organ, 20
Servetus, 130
 Sex Determination, 183, 184
 Sex organs, 39
 Sexual reproduction, 22-30, 34-38, 40-42, 111, 112, 252
Sherrington, Prof., 95
Shipley, 271 n.
 Shrimp, 63, 70, 71, 94
Siebold, 257
 Silurian, 341
 Sipunculoidea, 312, 323
Skaike, 197
 Skeleton: of the frog, 52, 53 (ill.), 54
 Skin, 46, 47, 57, 58, 129, 164
 Skull, 353-365
Spallanzani, Abbé, 43, 126, 128, 258
 Species, 38
 Spermathecae, 38
 Spermatozoa, 25, 26 (ill.), 27 (ill.), 30, 31, 32, 34, 35
 Sphenodon, 342, 344, 364, 365
 Spinal cord, 75, 78, 79, 80, 84, 85, 87, 90 (ill.), 94
 Spleen, 142
 Sponges (see *Porifera*)
 Spongiaria, 299
 Squamata, 365
Stannius, 82
Starling, 152
 Statocyst, 71 (ill.), 94
 Statolith, 70, 71 (ill.)
 Stegocephali, 341, 344, 351, 358 (ill.), 359, 360
 Stegocephalian, 340 (ill.), 356, 358
 skull of, 355
Stelluti, 250
Steno, 332
 Sterility, 111
 Stimulus, effect of, 21, 63, 64, 72, 73, 76, 78, 153
 Stomach, 55, 115 (ill.), 120
Sturtevant, 384
Subold, von, 287
 Succession, principle of, 269, 331-366, 368
 Sugar, 103, 119, 121, 134
Swammerdam, 56
 Sympathetic ganglia, 86, 89 (ill.), 90 (ill.)
 Synopsis, 83, 179, 217

 Tadpole, 25, 30, 32, 33, 42, 52, 54, 144, 162, 163, 164, 165 (ill.), 166 (ill.), 167, 352 (ill.)
 Teleostei, 339, 340, 344, 354
 Tendon, 28, 137
Terrel, 325
 Testes, 24, 27, 29, 31 (ill.), 32, 34, 36, 37 (ill.), 111, 133 (ill.), 174, 175
 Tetrapoda, 345, 346, 355, 358, 362
 Thaliacea, 328
 Therapsida, 360

- Thermopile, 42
 Thermopora, 360, 362, 363 (ill.)
Thompson, Vaughan, 322
 Thoracic duct, 142
 Thyroid Glands, 105, 106, 153 (ill.),
 164, 165, 166, 167, 174, 175
 Tissues, 32, 59, 66, 112, 129, 131,
 132 (ill.), 134, 137
 Toad, 37, 46, 48, 49, 57, 58, 70, 152,
 164, 167, 175
 Clawed (*Xenopus*), 20, 47, 48, 49, 67-8
 Trachea, 116, 123 (ill.), 134, 284, 285
 Trematoda, 320
 Triassic, 360, 361, 364
 Trilobita, 288
 Trilobites, 281 (ill.), 334, 336 (ill.),
 337, 380
 Trochophore, 306, 307 (ill.)
 Trypsin, 120, 122
Tschermak, 190
 Tunicata, 299, 300, 310, 318, 323, 324,
 325, 328, 329 (ill.)
 Turbellaria, 299, 320
 Turtle, 63, 64
 Tympanum, 68, 69, 70 (ill.)
Tyndall, 259
 Type, Principle of unity of, 259-269,
 271-330
- Ureter, 24 (ill.), 37 (ill.), 125 (ill.)
 Urethra, 37 (ill.), 127
 Urine, 27, 152
 Urinary bladder, 37 (ill.)
 Urochorda (see *Tunicata*)
 Uroplectes, 369
 Urostyle, 75
Ussher, Archbishop, 247
 Uterus, 37 (ill.), 40, 55
 Utriculus, 69 (ill.), 70, 88
- Vagina, 37 (ill.)
 Vas deferens, 37 (ill.)
- Vegetative reproduction, 22-23
 Veins, 129, 130, 132 (ill.)
 Abdominal, 135 (ill.), 136
 Azygos, 149
 Epigastric, 136
 Femoral, 135 (ill.), 136
 Hepatic, 135 (ill.)
 Hepatic portal, 132, 134, 135 (ill.),
 136, 137, 150, 284
 Jugular, 135, 142
 Musculo-Cutaneous, 135
 Postcaval, 135 (ill.), 137, 138, 150
 (ill.)
 Precaval, 135 (ill.)
 Pulmonary, 132 (ill.), 136 (ill.), 137,
 141
 Renal portal, 135 (ill.), 136, 151
 Sinus venosus, 135 (ill.), 136 (ill.),
 138, 151
 Subclavian, 135
 Veliger, 306, 307 (ill.)
 Venous circulation, 136, 137, 148,
 150 (ill.), 151
 Ventricle, 132 (ill.), 133 (ill.), 136 (ill.),
 137, 138, 144, 145, 147
 Vermes, 261, 266, 298, 310, 318 (see
 also *Worms*)
 Vertebral column, 52, 75, 90 (ill.)
 Vertebrata, 44, 64, 79, 82, 82, 84, 87,
 91, 114, 134, 149, 150, 151, 152,
 158, 261, 266, 271, 273, 278, 280,
 282, 287, 291, 297, 301, 310, 311,
 334, 337, 341
 Allies of, 324-325
 Skeleton of, 52
Vesalius, 51, 78
 Vitamins, 108-111, 121
Voltaire, 331
- Wallace*, 372, 373
Watson, 360
Warburg, 42
 White Leghorns, 187
Whytt, 78

- Wohler*, 102
Wolff, Caspar, 171
Worms, 38, 43, 134, 252, 291, 292, 293
 Flat (see also *Platyhelminthes*), 43,
 293, 318, 319 (ill.), 324
 Segmented (see *Annelida*)
 Thread (see also *Nemathelminthes*),
 321
- X-rays, 381
Xenophanes, 331
Xenopus, 20, 47, 48, 49, 67, 68
Yoldia, 305
Zoophyla, 318
Zoophytes, 299, 315



GEORGE ALLEN & UNWIN LTD
LONDON: 40 MUSEUM STREET, W.C.1
CAPE TOWN: 58-60 LONG STREET
TORONTO: 91 WELLINGTON STREET WEST
BOMBAY: 15 GRAHAM ROAD, BALLARD ESTATE
WELLINGTON N.Z.: 8 KINGS CRESCENT, LOWER HUTI
SYDNEY, N.S.W.: BRADBURY HOUSE, 55 YORK STREET

